

Roland® *DUAL TRIGGER PAD PDX-8* Owner's Manual



Thank you, and congratulations on your choice of the Roland PDX-8.

Before using the PDX-8, carefully read the sections entitled: "USING THE UNIT SAFELY" and "IMPORTANT NOTES" (p. 2; p. 3). These sections provide important information concerning the proper operation of the unit. Additionally, in order to feel assured that you have gained a good grasp of every feature provided by your new unit, this owner's manual should be read in its entirety. The manual should be saved and kept on hand as a convenient reference.

VERY IMPORTANT!!!

- BEFORE playing the pad, you must tension the head. See Page 4.
- Trigger type and trigger parameters in the sound module must be adjusted. See Page 5.
- Adjust the Rim Sensitivity in the sound module. See page 5.

Contents of the Package

- PDX-8 (pad unit)
- Connection Cable
- Tuning Key
- Owner's Manual (this manual)

Names of Components

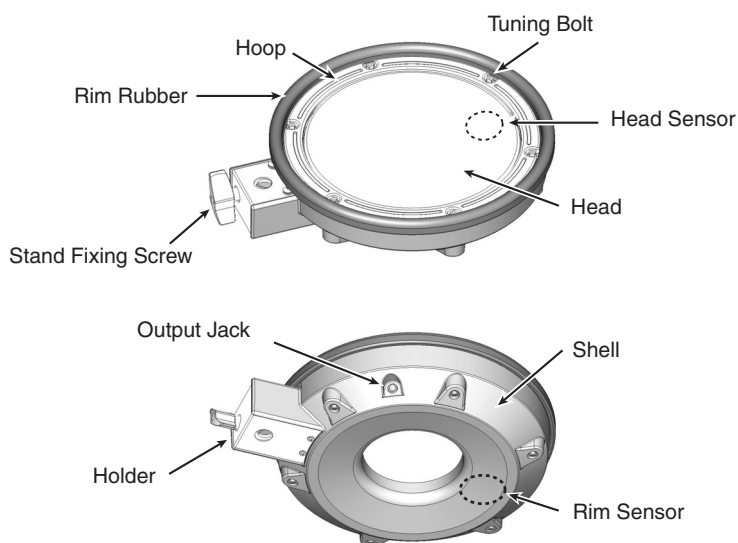



Copyright © 2006 ROLAND CORPORATION



All rights reserved. No part of this publication may be reproduced in any form without the written permission of ROLAND CORPORATION.









USING THE UNIT SAFELY

INSTRUCTIONS FOR THE PREVENTION OF FIRE, ELECTRIC SHOCK, OR INJURY TO PERSONS

About  WARNING and  CAUTION Notices







 WARNING	Used for instructions intended to alert the user to the risk of death or severe injury should the unit be used improperly.
 CAUTION	Used for instructions intended to alert the user to the risk of injury or material damage should the unit be used improperly. * Material damage refers to damage or other adverse effects caused with respect to the home and all its furnishings, as well to domestic animals or pets.

About the Symbols





	The  symbol alerts the user to important instructions or warnings. The specific meaning of the symbol is determined by the design contained within the triangle. In the case of the symbol at left, it is used for general cautions, warnings, or alerts to danger.
	The  symbol alerts the user to items that must never be carried out (are forbidden). The specific thing that must not be done is indicated by the design contained within the circle. In the case of the symbol at left, it means that the unit must never be disassembled.
	The  symbol alerts the user to things that must be carried out. The specific thing that must be done is indicated by the design contained within the circle. In the case of the symbol at left, it means that the power-cord plug must be unplugged from the outlet.

ALWAYS OBSERVE THE FOLLOWING



WARNING

- Before using this unit, make sure to read the instructions below, and the Owner's Manual. 
- Do not open or perform any internal modifications on the unit. (The only exception would be where this manual provides specific instructions which should be followed in order to put in place user-installable options; see p. 7.) 
- Do not attempt to repair the unit, or replace parts within it (except when this manual provides specific instructions directing you to do so). Refer all servicing to your retailer, the nearest Roland Service Center, or an authorized Roland distributor, as listed on the "Information" page. 
- Never use or store the unit in places that are:
 - Subject to temperature extremes (e.g., direct sunlight in an enclosed vehicle, near a heating duct, on top of heat-generating equipment); or are 
 - Damp (e.g., baths, washrooms, on wet floors); or are 
 - Humid; or are
 - Exposed to rain; or are
 - Dusty; or are
 - Subject to high levels of vibration.
- This unit should be used only with a stand (MDS series) that is recommended by Roland (p. 7). 

WARNING

- When using the unit with a stand (MDS series) recommended by Roland, the stand must be carefully placed so it is level and sure to remain stable. If not using a stand, you still need to make sure that any location you choose for placing the unit provides a level surface that will properly support the unit, and keep it from wobbling. 
- Do not allow any objects (e.g., flammable material, coins, pins); or liquids of any kind (water, soft drinks, etc.) to penetrate the unit. 

- In households with small children, an adult should provide supervision until the child is capable of following all the rules essential for the safe operation of the unit. 
- Protect the unit from strong impact. (Do not drop it!) 

CAUTION

- Try to prevent cords and cables from becoming entangled. Also, all cords and cables should be placed so they are out of the reach of children. 
- Never climb on top of, nor place heavy objects on the unit. 

CAUTION

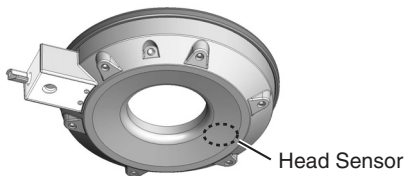
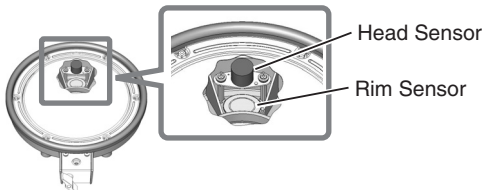
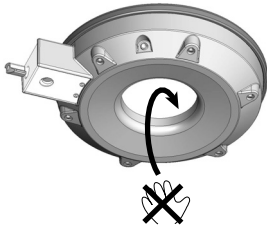
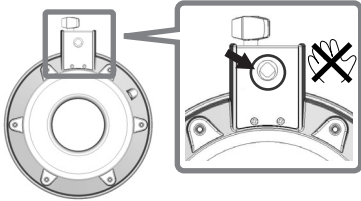
- Should you remove screws, keep them in a safe place out of children's reach, so there is no chance of them being swallowed accidentally.
- Do NOT place your fingers inside the shell, as you may hurt yourself or cause damage to the PDX-8. Or when changing the head, do NOT touch any of the internal parts. Also, do not insert your fingers into the hole of the mounting bracket.



IMPORTANT NOTES

In addition to the items listed under “USING THE UNIT SAFELY” on page 2–3, please read and observe the following:

Placement

- Do not expose the unit to direct sunlight, place it near devices that radiate heat, leave it inside an enclosed vehicle, or otherwise subject it to temperature extremes. Excessive heat can deform or discolor the unit.
- Do not allow rubber, vinyl, or similar materials to remain on the unit for long periods of time. Such objects can discolor or otherwise harmfully affect the finish.

Maintenance

- For everyday cleaning wipe the unit with a soft, dry cloth or one that has been slightly dampened with water. To remove stubborn dirt, use a cloth impregnated with a mild, non-abrasive detergent. Afterwards, be sure to wipe the unit thoroughly with a soft, dry cloth.
- Never use benzine, thinners, alcohol or solvents of any kind, to avoid the possibility of discoloration and/or deformation.

Additional Precautions

- Use a reasonable amount of care when using the unit's buttons, sliders, or other controls; and when using its jacks and connectors. Rough handling can lead to malfunctions.
- When connecting / disconnecting all cables, grasp the connector itself—never pull on the cable. This way you will avoid causing shorts, or damage to the cable's internal elements.
- To avoid disturbing your neighbors, try to keep the unit's volume at reasonable levels. You may prefer to use headphones, so you do not need to be concerned about those around you (especially when it is late at night).
- This instrument is designed to minimize the extraneous sounds produced when it's played. However, since sound vibrations can be transmitted through floors and walls to a greater degree than expected, take care not to allow these sounds to become a nuisance to neighbors, especially when performing at night and when using headphones.
- Due to the nature of the materials used in the sensor, changes in room temperature may affect the sensitivity of the sensor.

Main Feature

The PDX-8's light weight and compact design allows for comfortable performance and quiet response, even when playing rim shots.

Adjusting the Head Tension

Before using the pad, tighten the head so that the tension is rather firm.

Looseness in the head tension may result in problems such as failure of the PDX-8's rim shots to sound or double triggering.

NOTE

Striking the head when the head tension is loose may damage the sensor.

1. Use the included tuning key to tighten the tuning bolts.

Strike the head to check the feel and response.

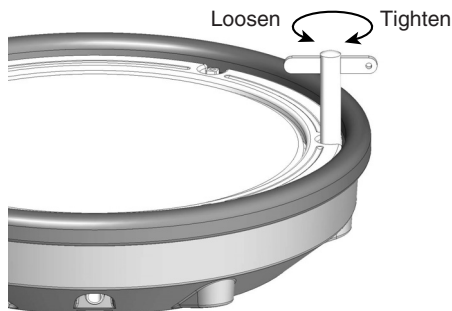

NOTE

Tighten each tuning bolt one by one, observing the numerical order shown in the diagram. Do not firmly tighten a single tuning bolt by itself. Doing so will make it impossible to tension the head evenly, and will cause malfunctions.

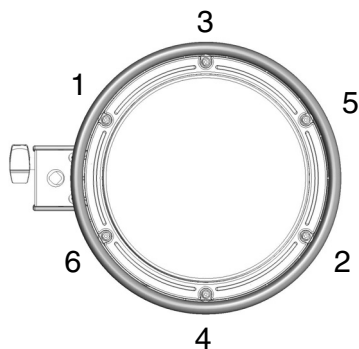

2. Fine-tune the adjustment while continuing to check the pad feel and response.

MEMO

- On the PDX-8, adjusting the head tension affects only the head response, and does not change the pitch of the sound as it would on an acoustic drum.
- Head tension may slacken with the passage of time. Readjust the tension as needed.

Attaching the Pad to a Stand

Attach the PDX-8 to a pad mount of the stand (MDS series).

NOTE

Be sure to tighten the stand fixing screw securely. If it remain loose, double triggering may occur.

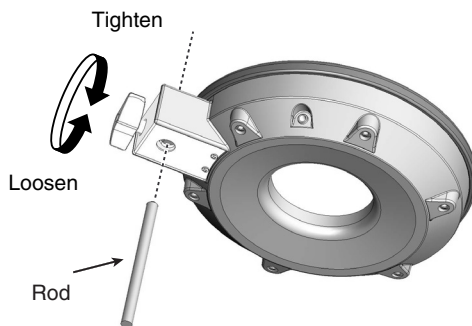

MEMO

When attaching the PDX-8 to a tom stand, check the dimensions of the rod. Depending on the dimensions of the rod, it may not be possible to attach the pad to the stand.

**Acceptable rod diameters:
9–11.5 mm (3/8 to 1/2 inch)**

Connecting To A Percussion Sound Module

Use the included stereo cable to make connections.

- If you use a monaural cable, you won't be able to employ rim shot and cross stick playing techniques.
- Connect the L-shaped plug of the included cable to the PDX-8.

** To prevent malfunction and/or damage to speakers or other devices, always turn down the volume, and turn off the power on all devices before making any connections.*

Trigger Settings For Percussion Sound Module

Set the trigger type and trigger parameters for the percussion sound module you are using.

Be sure to make these settings to ensure that the PDX-8 performs properly.

Below you will find the settings recommended for different percussion sound modules.

For instructions on setting the trigger parameters, refer to the Owner's Manual for your percussion sound module.

** Leave the initial Cross Stick Cancel settings for each module unchanged.*

About the Head Tension

Tighten the head so that the tension is rather firm.

Looseness in the head tension may result in problems such as failure of the PDX-8's rim shots to sound or double triggering.

About Rim Sens (*1)

If any of the following problems occurs, adjust Rim Sens to a value in the range indicated in the column for the corresponding percussion sound module.

- If the rim sound plays even when you strike the head, lower the Rim Sens value.
- If no rim sound plays even when the rim is struck forcefully, increase the Rim Sens value.

** When using the TD-12 and TD-20, adjust the "RimShot Adjust."*

TD-3 (Percussion Sound Module)

IMPORTANT: Only the snare input is capable of producing a rim shot.

Trigger Type (TYPE)	80r
Scan Time (Scan)	1.0
Mask Time (Mask)	8
Rim Sensitivity (RMS)	10 (*1)
Rim Gain (RNG)	1.1

TD-6V (Percussion Sound Module)

IMPORTANT: Only the 2(snare) input is capable of producing a rim shot.

TrigTyp	PD-80R
Mask Time	8ms
Rim Sens	11 (*1)

TD-12/TD-20 (Percussion Sound Module)

IMPORTANT: Only the inputs listed below are capable of producing a rim shot.

TD-12: 2 (SNARE), 3-5 (TOM1-3), 11-12 (AUX1-2)

TD-20: 2 (SNARE), 3-6 (TOM1-4), 12-15 (AUX1-4)

Trig Type	PD80R or PD85
Sensitivity	7
RimShot Adjust	1.8 (*1)

Setting when connecting with trigger input 2(SNARE)

The PDX-8 does not support the TD-12's and TD-20's positional sensing. Set the TD-12/TD-20 so that strike position sensing is not activated. Set Snare CC to "OFF."

(press [SETUP], then [F1 (MIDI)], then [F3 (CTRL)])

Playing Methods

Head Shots

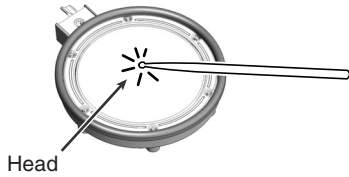

* Do not strike the hoop.

Rim Shots

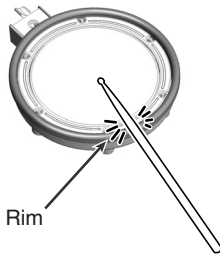

* To play rim shots, strike the rim in the area shown in the diagram.

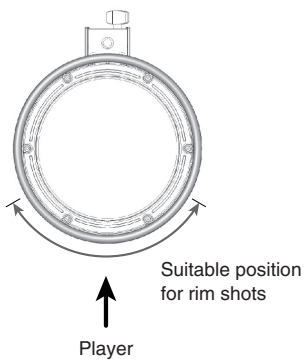

Cross Stick

Only strike the rim of the pad.

Depending on the instrument assigned to the rim, you can play rim shots and/or cross stick sounds.

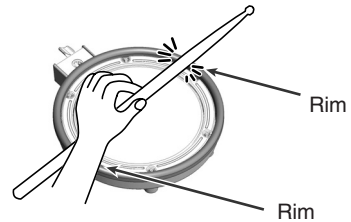

* To play the cross stick, be sure that you only strike the rim of the pad. Placing your hand on the head of the pad might prevent the cross stick sound from being played properly.

* For more on settings and instruments, see the respective module's owner's manual.

Head Replacement

When the Head Should Be Replaced

The head is an expendable item that eventually will wear out and need to be replaced. Replace the head when the following occurs:

Slack portions remain in the head even when the head tension is properly adjusted.

Replacement heads (optional): MH-8 Mesh Head

Replacing the Head

1. Remove all tuning bolts from the PDX-8.

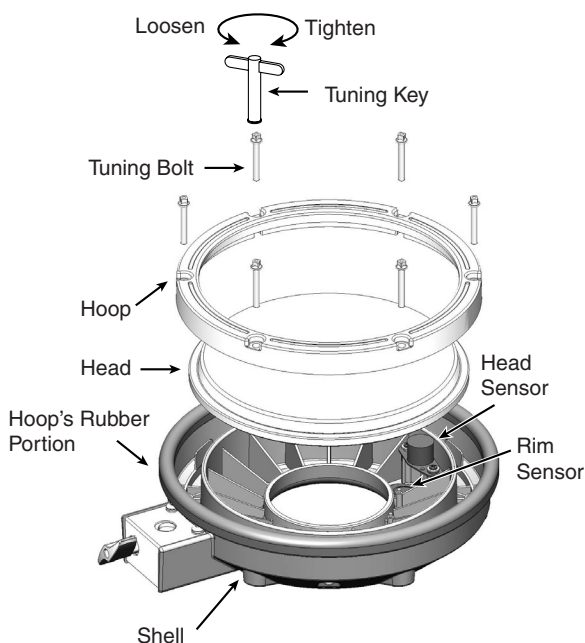

NOTE

Do not apply excessive force to the sensor and cushion located under the head. Doing so can interfere with accurate detection, and may damage it.

2. Remove the hoop.

3. Remove the old head.

4. Place the new head on the shell.

5. Place the hoop onto the head.

6. Attach the tuning bolts to the hoop and shell.

7. Next, adjust the tension of the head. Refer to "Adjusting the Head Tension" (p. 4).

NOTE

Do not firmly tighten a single tuning bolt by itself. Doing so will make it impossible to tension the head evenly, and will cause malfunctions.

Specifications

PDX-8

Head Size: 8 inches

Triggers: 2 (Head, Rim)

Dimensions: 266 (W) x 326 (D) x 62 (H) mm

10-1/2 (W) x 12-7/8 (D) x 2-1/2 (H)
inches

Weight: 1.3 kg

2 lbs 14 oz

Accessories: Owner's Manual, Connection Cable,
Tuning Key

Options: Mesh Head (MH-8),
Pad Mount (MDH-10U),
Drum Stands (MDS-3C, MDS-6C,
MDS-12, MDS-20)

* In the interest of product improvement, the specifications and/or appearance of this unit are subject to change without prior notice.

* The Rim rubber is one component that eventually wears out (the more so if numerous rim shots are performed), and will require replacement. Rim shots may not be performed correctly when the rim rubber is worn out. If this occurs, replace the rim rubber. Consult Roland Service for more on replacing the rim rubber.

Information

When you need repair service, call your nearest Roland Service Center or authorized Roland distributor in your country as shown below.

AFRICA

EGYPT

A1 Fanny Trading Office
9, EBN Hagar A1 Askalany
Street,
ARD El Golf, Heliopolis,
Cairo 11341, EGYPT
TEL: 20-2-417-1828

REUNION

MAISON FO - YAM Marcel
25 Rue Jules Hermann,
Chaudron - BP79 97 491
Ste Clotilde Cedex,
REUNION ISLAND
TEL: (0262) 218-429

SOUTH AFRICA

T.O.M.S. Sound & Music
(Pty)Ltd.
2 ASTRON ROAD DENVER
JOHANNESBURG ZA 2195,
SOUTH AFRICA
TEL: (011)417 3400
FAX: (011)417 3462

Paul Bothner(PTY)Ltd.
Royal Cape Park, Unit 24
Londonderry Road, Ottery 7800
Cape Town, SOUTH AFRICA
TEL: (021) 799 4900

ASIA

CHINA

Roland Shanghai Electronics
Co.,Ltd.
5F. No.1500 Pingliang Road
Shanghai 200090, CHINA
TEL: (021) 5580-0800

Roland Shanghai Electronics
Co.,Ltd.
(BEIJING OFFICE)

10F. No.18 3 Section Anhuaxili
Chaoyang District Beijing
100011 CHINA
TEL: (010) 6426-5050

HONG KONG

Tom Lee Music Co., Ltd.
Service Division
22-32 Fun Shan Street, Tsuen
Wan, New Territories,
HONG KONG
TEL: 2415 0911

Parsons Music Ltd.
8th Floor, Railway Plaza, 39
Chatham Road South, T.S.T,
Kowloon, HONG KONG
TEL: 2333 1863

INDIA

Rivera Digitec (India) Pvt. Ltd.
409, Nirman Kendra
Mahalaxmi Flats Compound
Off. Dr. Edwin Moses Road,
Mumbai-400011, INDIA
TEL: (022) 2493 9051

INDONESIA

PT Citra IntiRama
J1. Cideng Timur No. 15J-150
Jakarta Pusat
INDONESIA
TEL: (021) 6324170

KOREA

Cosmos Corporation
1461-9, Seocho-Dong,
Seocho Ku, Seoul, KOREA
TEL: (02) 3486-8855

MALAYSIA

Roland Asia Pacific Sdn. Bhd.
45-1, Block C2, Jalan PJU 1/39,
Dataran Prima, 47301 Petaling
Jaya, Selangor, MALAYSIA
TEL: (03) 7805-3263

PHILIPPINES

G.A. Yupangco & Co. Inc.
339 Gil J. Puyat Avenue
Makati, Metro Manila 1200,
PHILIPPINES
TEL: (02) 899 9801

SINGAPORE

SWEET LEE MUSIC
COMPANY PTE. LTD.
150 Sims Drive,
SINGAPORE 387381
TEL: 6846-3676

TAIWAN

ROLAND TAIWAN
ENTERPRISE CO., LTD.
Room 5, 9th. No. 112 Chung
Shan N.Road Sec.2, Taipei,
TAIWAN, R.O.C.
TEL: (02) 2561 3339

THAILAND

Theora Music Co., Ltd.
330 Soi Verng NakornKasem,
New Road, Sumpantawongse,
Bangkok 10100, THAILAND
TEL: (02) 224-8821

AUSTRALIA/ NEW ZEALAND

**AUSTRALIA/
NEW ZEALAND**
Roland Corporation
Australia Pty.,Ltd.
38 Campbell Avenue
Dee Why West. NSW 2099
AUSTRALIA

For Australia
Tel: (02) 9982 8266
For New Zealand
Tel: (09) 3098 715

CENTRAL/LATIN AMERICA

ARGENTINA

Instrumentos Musicales S.A.
Av.Santa Fe 2055
(1123) Buenos Aires
ARGENTINA
TEL: (011) 4508-2700

BARBADOS

A&B Music Supplies LTD
12 Webster Industrial Park
Wilkey, St.Michael, Barbados
TEL: (246)430-1100

BRAZIL

Roland Brasil Ltda.
Rua San Jose, 780 Sala B
Parque Industrial San Jose
Cotia - Sao Paulo - SP, BRAZIL
TEL: (011) 4615 5666

CHILE

Comercial Fancy II S.A.
Rut: 96.919.420-1
Natalien Cox #739, 4th Floor
Santiago - Centro, CHILE
TEL: (02) 688-9540

COLOMBIA

Centro Musical Ltda.
Cra 43 B No 25 A 41 Bododega 9
Medellin, Colombia
TEL: (574)3812529

COSTA RICA

JUAN Bansbach Instrumentos
Musicales
Ave.1. Calle 11, Apartado
10237,
San Jose, COSTA RICA
TEL: 258-0211

CURACAO

Zeelandia Music Center Inc.
Orionweg 30
Curacao, Netherland Antilles
TEL:(305)5926866

DOMINICAN REPUBLIC

Instrumentos Fernando Giraldez
Calle Proyecto Central No.3
Ens-La Esperilla
Santo Domingo,
Dominican Republic
TEL:(809) 683 0305

ECUADOR

Mas Musica
Rumichaca 822 y Zaruma
Guayaquil - Ecuador
TEL:(593-4)2302364

EL SALVADOR

OMNI MUSIC
75 Avenida Norte y Final
Alameda Juan Pablo II,
Edificio No.4010 San Salvador,
EL SALVADOR
TEL: 262-0788

GUATEMALA

Casa Instrumental
Calzada Roosevelt 34-01,zona 11
Ciudad de Guatemala
Guatemala
TEL:(502) 599-2888

HONDURAS

Almacen Pajaro Azul S.A. de C.V.
B.O.Paz Barahona
3 Ave.11 Calle S.O
San Pedro Sula, Honduras
TEL: (504) 553-2029

MARTINIQUE

Musique & Son
Z.I.Les Mangle
97232 Le Lamantin
Martinique F.W.I.
TEL: 596 596 426860

Gigamus SARL

10 Rue De La Folie
97200 Fort De France
Martinique F.W.I.
TEL: 596 596 715222

MEXICO

Casa Veerkamp, s.a. de c.v.
Av. Toluca No. 323, Col. Olivar
de los Padres 01780 Mexico
D.F. MEXICO
TEL: (556) 5668-6699

NICARAGUA

Bansbach Instrumentos
Musicales Nicaragua
Altamira D'Este Calle Principal
de la Farmacia 5ta.Avenida
1 Cuadra al Lago-#503
Managua, Nicaragua
TEL: (505)277-2557

PANAMA

SUPRO MUNDIAL, S.A.
Boulevard Andrews, Albrook,
Panama City, REP. DE
PANAMA
TEL: 315-0101

PARAGUAY

Distribuidora De
Instrumentos Musicales
J.E. Olear y ESQ. Manduvira
Asuncion PARAGUAY
TEL: (595) 21 492147

PERU

Audionet
Distribuciones Musicales SAC
Juan Fanning 530
Miraflores
Lima - Peru
TEL: (511) 4461388

TRINIDAD

AMR Ltd
Ground Floor
Maritime Plaza
Barataria Trinidad W.I.
TEL: (868) 638 6385

URUGUAY

Todo Musica S.A.
Francisco Acuna de Figueroa
1771
C.P.: 11.800
Montevideo, URUGUAY
TEL: (02) 924-2335

VENEZUELA

Instrumentos Musicales
Allegro,C.A.
Av. las industrias edf.Guitar
import
#7 zona Industrial de Turumo
Caracas, Venezuela
TEL: (212) 244-1122

EUROPE

AUSTRIA

Roland Elektronische
Musikinstrumente HmbH.
Austrian Office
Eduard-Bodem-Gasse 8,
A-6020 Innsbruck, AUSTRIA
TEL: (0512) 26 44 260

BELGIUM/FRANCE/ HOLLAND/ LUXEMBOURG

Roland Central Europe N.V.
Houtstraat 3, B-2260, Oevel
(Westerlo) BELGIUM
TEL: (014) 575811

CROATIA

ART-CENTAR
Degenova 3,
HR - 10000 Zagreb
TEL: (1) 466 8493

CZECH REP.

CZECH REPUBLIC
DISTRIBUTOR s.r.o
Votárova 247/16
CZ - 180 00 PRAHA 8,
CZECH REP.
TEL: (2) 830 20270

DENMARK

Roland Scandinavia A/S
Nordhavnsvej 7, Postbox 880,
DK-2100 Copenhagen
DENMARK
TEL: 3916 6200

FINLAND

Roland Scandinavia AS, Filial
Finland
Elanontie 5
FIN-01510 Vantaa, FINLAND
TEL: (09) 68 24 020

GERMANY

Roland Elektronische
Musikinstrumente HmbH.
Oststrasse 96, 22844
Norderstedt, GERMANY
TEL: (040) 52 60090

GREECE/CYPRUS

STOLLAS S.A.
Music Sound Light
155, New National Road
Patras 26442, GREECE
TEL: 2610 435400

HUNGARY

Roland East Europe Ltd.
Warehouse Area "DEPO" Pf.83
H-2046 Torokbalint,
HUNGARY
TEL: (23) 511011

IRELAND

Roland Ireland
G2 Calmount Park, Calmount
Avenue, Dublin 12
Republic of IRELAND
TEL: (01) 4294444

ITALY

Roland Italy S. p. A.
Viale delle Industrie 8,
20020 Arese, Milano, ITALY
TEL: (02) 937-78300

NORWAY

Roland Scandinavia Avd.
Kontor Norge
Lilleakerveien 2 Postboks 95
Lilleaker N-0216 Oslo
NORWAY
TEL: 2273 0074

POLAND

ROLAND POLSKA SP. Z O.O.
Ul. Gibraltarska 4,
PL-03 664 Warszawa
POLAND
TEL: (022) 679 4419

PORTUGAL

Roland Iberia, S.L.
Portugal Office
Cais das Pedras, 8/9-1 Dto
4050-465, Porto, PORTUGAL
TEL: 22 608 00 60

ROMANIA

FBS LINES
Piata Libertatii 1,
535500 Gheorgheni,
ROMANIA
TEL: (266) 364 609

RUSSIA

MuTek
Dorozhnaya ul.3,korp.6
117 545 Moscow, RUSSIA
TEL: (095) 981-4967

SLOVAKIA

DAN Acoustic s.r.o.
Povazská 18,
SK - 940 01 Nové Zámky
TEL: (035) 6424 330

SPAIN

Roland Iberia, S.L.
Paseo Garcia Faria, 33-35
08005 Barcelona SPAIN
TEL: 93 493 91 00

SWEDEN

Roland Scandinavia A/S
SWEDISH SALES OFFICE
Danvik Center 28, 2 tr.
S-131 30 Nacka SWEDEN
TEL: (08) 702 00 20

SWITZERLAND

Roland (Switzerland) AG
Landstrasse 5, Postfach,
CH-4452 Ittingen,
SWITZERLAND
TEL: (061) 927-8383

UKRAINE

EURHYTHMICS Ltd.
P.O.Box: 37-a
Nedecye Str. 30
UA - 89600 Mukachevo,
UKRAINE
TEL: (03131) 414-40

UNITED KINGDOM

Roland (U.K.) Ltd.
Atlantic Close, Swansea
Enterprise Park, SWANSEA
SA7 9PJ,
UNITED KINGDOM
TEL: (01792) 702701

MIDDLE EAST

BAHRAIN

Moon Stores
No.16, Bab Al Bahrain Avenue,
P.O.Box 247, Manama 304,
State of BAHRAIN
TEL: 17 211 005

IRAN

MOCO INC.
No.41 Nike St., Dr.Shariyati Ave.,
Robeyto Geraha Mirdamad
Tehran, IRAN
TEL: (021) 285-4169

ISRAEL

Haliit P. Greenspoon & Sons
Ltd.
8 Retzif Ha'aliya Hashnya St.
Tel-Aviv-Yafo ISRAEL
TEL: (03) 6823666

JORDAN

MUSIC HOUSE CO. LTD.
FREDDY FOR MUSIC
P. O. Box 922846
Amman 11192 JORDAN
TEL: (06) 5692696

KUWAIT

EASA HUSAIN AL-YOUSIFI
& SONS CO.
Abdullah Salem Street,
Safat, KUWAIT
TEL: 243-6399

LEBANON

Chahine S.A.L.
Rumge Zeidan St., Chahine
Bldg., Achrafieh, P.O.Box: 16-
5857,
Beirut, LEBANON
TEL: (01) 20-1441

OMAN

TALENTZ CENTRE L.L.C.
Malatan House No.1
Al Noor Street, Ruwi
SULTANATE OF OMAN
TEL: 2438 3443

QATAR

**Al Emadi Co. (Badie Studio &
Stores)**
P.O. Box 62, Doha, QATAR
TEL: 4423-554

SAUDI ARABIA

aDawlah Universal
Electronics APL
Corniche Road, Aldossary
Bldg., 1st Floor, Alkhubar,
SAUDI ARABIA

P.O.Box 2154, Alkhubar 31952
SAUDI ARABIA
TEL: (03) 898 2081

SYRIA

Technical Light & Sound
Center
Rawda, Abdul Qader Zajzari St.
Bldg. No. 21, P.O.BOX 13520,
Damascus, SYRIA
TEL: (011) 223-5384

TURKEY

ZUHAL DIS TICARET A.S.
Galip Dede Cad. No.37
Beyoglu - Istanbul / TURKEY
TEL: (0212) 249 85 10

U.A.E.

Zak Electronics & Musical
Instruments Co. L.L.C.
Zabeel Road, Al Sherooq Bldg.,
No. 14, Grand Floor, Dubai,
U.A.E.
TEL: (04) 3360715

NORTH AMERICA

CANADA

Roland Canada Ltd.
(Head Office)
5480 Parkwood Way
Richmond B. C., V6V 2M4
CANADA
TEL: (604) 270 6626

Roland Canada Ltd.

(Toronto Office)
170 Admiral Boulevard
Mississauga ON L5T 2N6
CANADA
TEL: (905) 362 9707

U. S. A.

Roland Corporation U.S.
5100 S. Eastern Avenue
Los Angeles, CA 90040-2938,
U. S. A.
TEL: (323) 890 3700