

AirDrive 2.4 Pocket, 5-pin XLR

Product code: 50260

Preface

Thank you for purchasing this Showtec product.

The purpose of this user manual is to provide instructions for the correct and safe use of this product.

Keep the user manual for future reference as it is an integral part of the product. The user manual shall be stored at an easily accessible location.

This user manual contains information concerning:

- Safety instructions
- Intended and non-intended use of the device
- Installation and operation of the device
- Maintenance procedures
- Troubleshooting
- Transport, storage and disposal of the device

Non-observance of the instructions in this user manual may result in serious injuries and damage of property.

©2025 Showtec. All rights reserved.

No part of this document may be copied, published or otherwise reproduced without the prior written consent of Highlite International.

Design and product specifications are subject to change without prior notice.

For the latest version of this document or other language versions, please visit our website www.highlite.com or contact us at service@highlite.com.

Highlite International and its authorized service providers are not liable for any injury, damage, direct or indirect loss, consequential or economic loss or any other loss arising from the use of, or inability to use or reliance on the information contained in this document.

Highlite International B.V. – Vestastraat 2 – 6468 EX Kerkrade – the Netherlands

Table of contents

1. Introduction	3
1.1. Before Using the Product.....	3
1.2. Intended Use.....	3
1.3. Text Conventions.....	3
1.4. Symbols and Signal Words.....	4
1.5. Symbols on the Information Label.....	4
2. Safety	5
2.1. Warnings and Safety Instructions.....	5
2.2. Requirements for the User.....	6
3. Description of the Device	7
3.1. Top View.....	7
3.2. Bottom View.....	8
3.3. Product Specifications.....	9
3.4. Dimensions.....	10
3.5. Optional Accessories.....	10
4. Installation	11
4.1. Safety Instructions for Installation.....	11
4.2. Personal Protective Equipment.....	11
4.3. Installation Site Requirements.....	11
4.4. Mounting Options.....	12
4.4.1. Mounting on a Microphone Stand.....	12
4.4.2. Mounting with a Clamp.....	13
4.5. Installing the Antenna.....	13
4.6. Line of Sight.....	14
4.7. Connecting to Power Supply.....	15
5. Setup and Operation	16
5.1. Warnings and Precautions.....	16
5.2. Setup Example.....	16
5.3. Setup as Signal Booster.....	17
5.4. Change the Transmitter/Receiver Mode.....	18
5.5. Connecting and Disconnecting Multiple Devices.....	18
5.6. Restore Factory Settings.....	18
5.7. DMX Connection.....	18
5.7.1. DMX-512 Protocol.....	18
5.7.2. DMX Cables.....	19
6. Troubleshooting	20
7. Maintenance	21
7.1. Preventive Maintenance.....	21
7.1.1. Basic Cleaning Instructions.....	21
7.2. Corrective Maintenance.....	21
8. Deinstallation, Transportation and Storage	22
8.1. Instructions for Deinstallation.....	22
8.2. Instructions for Transportation.....	22
8.3. Storage.....	22
9. Disposal	22
10. Approval	22

1. Introduction

1.1. Before Using the Product



Important
Read and follow the instructions in this user manual before installing, operating or servicing this product.

The manufacturer will not accept liability for any resulting damages caused by the non-observance of this manual.

After unpacking, check the contents of the box. If any parts are missing or damaged, contact your Highlite International dealer.

Your shipment includes:

- Showtec AirDrive 2.4 Pocket, 5-pin XLR
- Antenna
- AC power adapter with 4 interchangeable AC plugs (Europe, UK, US/JP, AUS/NZ)
- User manual

Figure 1

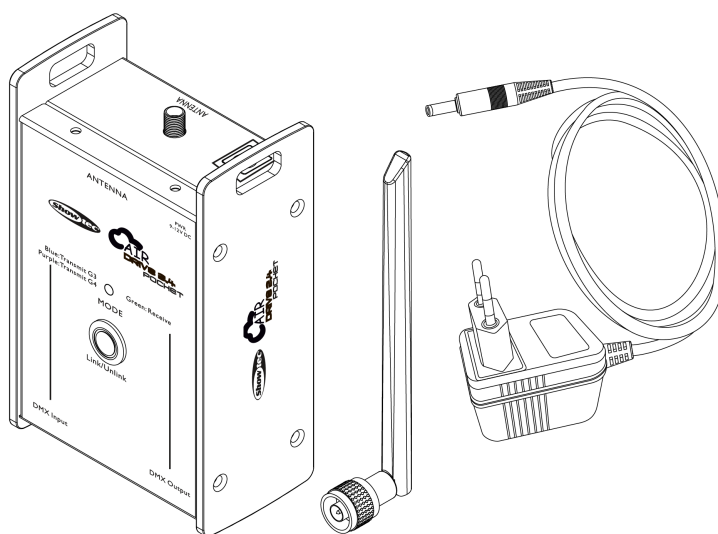

1.2. Intended Use

This device is intended for professional use as a DMX-512 transceiver and booster. It can be installed only indoors. This device is not suitable for households.

Any other use, not mentioned under intended use, is regarded as non-intended and incorrect use.

1.3. Text Conventions

Throughout the user manual the following text conventions are used:

- Buttons: All buttons are in bold lettering, for example "Press the **UP/DOWN** buttons"
- References: References to parts of the device are in bold lettering, for example: "turn the **adjustment handle (05)**". References to chapters are hyperlinked
- 0–255: Defines a range of values
- Notes: **Note:** (in bold lettering) is followed by useful information or tips

1.4. Symbols and Signal Words

Safety notes and warnings are indicated throughout the user manual by safety signs.

Always follow the instructions provided in this user manual.

**DANGER**

Indicates an imminently hazardous situation which, if not avoided, will result in death or serious injury.

**WARNING**

Indicates a potentially hazardous situation which, if not avoided, could result in death or serious injury.

**CAUTION**

Indicates a potentially hazardous situation, which, if not avoided, may result in minor or moderate injury.

**Attention**

Indicates important information for the correct operation and use of the product.

**Important**

Read and observe the instructions in this document.



Provides important information about the disposal of this product.

1.5. Symbols on the Information Label

This product is provided with an information label. The information label is located on the back side of the device.

The information label contains the following symbols:



This device shall not be treated as household waste.



Read and follow the instructions in the user manual before installing, operating or servicing the device.



This device falls under IEC protection class III.

2. Safety



Important
Read and follow the instructions in this user manual before installing, operating or servicing this product.

The manufacturer will not accept liability for any resulting damages caused by the non-observance of this manual.

2.1. Warnings and Safety Instructions



DANGER
Danger for children

For adult use only. The device must be installed beyond the reach of children.

- Do not leave any parts of the packaging (plastic bags, polystyrene foam, nails, etc.) within the reach of children. Packaging material is a potential source of danger for children.



Attention
Power supply

Before connecting the AC power adapter to the power supply, make sure that the current, voltage and frequency match the input voltage, current and frequency specified on the information label on the AC power adapter.



Attention
General safety

- Do not shake the device. Avoid brute force when installing or operating the device.
- If the device is exposed to extreme temperature variations (e.g. after transportation), do not switch it on immediately. Let the device reach room temperature before switching it on, otherwise it may be damaged by the formed condensation.



Attention
For professional use only
This device must be used only for the purposes it is designed for.

This device is designed to be used as a streaming pre-amplifier. Any incorrect use may lead to hazardous situations and result in injuries and material damage.

- This device is not suitable for households.
- This device does not contain user-serviceable parts. Unauthorized modifications to the device will render the warranty void. Such modifications may result in injuries and material damage.



Attention
Before each use, examine the device visually for any defects.

Make sure that:

- All screws used for installing the device or parts of the device are tightly fastened and are not corroded.
- There are no deformations on housings, fixings and installation points.

- The power cables are not damaged and do not show any material fatigue.

**Attention****Do not expose the device to conditions that exceed the rated IP class conditions.**

This device is IP20 rated. IP (Ingress Protection) 20 class provides protection against solid objects greater than 12 mm, such as fingers, and no protection against harmful ingress of water.

2.2. Requirements for the User

This product may be used by ordinary persons. Maintenance may be carried out by ordinary persons. Installation and service shall be carried out only by instructed or skilled persons. Contact your Highlite International dealer for more information.

Instructed persons have been instructed and trained by a skilled person, or are supervised by a skilled person, for specific tasks and work activities associated with the installation, service and maintenance of this product, so that they can identify risks and take precautions to avoid them.

Skilled persons have training or experience, which enables them to recognize risks and avoid hazards associated with the installation, service and maintenance of this product.

Ordinary persons are all persons other than instructed persons and skilled persons. Ordinary persons include not only users of the product but also any other persons that may have access to the device or who may be in the vicinity of the device.

3. Description of the Device

The Showtec AirDrive 2.4 Pocket, 5-pin XLR is a compact DMX-512 transceiver that can be switched between transmitter and receiver functionality. In transmitter mode, the device can transmit in G3 or G4 mode. In receiver mode, the device can receive in G3, G4 and G4S mode. A functional setup requires 1 unit set up as a transmitter and a minimum of 1 unit set up as a receiver.

The AirDrive 2.4 Pocket, 5-pin XLR has 5-pin DMX XLR connectors.

The AirDrive 2.4 Pocket, 5-pin XLR is compatible with the Showtec AirDrive 2.4 IP.

3.1. Top View

Figure 2

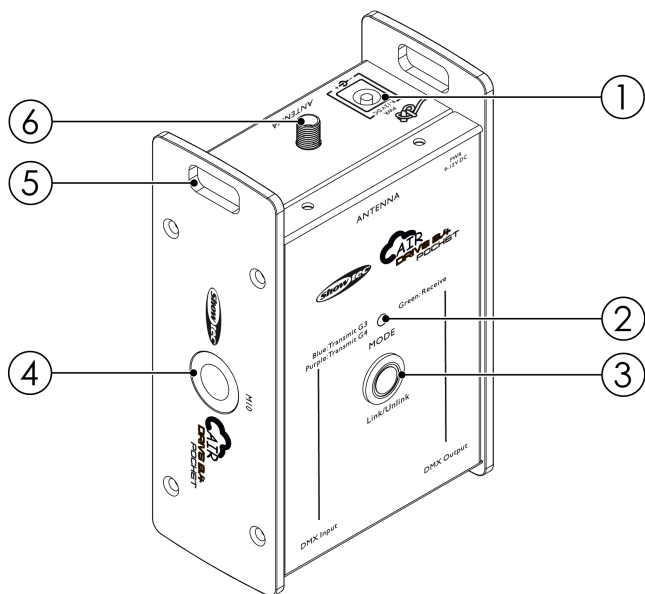

- 01) Low voltage DC connector
- 02) Mode LED indicator
- 03) Mode button
- 04) Mounting opening (M10)
- 05) 2x safety eye
- 06) Antenna connector

The **mode LED indicator (02)** lights up in different colors to indicate the status of the device.

LED color	Device status
White	Device in receiver mode, receiver disconnected
Green (continuous)	Receiver connected, DMX present
Green (slow flashing)	Receiver connected, no DMX present
Green (fast flashing)	Linking to transmitter
Red (continuous)	Deleting connection
Red (fast flashing)	Connection from transmitter is lost
Blue (continuous)	Device in transmitter G3 mode (2,4 GHz), DMX present
Blue (slow flashing)	Device in transmitter G3 mode (2,4 GHz), no DMX present
Blue (fast flashing)	Disconnecting receivers
Purple (continuous)	Device in transmitter G4 mode (2,4 GHz), DMX present
Purple (slow flashing)	Device in transmitter G4 mode (2,4 GHz), no DMX present
Purple (fast flashing)	Disconnecting receivers

3.2. Bottom View

Figure 3

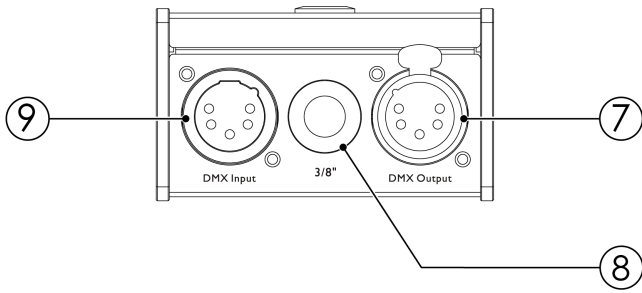

- 07) 5-pin DMX XLR connector OUT
- 08) Mounting opening (3/8")
- 09) 5-pin DMX XLR connector IN

3.3. Product Specifications

Model:	AirDrive 2.4 Pocket, 5-pin XLR
--------	--------------------------------

Control and programming:

DMX channels	512
Protocols	DMX
Operational modes	Transceiver

Electrical specifications and connections:

Power supply	9–12 V DC
Power consumption	6 W
Power connector in	Low voltage DC plug
DMX connector in	XLR 5P
DMX connector out	XLR 5P

Mechanical specifications:

Length	125 mm
Width	78 mm
Depth	44 mm
Weight	0,38 kg
IP rating	IP20 (indoor use only)
Housing	Metal
Color	Black

Rigging:

Mounting options	Clamp / stand
------------------	---------------

Thermal specifications:

Maximum ambient temperature	40 °C
Minimum ambient temperature	-10 °C
Minimum operating temperature	-10 °C

Wireless specifications:

Wireless mode	G3 / G4s / CRMX
Reaction time	5 ms
Antenna boost	2 dBi
Antenna type	Omni
Antenna radiation	360 x 180°

Power adapter:

Adapter type	AC-DC adapter
Input voltage	100–240 V AC, 50/60 Hz
Output voltage DC	12 V DC
Output current DC	1500 mA

3.4. Dimensions

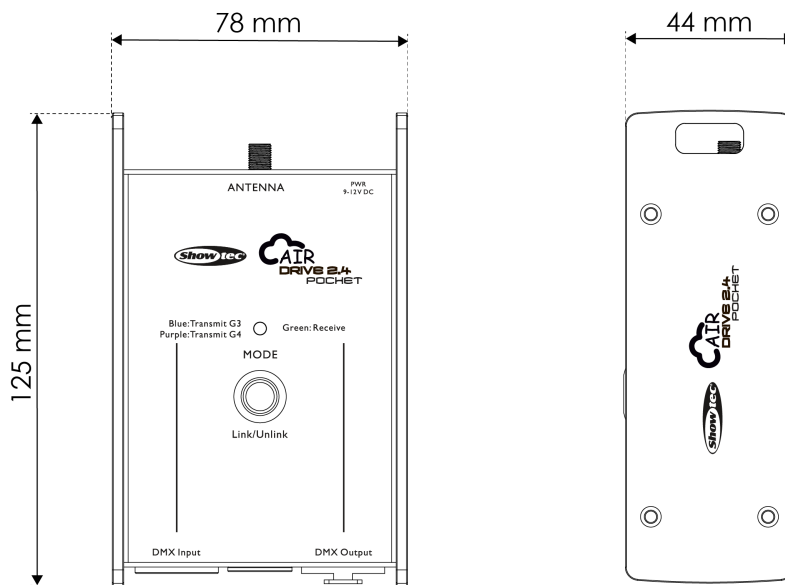
Figure 4

3.5. Optional Accessories

You can additionally purchase antennas which can enhance the connectivity range. The following products are available:

- [50117](#) Outdoor Mini Antenna 2,4 GHz, 2 dBi
- [50118](#) Indoor Omni Antenna 2,4 GHz, 3 dBi
- [50119](#) Indoor Omni Antenna 2,4 GHz, 6 dBi
- [50120](#) Outdoor Omni Antenna 2,4 GHz, 8 dBi

Contact your Highlite International dealer for more information.

4. Installation

4.1. Safety Instructions for Installation

**WARNING**

Incorrect installation can cause serious injuries and damage of property.

If trussing systems are used, installation must be carried out only by instructed or skilled persons.

Follow all applicable European, national and local safety regulations concerning rigging and trussing.

4.2. Personal Protective Equipment

During installation, deinstallation and rigging wear personal protective equipment in compliance with the national and site-specific regulations.

4.3. Installation Site Requirements

- The device can be used only indoors.
- The maximum ambient temperature $t_a = 40\text{ °C}$ must never be exceeded.
- The relative humidity must not exceed 50 % with an ambient temperature of 40 °C.

4.4. Mounting Options

The device can be mounted on a microphone stand or to a truss or other rigging structure using a clamp. Make sure that all loads are within the pre-determined limits of the supporting structure.



CAUTION

Restrict the access under the work area during rigging/derigging.

4.4.1. Mounting on a Microphone Stand

To mount the device on a microphone stand, follow the steps below:

- 01) Place the microphone stand on a level stable surface.
- 02) Fully extend the legs of the speaker stand.
- 03) Install the device on the microphone stand with the **mounting opening (3/8") (Ø8)**.

Figure 5

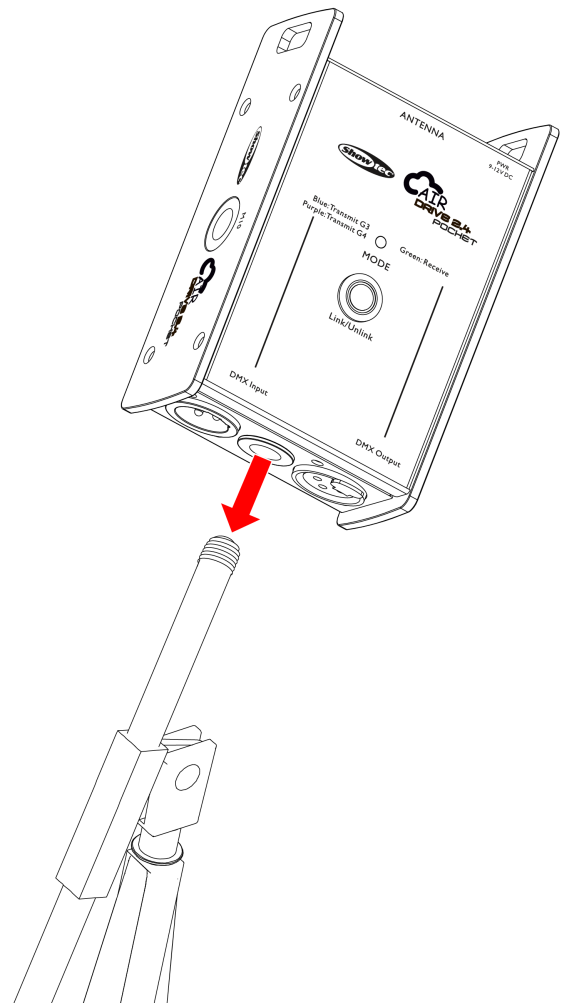

4.4.2. Mounting with a Clamp

Figure 6

To mount the device with a clamp, follow the steps below:

- 01) Install the clamp to the **mounting opening (M10) (04)**. Make sure that you use a clamp suitable for attaching the device to a truss.
- 02) Attach the device to the supporting structure. Make sure that the device cannot move freely.
- 03) Secure the device with a secondary suspension, for example a safety cable. Make sure that the secondary suspension can hold 10 times the weight of the device. If possible, the secondary suspension should be attached to a supporting structure independent of the primary suspension. Put the safety cable through the **safety eye (05)**.

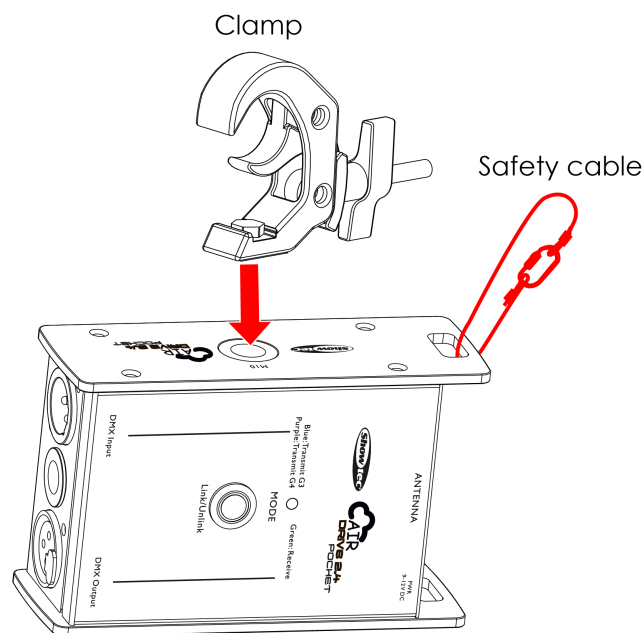

4.5. Installing the Antenna

The device is delivered with 1 antenna. Other antennas are optionally available (see [3.5. Optional Accessories](#) on page 10).

To install the antenna, follow the steps below:

- 01) Screw the antenna onto the **antenna connector (06)**.
- 02) Swivel the antenna into the upright position.

Note:

For a good reception, it is important that all antennas point in the same direction, upwards or sideways.

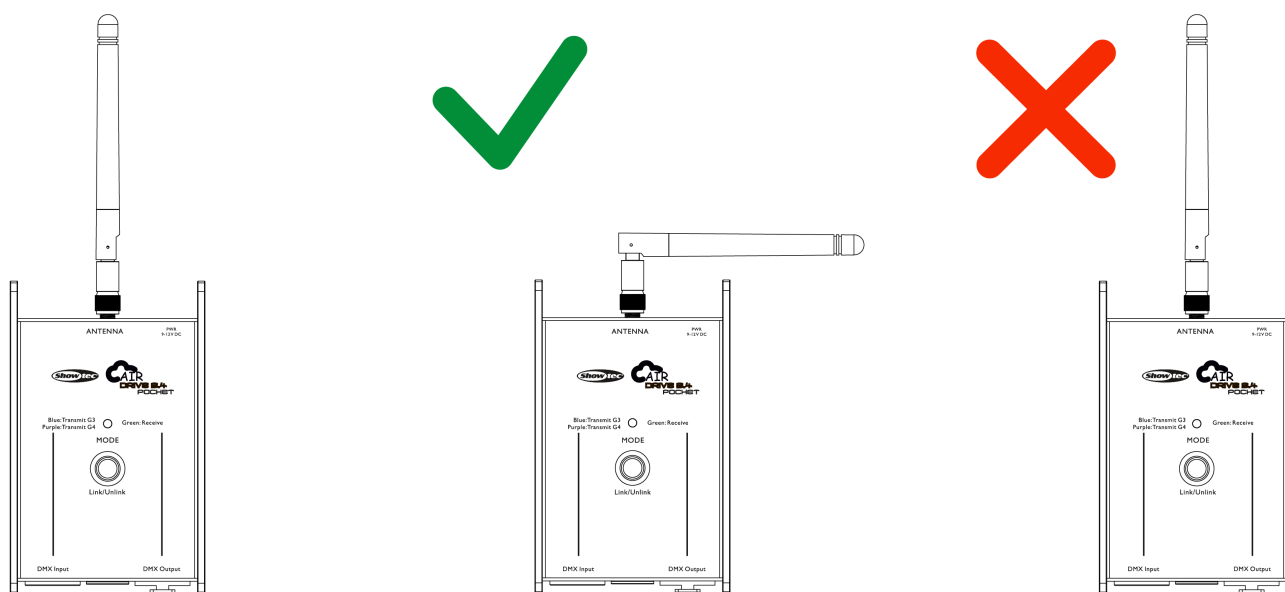
Figure 7

4.6. Line of Sight

There are limitations to how wireless waves transmit through air. Physical barriers like glass or walls limit the transmission range. It is important to always have a clear line of sight between transmitters and receivers.

Figure 8

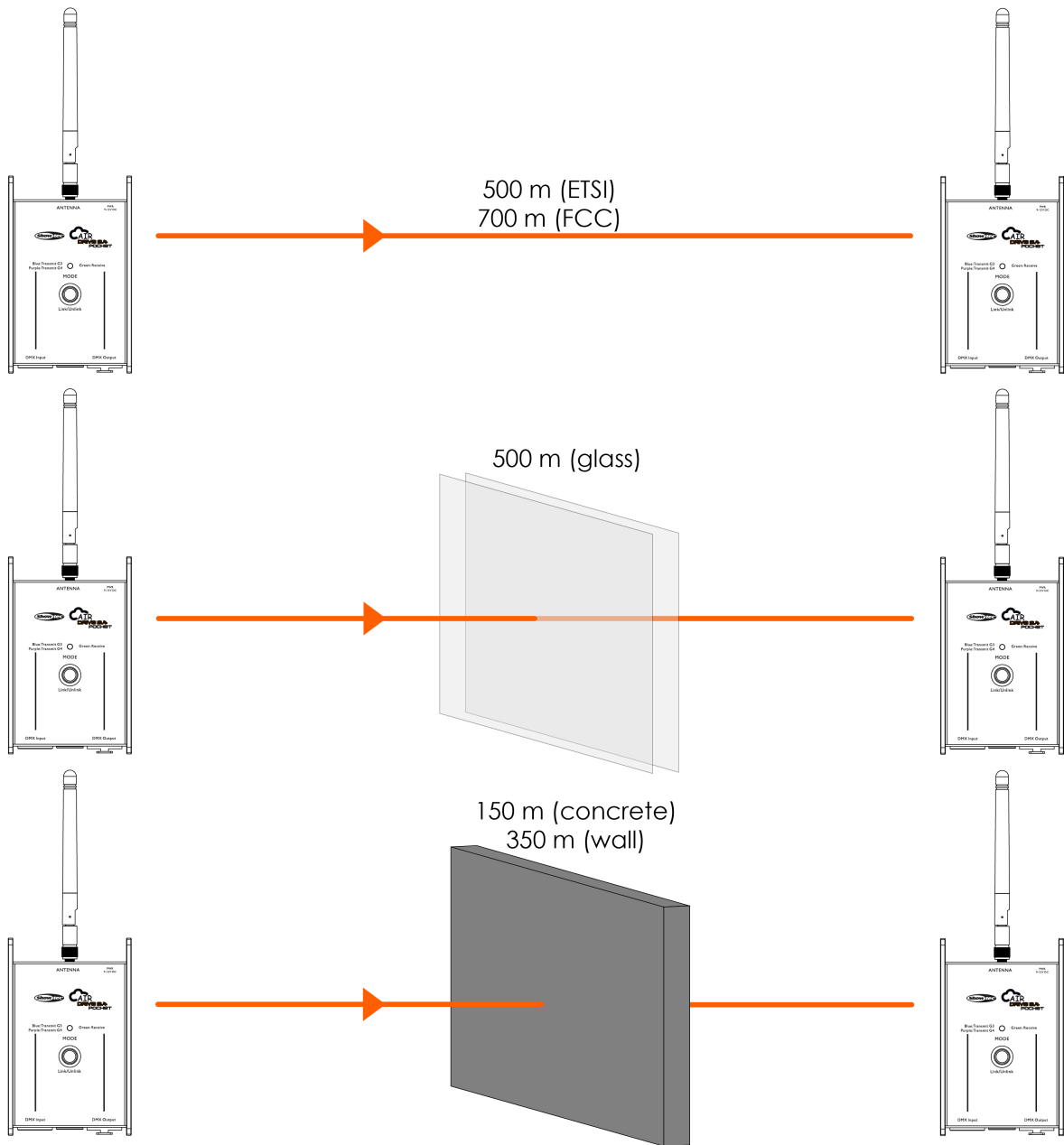

4.7. Connecting to Power Supply

**Attention**

Incorrect handling of the AC power adapter may result in hazardous situations.

This device shall be used with an AC power adapter (not included). Incorrect handling of the AC power adapter may result in hazardous situations.

- Make sure that the current, voltage and frequency match the input voltage, current and frequency specified on the information label on the AC power adapter.
- Connect the device to the socket-outlet with the AC power adapter.
- Make sure that the socket-outlet is easily accessible.
- Disconnect the AC power adapter from the socket-outlet when the device is not in use.

5. Setup and Operation

5.1. Warnings and Precautions



Attention

Connect all data cables before supplying power.

Disconnect power supply before connecting or disconnecting data cables.

5.2. Setup Example

The AirDrive 2.4 Pocket, 5-pin XLR can be used in various setups. At least 2 devices are required: 1 to be used as a transmitter and 1 to be used as a receiver.

Figure 9

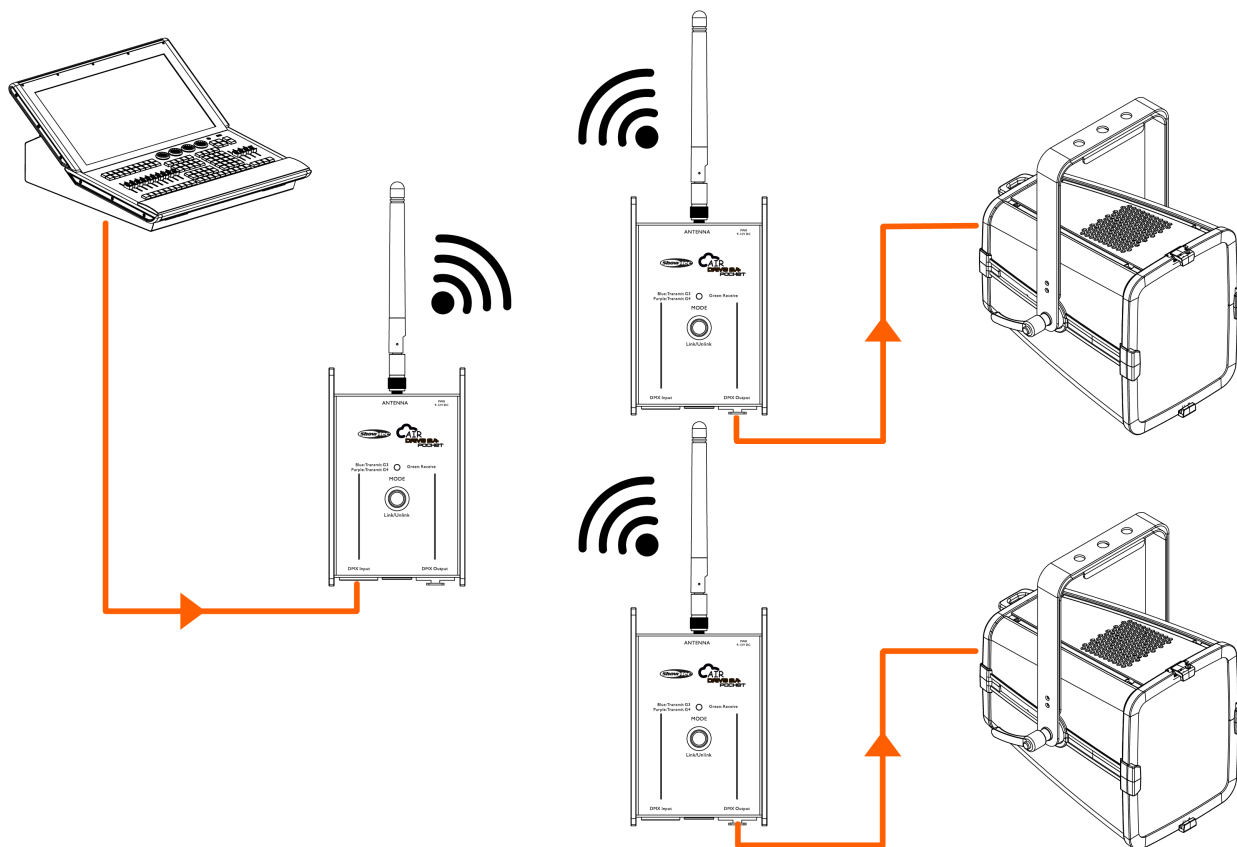

To wirelessly connect 1 or more devices, follow the steps below:

- 01) Set up an AirDrive 2.4 Pocket, 5-pin XLR as a transmitter. (see [5.4. Change the Transmitter/Receiver Mode](#) on page 18)
- 02) Connect a controller device to the **DMX XLR connector IN (07)** of the transmitter.
- 03) Set up 1 or more devices as a receiver.
- 04) Set the receiver devices to the same wireless group as the transmitter device.
- 05) Connect the **DMX XLR connector OUT (09)** of the receivers to output devices.

The signal from the transmitter device is now sent to the receiver devices.

5.3. Setup as Signal Booster

The AirDrive 2.4 Pocket, 5-pin XLR can be used as a signal booster to boost the signal across larger distances.

Figure 10

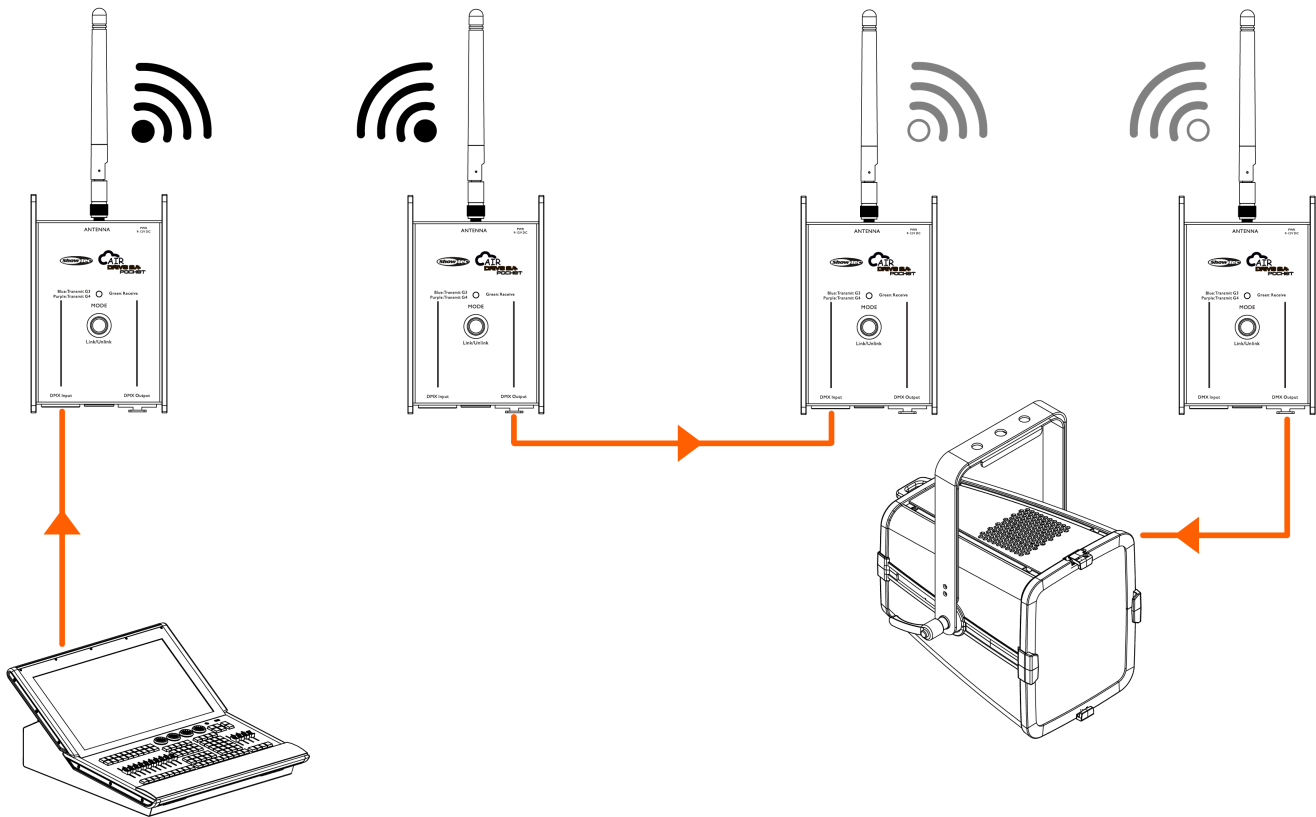

To use an AirDrive 2.4 Pocket, 5-pin XLR as a signal booster, follow the steps below:

- 01) Set up a 1st group of devices with transmitters and receivers. (see [5.2. Setup Example](#) on page 16)
- 02) Set up a new device as a transmitter. (see [5.4. Change the Transmitter/Receiver Mode](#) on page 18)
- 03) Set the device to a different wireless group.
- 04) Connect the **DMX XLR connector OUT (07)** of a receiver device in the 1st wireless group to the **DMX XLR connector IN (09)** of the new transmitter device.
- 05) Set up 1 or more more devices as receivers and connect them to the 2nd wireless group.
- 06) Connect the **DMX XLR connector OUT (07)** of the receivers in the 2nd group to output devices.

The signal from the first group of devices is now repeated by the 2nd transmitter to the remaining receivers.

5.4. Change the Transmitter/Receiver Mode

The AirDrive 2.4 Pocket, 5-pin XLR has a set-up mode and a use mode. In the set-up mode, the transmission protocol of the device can be changed. In the use mode, the connection between devices can be set up.

To change the transmission protocol, follow the steps below:

- 01) Press and hold the **mode button (03)** until the **mode LED indicator (02)** lights up white.
- 02) Release the **mode button (03)** when the **mode LED indicator (02)** lights up white. The AirDrive 2.4 Pocket, 5-pin XLR is now in set-up mode.
- 03) Press the **mode button (03)** to cycle through the 3 transmission protocols:
 - Green: W-DMX Receive mode
 - Blue: W-DMX G3 Transmit mode
 - Purple: W-DMX G4 Transmit mode
- 04) When you have selected the right mode, press and hold the **mode button (03)** until the **mode LED indicator (02)** lights up white. The device is now in use mode.

Note:

The AirDrive 2.4 Pocket, 5-pin XLR remembers the selection even after shutting down the device or disconnecting the power supply.

5.5. Connecting and Disconnecting Multiple Devices

In the G3 or G4 Transmit mode, the AirDrive 2.4 Pocket, 5-pin XLR that is used as a transmitter, can be connected to all active receivers within range that are not yet connected:

Press the **mode button (03)** on the transmitter to connect it to all powered receivers that are within range. The **mode LED indicator (02)** starts flashing fast to indicate the connecting procedure. The **mode LED indicator (02)** stops flashing once the devices are connected.

To disconnect all receivers that are connected to a transmitter device:

Press and hold the **mode button (03)** on the transmitter until the **mode LED indicator (02)** flashes red (at least 3 seconds). All active receivers within range are disconnected.

5.6. Restore Factory Settings

To restore the device to the factory settings, follow the steps below:

- 01) Press and hold the **mode button (03)** until the **mode LED indicator (02)** flashes blue.
- 02) When the **mode LED indicator (02)** flashes blue, release the **mode button (03)**. The **mode LED indicator (02)** flashes red, green and blue and then lights up red to confirm that the factory settings are restored.

5.7. DMX Connection

5.7.1. DMX-512 Protocol

The AirDrive 2.4 Pocket, 5-pin XLR has 5-pin DMX signal IN and OUT connectors.

The pin assignment is as follows: pin 1 (ground), pin 2 (-), pin 3 (+).

Devices on a serial data link must be daisy-chained in a single line. The number of devices that you can control on one data link is limited by the combined number of the DMX channels of the connected devices and the 512 channels available in one DMX universe.

To comply with the TIA-485 standard, no more than 32 devices should be connected on one data link. In order to connect more than 32 devices on one data link, you must use a DMX optically isolated splitter/booster, otherwise this may result in deterioration of the DMX signal.

Note:

- Maximum recommended DMX data link distance: 300 m
- Maximum recommended number of devices on a DMX data link: 32 devices

5.7.2. DMX Cables

Shielded twisted-pair cables with 5-pin XLR connectors must be used for reliable DMX connection. You can purchase DMX cables directly from your Highlite International dealer or make your own cables.

If you use XLR audio cables for DMX data transmission, this may lead to signal degradation and unreliable operation of the DMX network.

When you make your own DMX cables, make sure that you connect the pins and wires correctly as shown in the figure below.

Figure 11

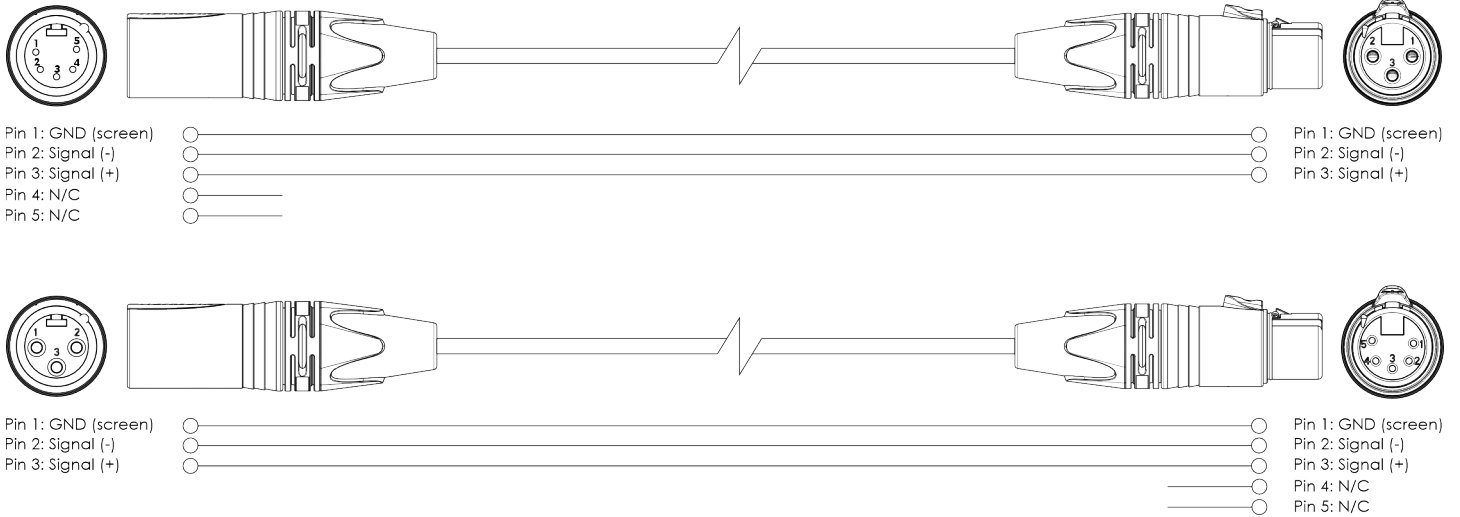

6. Troubleshooting

This troubleshooting guide contains solutions to problems which can be carried out by an ordinary person. The device does not contain user-serviceable parts.

Unauthorized modifications to the device will render the warranty void. Such modifications may result in injuries and material damage.

Refer servicing to instructed or skilled persons. Contact your Highlite International dealer in case the solution is not described in the table.

Problem	Probable cause(s)	Solution
The device does not function at all	No power to the device	<ul style="list-style-type: none"> Make sure that the device is connected to power supply and the cables are plugged in
The device responds erratically	The factory settings of the device are changed	<ul style="list-style-type: none"> Reset the parameters of the device to the default factory settings (see 5.6. Restore Factory Settings on page 18)
The device does not respond to DMX control	The controller is not connected	<ul style="list-style-type: none"> Connect the controller
	The signal is reversed. The 5-pin DMX OUT of the controller does not match the DMX IN of the device	<ul style="list-style-type: none"> Install a phase-reversing cable between the controller and the device
	The controller is defective	<ul style="list-style-type: none"> Try using another controller
The device responds erratically to DMX control	The transmitter/receiver is not set up correctly	<ul style="list-style-type: none"> Make sure that all devices are set to the correct mode (see 5.4. Change the Transmitter/Receiver Mode on page 18)
	Connections are defective	<ul style="list-style-type: none"> Examine connections and cables. Correct defective connections. Repair or replace damaged cables
	The data link is not terminated with a 120 Ω termination plug	<ul style="list-style-type: none"> Insert a termination plug in the DMX OUT connector of the last device on the link
	Incorrect addressing	<ul style="list-style-type: none"> Make sure that the address settings are correct
The connected fixtures do not function	In case of a setup with multiple devices, one of the devices is defective and disturbs data transmission on the link	<ul style="list-style-type: none"> To find out the defective device, bypass 1 device at a time until normal operation is restored
	The fixtures are incompatible	<ul style="list-style-type: none"> Disconnect the fixtures and check their compatibility
The device does not respond to DMX control	The fixtures are defective	<ul style="list-style-type: none"> Try using different fixtures
	The controller is not connected	<ul style="list-style-type: none"> Connect the controller
The device does not respond to DMX control	The signal is reversed. The 5-pin DMX OUT of the controller does not match the DMX IN of the device	<ul style="list-style-type: none"> Install a phase-reversing cable between the controller and the device

7. Maintenance

7.1. Preventive Maintenance



Attention
Before use, examine the device visually for any defects.

Make sure that:

- All screws used for installing the device or parts of the device are tightly fastened and are not corroded.
- The safety devices are not damaged.
- There are no deformations on housings, fixings and installation points.
- The power cables are not damaged and do not show any material fatigue.

7.1.1. Basic Cleaning Instructions

To clean the device, follow the steps below:

- 01) Disconnect the device from the electrical power supply.
- 02) Allow the device to cool down for at least 5 minutes.
- 03) Clean the device with a soft, lint-free cloth.



Attention

- Do not immerse the device in liquid.
- Do not use alcohol or solvents.

7.2. Corrective Maintenance

The device does not contain user-serviceable parts. Do not open the device and do not modify the device.

Refer repairs and servicing to instructed or skilled persons. Contact your Highlite International dealer for more information.

8. Deinstallation, Transportation and Storage

8.1. Instructions for Deinstallation



WARNING

Incorrect deinstallation can cause serious injuries and damage of property.

- Let the device cool down before dismantling.
- Disconnect power supply before deinstallation.
- Always observe the national and site-specific regulations during deinstallation and derigging of the device.
- Wear personal protective equipment in compliance with the national and site-specific regulations.

8.2. Instructions for Transportation

- Use the original packaging to transport the device, if possible.
- Always observe the handling instructions printed on the outer carton box, for example: "Handle with care", "This side up", "Fragile".

8.3. Storage

- Clean the device before storing (see [7.1.1. Basic Cleaning Instructions](#) on page 21).
- Store the device in the original packaging, if possible.

9. Disposal

Correct disposal of this product

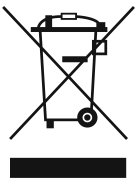

Waste Electrical and Electronic Equipment

This symbol on the product, its packaging or documents indicates that the product shall not be treated as household waste. Dispose of this product by handing it to the respective collection point for recycling of electrical and electronic equipment. This is to avoid environmental damage or personal injury due to uncontrolled waste disposal. For more detailed information about recycling of this product contact the local authorities or the authorized dealer.

10. Approval



Hereby, Highlite International declares that the device AirDrive 2.4 Pocket, 5-pin XLR, product code 50260, is in compliance with Directive 2014/53/EU (RED – Radio Equipment Directive).

The full text of the EU declaration of conformity is available on the respective product page on the website of Highlite International (www.highlite.com).

