

DANCE FX BY AYRA

Hypnose USB-Powered RGB LED Light Effect



User Manual

The information included in this user manual is subject to change at any time and without notification:

Version: 1.0 Date & Author Initials: 01-02-2024 RV

Revision Date & Author Initials: -

Introduction

Thank you for purchasing the Ayra DanceFX Hypnose light effect. Ayra's DanceFX USB-powered light effects have been designed to project colourful and dynamic beams of light and enhance the atmosphere of any party. This manual provides you with all the information you need to know before using these products.

Before unpacking the box, we recommend reading this user manual thoroughly to ensure that you are familiar with all of the features and functions that this device has to offer. When unpacking the box, please make sure that all of the components and accessories listed below have been included. If the device does not function as it should, unplug any connected cables before contacting your local retailer for further advice.

Box contents:

- Ayra DanceFX Hypnose RGB light effect
- Power cable (USB-A to 5.5 mm × 2.1 mm centre-positive barrel plug)

Inspection of the Device & Included Accessories

If the device or any of the included accessories have been damaged or rendered defective in transit, please contact your local retailer for further advice.

Please note: The products seen in the images included in this manual may differ slightly from the actual products.

DANCE FX
BY AYRA

Contact:

Ayra Professional Lighting Products
Verrijn Stuartweg 18
4462 GE Goes
The Netherlands

This is a correspondence address only. Please do not send any physical products to this address. If you need to send a product for repairs or for a refund, please contact your retailer for an RMA request (Return Merchandise Authorisation)

The information included in this user manual is subject to change at any time and without notification:

Version: 1.0 Date & Author Initials: 01-02-2024 RV

Revision Date & Author Initials: -

Safety Instructions



WARNING!



Keep this device away from moisture, water and rain to prevent any danger of electric shocks!



WARNING!



This device runs on a specific voltage and must only be connected to a USB power supply with enough capacity (5V DC/1A). If this device is connected to a power source with a different voltage than specified, this may cause permanent damage or lead to harmful effects including fire hazards or electric shocks.



WARNING!



Always take care when operating this device. Avoid touching any external or internal live wiring as they may cause harmful electric shocks!

Every person involved with the installation, operation and maintenance of this device must:

- Be qualified.
- Be skilled.
- Have read the instructions included in this user manual.
- Be sure that neither the device nor the included accessories are damaged. Should the device or the included accessories be damaged, please contact your retailer for further advice.
- Ensure that the device is in good working condition and is safe to operate. Please follow the advice and instructions as they are described in this user manual.

Any damage caused by incorrect use and/or user modifications are not covered by the warranty.

This device does not contain any parts that can be repaired or replaced by the user. Should maintenance or repairs be necessary, they must be carried out by a qualified technician.

The information included in this user manual is subject to change at any time and without notification:

Version: 1.0 Date & Author Initials: 01-02-2024 RV

Revision Date & Author Initials: -

The light source of the device cannot be replaced. In the event that the light source fails, the entire device will need to be replaced.

Important Health & Safety Information:

- Do not remove any labels or stickers from this device.
- Do not leave any cables lying around where they are in danger of causing a tripping hazard.
- The housing of this device must not be opened and any hardware or software that may be present must not be modified.
- For optimal performance, any inputs should not be fed with a signal higher than necessary.
- The device must only be used indoors; contact with water, rain and moisture must always be avoided. Do not place any objects containing liquid on top of the device.
- Never expose the device to flames or heat sources; do not place it near flammable fluids, gases or objects.
- Disconnect this device from a power source if it is not being used for a long period of time, if maintenance is required, or if it needs to be cleaned.
- Do not pull or tug on any cables to remove plugs as this may cause damage.
- Do not use any cables other than those specified in this manual. Do not use defective cables. Please contact your retailer if the included or specified cables do not function properly with this device.
- Only ever power this device via the included USB power supply or any other compatible USB power supply with a high-enough capacity (5 V DC, 1 A).
- In the event that the device is exposed to extreme temperature changes (e.g. transported from a cold outdoor environment into a warm indoor environment), it must not be turned on until it has reached room temperature. This is necessary to prevent moisture (condensation) from forming inside the device, which may cause electric shocks.

Use & Operation Guidelines:

- This device is intended for domestic use by consumers. The device is designed to create atmospheric lighting effects on festive occasions where the device is used for no more than several hours as part of fixed setup. The device is not designed for frequent transport and professional use.
- This device is not suitable for use by children and must always be operated by an adult.
- This device is designed to serve as decorative lighting for entertainment purposes and is not suitable for normal household lighting.
- This device can only be used in appropriate environments where no damage to the device can occur. Do not use the device in moist or dusty environments such as:
 - indoor swimming pools where chlorine is used
 - beaches or any location where sand and/or salt is present
 - outdoors
 - In indoor spaces where intense heat sources are present, or where it can reach temperature levels that would be considered uncomfortable for a human being.
- Avoid impact and collisions during use and transport. Do not move or transport the device while it is in use. Avoid using excessive force when installing and operating the device.
- Any user must become familiar with the functions of this device before using it.
- The user must be able to completely disconnect the power supply to the device in the event of an emergency. Therefore, the power connection of the device must always be

The information included in this user manual is subject to change at any time and without notification:

Version: 1.0 Date & Author Initials: 01-02-2024 RV

Revision Date & Author Initials: -

accessible and operated via one of the following parts of the product:

- the USB power cable, which supplies the device with a maximum voltage of 5 V DC via the USB power port;
 - the USB power supply to which the device is connected via the included USB cable.
- If the device is not operated in the manner described in this user manual, damages or even injuries could occur. Ayra cannot be held responsible for any injuries or damages that occur as a result of improper use of this product.

Storage & Transport:

- This device is not designed for mobile use. Always transport the device in its original packaging or in a flight case with a foam-lined interior.
- This device has not been designed for continuous (24/7) use. Regularly switching the device off will not affect the expected lifespan of the device. Always switch off and unplug the device when it is not in use.
- When the device is not in use for long periods of time, always disconnect the device from the mains power and store it in a dust free environment.
- Do not expose the device to extreme temperature shifts.

Housing:







- Frequently inspect the housing of the device and always just before use. Avoid operating the device if any large dents or cracks are found in the housing, or if screws are missing. Do not use the device if the housing is not in good condition. Contact your local retailer or a qualified technician if you are unsure about the state of the device.
- Check the device and screws for any corrosion. If any corrosion is found, do not use the device. Contact your retailer or a qualified technician if the screws or housing show any signs of corrosion.
- Ensure that every power and signal socket is securely fitted. Do not use the device if any of the sockets are not secure.
- Avoid the build up of any dust and dirt. Clean the device once a month by disconnecting it from the power supply and wiping it down with a dry or slightly moist cloth. If the device is used frequently, the device should also be cleaned more frequently.

The information included in this user manual is subject to change at any time and without notification:

Version: 1.0 Date & Author Initials: 01-02-2024 RV

Revision Date & Author Initials: -

Symbol explanation:

| | |
|---|---|
|  | <p>WEEE: Ensure that this device is disposed of properly. This product falls under the WEEE (Waste Electrical and Electronic Equipment) directive. The requirements of this directive apply to all manufacturers and producers of electronic devices in the EU. Do not throw this product away with normal refuse. Please contact your local authority for more information about how to recycle and dispose of these products in your region. By recycling this product in the proper manner, we can work together to ensure that we can continue to enjoy these kinds of products and still protect the environment as much as possible.</p> |
|  | <p>CE: The CE logo indicates that this product meets the European norms and requirements to which it must legally conform.</p> |
|  | <p>UKCA: The UKCA mark indicates that this product conforms to the directives and standards that this product is legally required to comply with in the United Kingdom.</p> |
|  | <p>For indoor use only: This product was designed for indoor use only.</p> |
|  | <p>Class III: Lighting fixture where protection against electric shock is based on Safety Extra-Low Voltage (SELV) or Protective Extra-Low Voltage (PELV), meaning the device does not generate higher voltages than SELV or PELV.</p> |
|  | <p>DC power cable plug polarity: Centre-positive (CP). The inner contact (centre) is +. The outer contact is -.</p> |



FR

Cet appareil, ses accessoires et cordons se recyclent

À DÉPOSER EN MAGASIN

À DÉPOSER EN DÉCHÈTERIE

OU

Points de collecte sur www.quefairedemesdechets.fr
Privilégiez la réparation ou le don de votre appareil !



The information included in this user manual is subject to change at any time and without notification:

Version: 1.0 Date & Author Initials: 01-02-2024 RV

Revision Date & Author Initials: -

Overview

1. Adjustable mounting bracket
2. LED light source with projection lens
3. Power input (DC barrel)

Power cable:

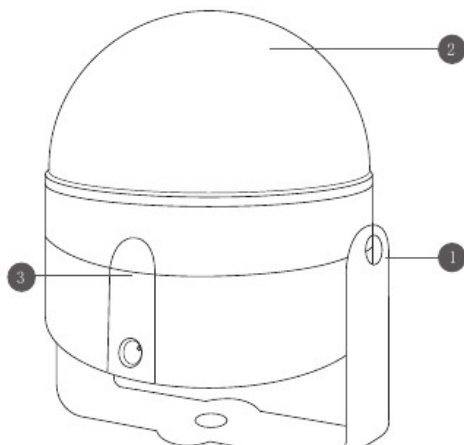

Operation

Ayra DanceFX USB-powered light effects are easy to use and are ideal for parties and other get-togethers. The various units can be set up in automatic or sound-to-light mode, or controlled using the included IR remote control.

To ensure that you get the best performance out of your DanceFX light effect, and to ensure that it is installed and operated safely, it is strongly recommended to read the following information in full.

Power Supply

This USB light effect must be powered by a stable USB power supply with a minimum capacity of 1 A/5 V DC. Most high-power USB sources will be compatible, including most phone/tablet chargers and USB powerbanks.

The unit can be connected to a compatible power supply using the included USB cable. As soon as it's properly connected to a USB power supply, the device will turn on and start playing the built-in program.

Setting Up The Unit

Ayra DanceFX light effects offer optimum performance when installed in an elevated position. This way, the light beams can travel further. If suspending the unit is not possible, it can also be placed on a tabletop or other flat surface. Bear in mind that none of the units are equipped with any stabilising feet, so tugging on the power cable can easily cause a unit to fall off the surface it's been placed on. However, it is possible to secure the device to a

The information included in this user manual is subject to change at any time and without notification:

Version: 1.0 Date & Author Initials: 01-02-2024 RV

Revision Date & Author Initials: -

surface using the integrated mounting bracket.

Suspended/Fixed Installation

All Ayra DanceFX units feature a mounting bracket for fixed installation.

The mounting bracket can be wall-mounted, ceiling-mounted or secured to a beam. Depending on the preferred mounting option, different mounting hardware may be required. As such, no mounting hardware is included as standard.

Repairs, Spare Parts and Accessories

The device has not been equipped with replaceable parts and can not be repaired by end users. If repair or maintenance is required, always seek the help of a qualified technician.

Cleaning and Maintenance

Avoid the build up of any dust and dirt. Clean the device once a month by disconnecting it from the power supply and wiping it down with a dry or slightly moist cloth.

Technical Specifications

- Super-compact LED light effect
- Equipped with a red, green and blue LED
- Rotating design for dynamic light shows
- Plug-and-play (automatic light show)
- Includes USB power cable (USB-A to 5.5 mm × 2.1 mm DC CP barrel plug)
- Compatible with all 5 V/1 A DC USB power supplies (none included)
- Can be powered using a USB powerbank, the built-in USB port of a laptop, computer or party speaker, and even USB car chargers
- Equipped with adjustable mounting bracket
- Max. power draw: 5 W
- Dimensions: 87 × 87 × 90 mm
- Packaged dimensions: 110 × 100 × 100 mm
- Weight: 0.1 kg

The information included in this user manual is subject to change at any time and without notification:

Version: 1.0 Date & Author Initials: 01-02-2024 RV

Revision Date & Author Initials: -