



DIGITAL PIANO

P - 2 2 5

P - 2 2 3

**Reference Manual**

## About the Manuals

---



### ● Owner's Manual (booklet supplied with the product package)

Explains how to use the basic functions of this instrument, as well as "Precautions" which should be read before using this instrument.

### ● Reference Manual (this manual)

Explains all functions of this instrument including advanced functions and MIDI-related functions.

#### General contents of the notes

 <b>WARNING</b>	Important information to avoid the possibility of serious injury or even death from electrical shock, short-circuiting, damages, fire or other hazards.
 <b>CAUTION</b>	Important information to avoid the possibility of physical injury to you or others, or damage to the instrument or other property.
<b>NOTICE</b>	Important information to avoid the possibility of malfunction or damage to the product, damage to data, or damage to other property.
 <b>NOTE</b>	Helpful information and tips.

### ● Quick Operation Guide



<https://manual.yamaha.com/mi/kb-ekb/p-225/qg/>

Shows in chart form the functions assigned to the keyboard. This can be printed out and placed it on a music rest for use as a quick reference for important operations.

### ● Smart Pianist User Guide

Explains how to set up and use a smart device with the dedicated Smart Pianist app (page 48) for controlling this instrument.

### ● Smart Device Connection Manual

Explains how to connect the instrument to smart devices, such as a smartphone, tablet, etc.

### ● Computer-related operations

Includes instructions on connecting the instrument to a computer, and other operations.

To obtain these manuals, access the Yamaha website below:

#### Yamaha Downloads

<https://download.yamaha.com/>

After selecting your country and clicking on "Manual Library," enter the model name, etc. to search for the desired files.

\* For a general overview of MIDI and how you can effectively use it, search for "MIDI Basics" (only in English, German, French and Spanish) on the website above.

### ■ About this manual

- The illustrations as shown in this manual are for instructional purposes only.
- Unless indicated otherwise, the illustrations as shown in this manual are based on the P-225 (in English).
- Windows is a registered trademark of Microsoft® Corporation in the United States and other countries.
- The Bluetooth word mark and logos are registered trademarks owned by Bluetooth SIG, Inc. and any use of such marks by Yamaha Corporation is under license.



- The company names and product names in this manual are the trademarks or registered trademarks of their respective companies.

# Contents

About the Manuals .....	2	Virtual Resonance Modeling Lite (VRM Lite) .....	34
<b>Panel Controls and Terminals</b>	<b>4</b>	Reverb .....	35
<b>Setting Up</b>	<b>7</b>	<b>Recording Your Performance</b>	<b>36</b>
Power Requirements.....	7	Recording .....	36
Turning the Power On/Off .....	7	Recording Independently to Two Parts.....	37
Auto Power Off Function .....	8	Deleting the entire User Song.....	38
Intelligent Acoustic Control (IAC) .....	9	Deleting a specific Part of the User Song .....	39
<b>Basic Operations</b>	<b>10</b>	Changing the Initial Settings of the Recorded Song .....	40
Operations by using both buttons and keys .....	10	<b>Connecting Other Equipment</b>	<b>41</b>
Backup Parameters and Initializing.....	11	Using Headphones .....	41
Confirming the firmware version of this instrument.....	12	Using the Included Footswitch or Separately Sold Pedal Unit .....	42
<b>Playing with Various Voices</b>	<b>13</b>	Connecting External Speakers .....	44
Selecting a Voice .....	13	Connecting to a Computer or Smart Device .....	46
Playing two different Voices with your left and right hands (Split) .....	15	Using Smart Device Apps.....	48
Layering Two Voices in Different Voice Groups (Dual) .....	17	Listening to Audio playback of the Bluetooth device on this Instrument .....	49
Playing Duo.....	18	<b>MIDI Functions</b>	<b>51</b>
Discovering the Voices with the Voice Demo Songs .....	20	MIDI Transmit/Receive Channel Selection .....	51
<b>Using the Metronome</b>	<b>21</b>	Local Control On/Off .....	52
<b>Playing Back Songs</b>	<b>23</b>	Program Change On/Off.....	53
Playing back a Song while Muting the Right or Left Part .....	25	Control Change On/Off .....	54
<b>Adding Accompaniment to Your Performance (Rhythm)</b>	<b>26</b>	Preset Voice List.....	55
<b>Useful Performance Settings</b>	<b>29</b>	Effect Type List.....	56
Sound Boost.....	29	MIDI Implementation Chart.....	57
Transpose .....	30	<b>Appendix</b>	
Tuning .....	31	<b>Troubleshooting</b>	<b>58</b>
Wall EQ .....	32	<b>Index</b>	<b>59</b>
Touch Sensitivity .....	33		

# Panel Controls and Terminals

## [⏻](Standby/On) switch, Power lamp (page 7)

For turning the power on or setting to standby.  
The lamp on the right side indicates the on/off status of the instrument.

## [VOLUME] slider (page 7)

For adjusting the volume of the entire sound.

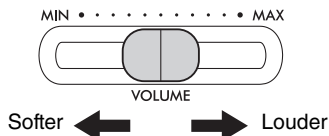

## [DEMO/SONG] button

(pages 20, 23)  
For playing the Demo Songs and preset Songs.

## [-][+] , [L][R] buttons

(pages 21, 24–26, 31, 37)

### Using as the [-][+] buttons

For adjusting the tempo (pages 21, 24, 26), selecting a Song during playback (page 24), or setting the tuning value (page 31), etc.

### Using as the [L][R] buttons

For selecting the Song part for playback (page 25) and recording (page 37).

## Front Panel

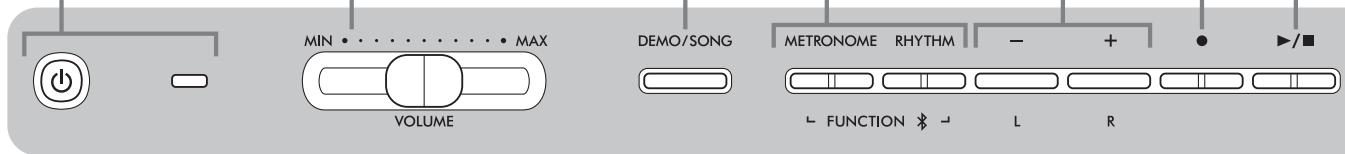

\* This panel illustration is of the P-225.

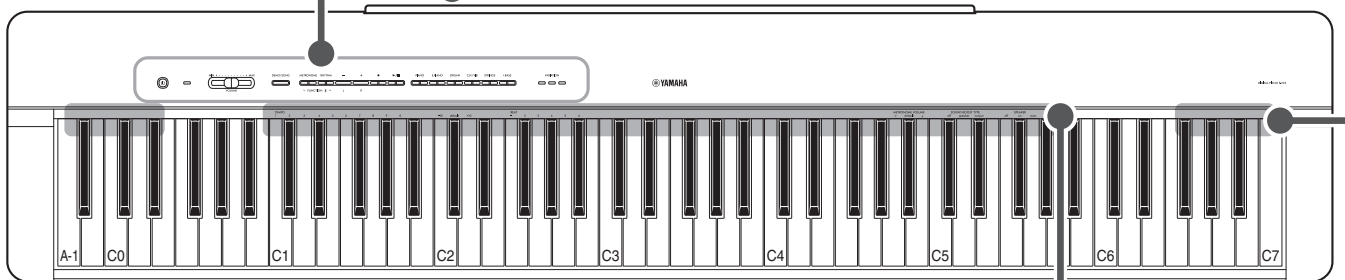

## [PHONES] jacks (page 41)

For connecting a set of standard headphones. You can connect two pairs of headphones. If you are using only one pair, insert the plug into either of these jacks.

### CAUTION

- Do not use the headphones for a long period of time at a high or uncomfortable volume level, since this can cause permanent hearing loss.

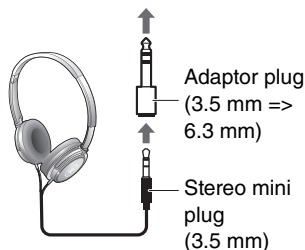
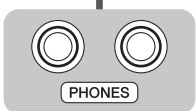

## Indications for key-based operations

(pages 10, 22, 23, 28–35)

### Operate by using both buttons and keys

These indications show that the corresponding keys control a certain function, which is operated by a combination of the panel buttons.

**[METRONOME] button** (page 21)

For starting or stopping the metronome.

**[RHYTHM] button** (page 26)

For starting or stopping the rhythm (drums and bass accompaniment).

**What is Rhythm?**

This instrument features dynamic Rhythm patterns, consisting of drums and bass accompaniment. Pressing the [RHYTHM] button starts the percussion part and playing the keyboard with your both hands starts bass accompaniment (page 26).

**Using as the [FUNCTION] buttons**

While simultaneously holding down the [METRONOME] and [RHYTHM] buttons, pressing the appropriate key lets you make various settings. Holding down the [METRONOME] and [RHYTHM] buttons for longer than three seconds starts pairing between this instrument and a Bluetooth-equipped device such as a smartphone (page 49).

\* Bluetooth function described above may not be available depending on the country in which you purchased the product (page 50).

**[●] (Record) button** (page 36)

For recording your keyboard performance.

**[▶/■](Play/Stop) button**

(pages 23, 36)

For playing back/stopping the recorded performance (User Song) or stopping preset Songs.

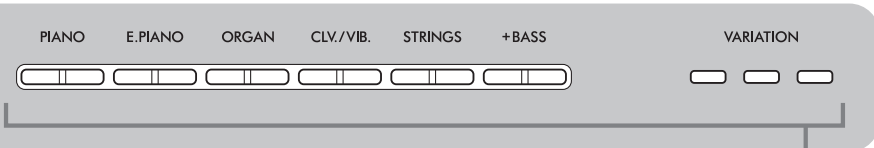

**Rear Panel**

Refer to page 6.

**Built-in speakers** (page 45)

You can set whether the sound of this instrument is always output from these speakers(on) or not(off), or mute the sound output only when headphones are connected (auto).

**Default Setting:** auto

**Voice buttons** (pages 13, 15, 17, 20)

**Selecting a Voice**

Press a desired Voice (group) button.

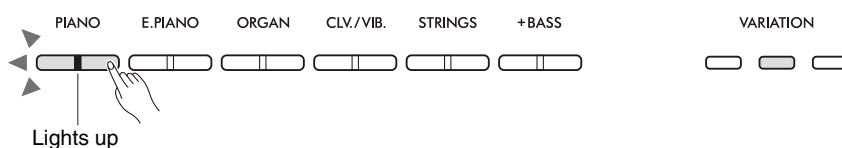

\* The illustration at left is of the P-225.

You can select from among four different Voices with a Voice button. Each press of the same button turns on/off the [VARIATION] lamp and selects one of four Voices in sequence. For details on the preset Voices, refer to the Voice List (Detailed) on page 13.

**CAUTION**

- Before connecting the instrument to other electronic components, turn off the power to all the components. Before turning the power on or off to all components, set all volume levels to minimum (0). Otherwise, electrical shock or damage to the components may result.

**AUX OUT [R][L/L+R] jacks**

(page 44)

For connecting external audio equipment such as powered speakers in order to play at higher volumes.

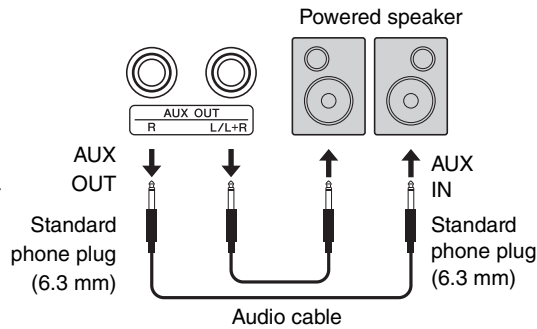

**DC IN jack** (page 7)

For connecting the included or specified AC adaptor (refer to the Specifications in the Owner's Manual).

**Rear Panel**

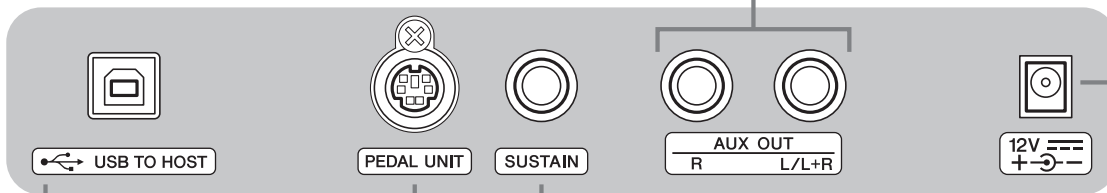

**[SUSTAIN] jack** (page 42)

For connecting the included footswitch, or one of the separately sold accessories: the FC3A foot pedal (features Half-pedal function\*) or the FC4A/FC5 footswitch. These let produce a natural sustain as you play.

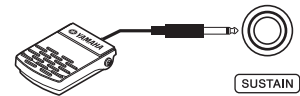

**[PEDAL UNIT] jack** (page 43)

For connecting one of the separately sold pedal units: LP-1 (for P-225) or LP-5A (for P-223). Both of them feature the Half-pedal function\*.

Make sure to assemble the unit on a separately sold Keyboard Stand (L-200 or L-100).

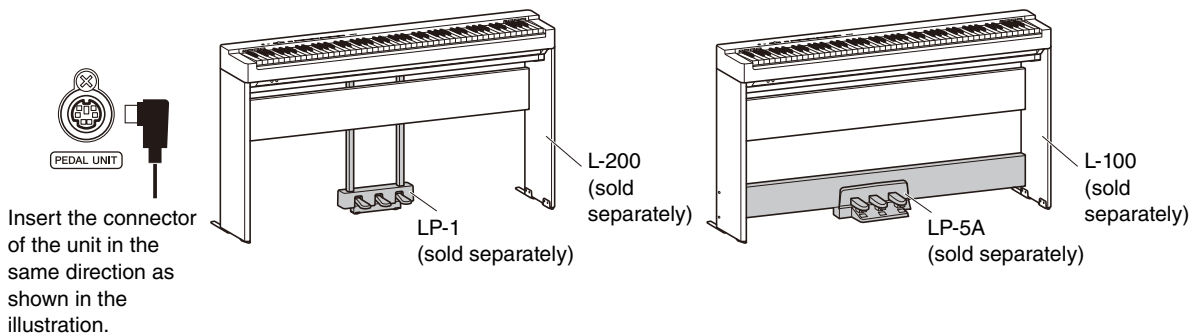

\*Half-pedal function: Allows you to vary the sustain length depending on how far the pedal is pressed.

**[USB TO HOST] terminal** (page 46)

For connecting to a computer or a smart device (smartphone, tablet, etc.) using a commercially available USB cable. When connected, you can send and receive both MIDI and audio data.

**NOTICE**

- Use an AB type USB cable of less than 3 meters. USB 3.0 cables cannot be used.

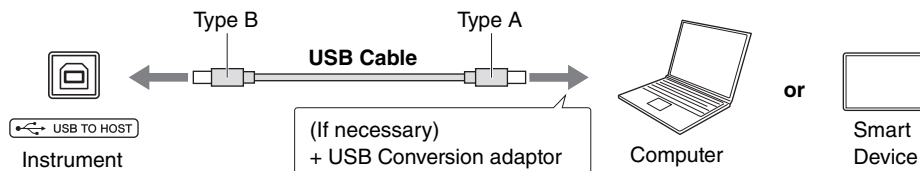

# Setting Up

## Power Requirements

Connect the AC adaptor in the order shown in the illustration.

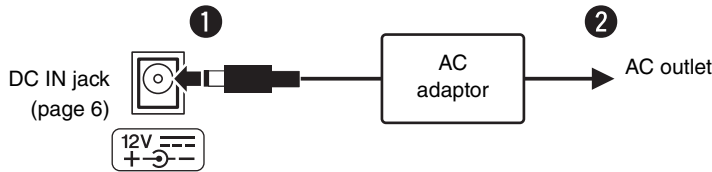

### ⚠ WARNING

- Use the included or specified AC adaptor (refer to the Specifications in the Owner's Manual). Using the wrong AC adaptor can result in damage to the instrument or overheating.
- When using the AC adaptor with a removable plug, make sure to keep the plug attached to the AC adaptor. Using the plug alone can cause electric shock or fire.
- Never touch the metallic section when attaching the plug. To avoid electric shock, short circuit or damage, also be careful that there is no dust between the AC adaptor and plug.
- When setting up the product, make sure that the AC outlet you are using is easily accessible. If some trouble or malfunction occurs, immediately turn the power off and disconnect the plug from the outlet.

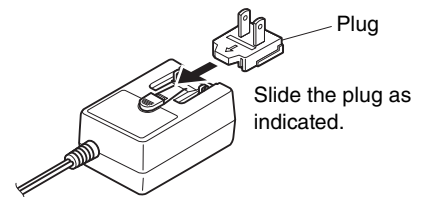

\* The shape of the plug differs depending on your area.

### NOTE

- Follow the order shown in reverse when disconnecting the AC adaptor.

## Turning the Power On/Off

- 1 Set the volume to the minimum.
- 2 Press the [⏻] (Standby/On) switch to turn on the power.

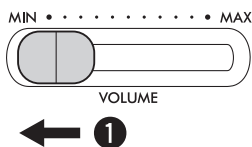

When the power is supplied to the instrument, the power lamp on the right of the [⏻] switch lights up.

While playing the keyboard, adjust the volume level by using the [VOLUME] slider.

To turn off the power, press the [⏻] (Standby/On) switch again for a second.

### ⚠ WARNING

- Even when the power switch is turned off, electricity is still flowing to the product at the minimum level. When you are not using the product for a long time, make sure to unplug the power cord from the wall AC outlet.

## Auto Power Off Function

To prevent unnecessary power consumption, this function automatically turns the power off if no buttons or keys are operated for approximately 30 minutes.

### Switching the Auto Power Off function (Enable/Disable)

**Default setting:** Enable

While holding down the [METRONOME] and [RHYTHM] buttons simultaneously, press the A#0 key to enable the Auto Power Off function or the A0 key to disable it.

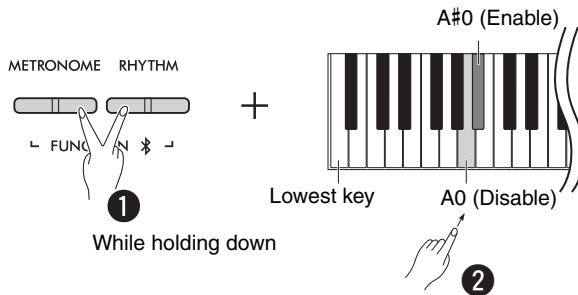

#### Disabling Auto Power Off (simple method)

Turn the power on while holding down the lowest key on the keyboard.

The [●] (Record) lamp flashes three times, indicating the Auto Power Off function has been disabled.

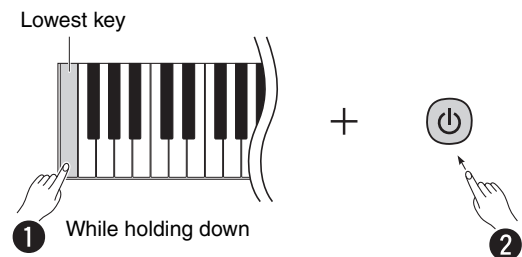

## Intelligent Acoustic Control (IAC)

IAC is a function which automatically adjusts and controls the sound quality according to the overall volume of the instrument. IAC Control is effective only on the sound that is output to the instrument speakers or headphones. Even when the volume is low, this lets you hear both low sounds and high sounds clearly. Especially when using headphones, the burden on the ears is reduced without the need for raising the overall volume excessively.

While holding down the [METRONOME] and [RHYTHM] buttons simultaneously, press the C2 key to turn the function off or the C#2 key to turn it on.

**Default setting:** On

### To adjust IAC depth:

While holding down the [METRONOME] and [RHYTHM] buttons simultaneously, press the D2 key to decrease the value by 1, D#2 to reset to the default value, or C#2 to increase by 1.

**Setting range:** -3 - 0 +3

**Default setting:** 0

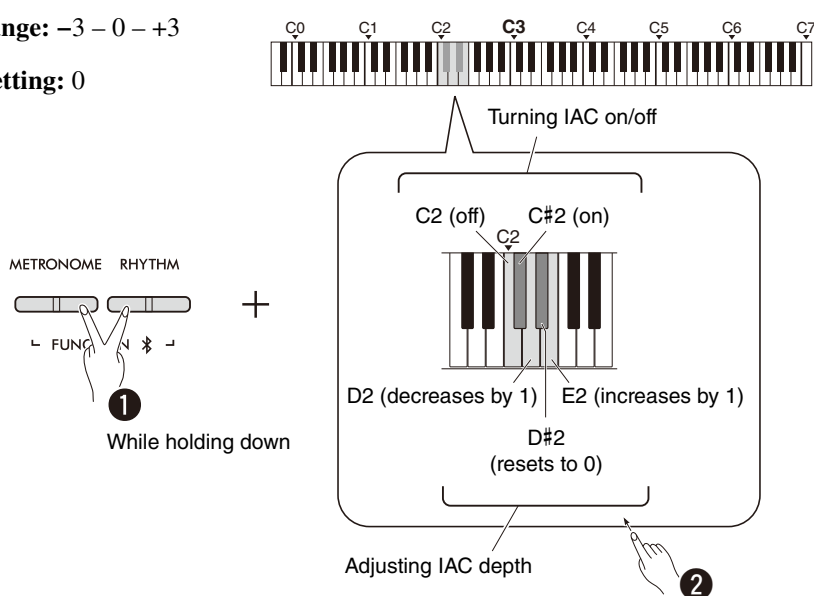

# Basic Operations

## Operations by using both buttons and keys

Certain functions of this instrument can be called up and operated using specific panel button/key combinations. In other words, a specifically assigned function can be controlled or adjusted by simultaneously holding down a certain button and pressing a certain key, which would turn the corresponding function on or off, or set its value, etc. (pages 21–35).

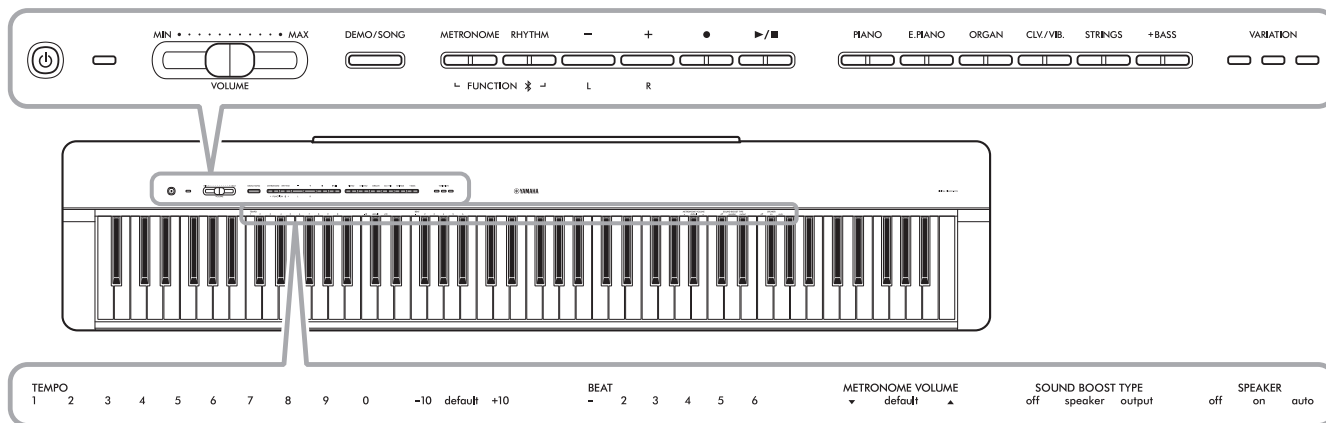

Certain commonly used functions and their values are printed here for ease in using the key operations.

A convenient “Quick Operation Guide” which shows only the key operations is available on the Yamaha website (page 2). If you print it out, you can place it on a music rest and use it to quickly reference the key operations.

## To turn on/off the Operation Confirmation Sounds:

By default, operations by using the button/key combinations produces a confirmation sound (“On,” “Off,” click, and tempo value input). To turn this sound on/off, simultaneously hold down the [METRONOME] and [RHYTHM] buttons, and then press the lowest key or second lowest key to turn the sound off or on.

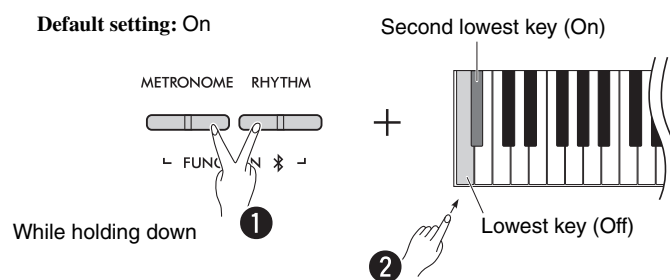

## Backup Parameters and Initializing

The following parameters will automatically be maintained even if you turn off the power.

- **User Song**
- **Backup Parameters:**
  - Metronome/Rhythm Volume..... pages 22, 28
  - Metronome Beat..... page 22
  - Touch Sensitivity..... page 33
  - Tuning ..... page 31
  - Auto Power Off setting ..... page 8
  - Operation Confirmation Sounds on/off..... page 10
  - Split Point..... page 15
  - IAC on/off ..... page 9
  - IAC Depth ..... page 9
  - Intro/Ending on/off..... page 28
  - AUX OUT volume settings ..... page 44
  - Stereophonic Optimizer on/off..... page 41
  - Speaker on/off ..... page 45
  - Wall EQ on/off ..... page 32
  - Bluetooth on/off ..... page 50

### NOTE

- The tempo value will not be maintained if you turn off the power.

### To initialize the backup parameters:

The backup parameters listed above can be initialized to their factory settings by simultaneously holding down the highest key and turning the power.

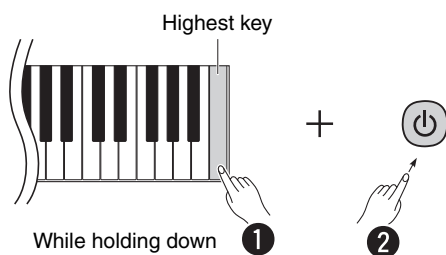

## Confirming the firmware version of this instrument

You can confirm the firmware version of your instrument by audible voice in English. While holding down the [METRONOME] and [RHYTHM] buttons simultaneously, press the B0 key.

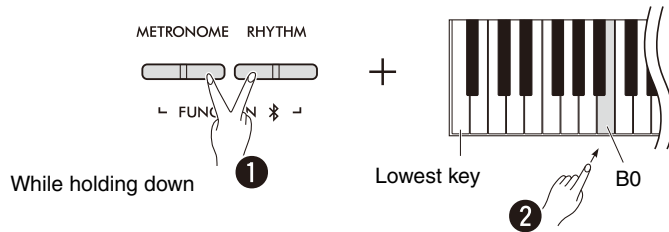

Yamaha may from time to time update firmware of the product without notice for improvement. Make sure to check our website for information of the latest release and upgrade the firmware for your instrument.

# Playing with Various Voices



## Selecting a Voice

Press one of the desired Voice (group) buttons.







Each press of the same button turns the [VARIATION] lamp on/off and selects one of four Voices in sequence.

### Voice List (Detailed)

Voice Button (Group)	Variation	Voice Name	Descriptions
	<input type="checkbox"/> <input type="checkbox"/> <input type="checkbox"/>	Grand Piano	This sound was sampled from a concert grand piano. It uses different samples depending on the strength of your playing and produces smoother tonal changes. Even the tonal changes produced by the damper pedal and the subtle sounds of releasing a key are reproduced. The sympathetic vibration (string resonance) that occurs among the strings of an acoustic piano has also been simulated. Suitable not only for classical compositions but also for piano pieces of any style.
	<input checked="" type="checkbox"/> <input type="checkbox"/> <input type="checkbox"/>	Live Grand	Spacious and clear piano with bright reverb. Good for popular music.
	<input type="checkbox"/> <input checked="" type="checkbox"/> <input type="checkbox"/>	Ballad Grand	Warm and soft piano sound. Good for relaxing music.
	<input type="checkbox"/> <input type="checkbox"/> <input checked="" type="checkbox"/>	Bright Grand	Bright piano sound. Clear tone helps the sound to “cut through” when playing in an ensemble.
	<input type="checkbox"/> <input type="checkbox"/> <input type="checkbox"/>	Stage E.Piano	The sound of an electric piano using hammer-struck metallic “tines.” Soft tone when played lightly, and an aggressive tone when played hard.
	<input checked="" type="checkbox"/> <input type="checkbox"/> <input type="checkbox"/>	DX E.Piano	An electronic piano sound created by FM synthesis. Extremely “musical” response with varying timbre according to keyboard dynamics. Good for standard popular music.
	<input type="checkbox"/> <input checked="" type="checkbox"/> <input type="checkbox"/>	Vintage E.Piano	A slightly different electric piano sound often heard in rock and popular music.
	<input type="checkbox"/> <input type="checkbox"/> <input checked="" type="checkbox"/>	Synth Piano	A synth-generated type electronic piano sound often heard in popular music. Used in the Dual mode it blends well with an acoustic piano Voice.
	<input type="checkbox"/> <input type="checkbox"/> <input type="checkbox"/>	Jazz Organ	A “tonewheel” type electric organ. Often heard in jazz and rock music. When the separately sold Pedal Unit (LP-1) is connected, the rotary speed of the “ROTARY SP” effect can be switched by using the left pedal.
	<input checked="" type="checkbox"/> <input type="checkbox"/> <input type="checkbox"/>	Rock Organ	Bright and edgy electric organ sound. Good for rock music.
	<input type="checkbox"/> <input checked="" type="checkbox"/> <input type="checkbox"/>	Organ Principal	A typical pipe organ sound (8 feet + 4 feet + 2 feet). Good for sacred music from the Baroque period.
	<input type="checkbox"/> <input type="checkbox"/> <input checked="" type="checkbox"/>	Organ Tutti	This is the organ’s full coupler sound often associated with Bach’s “Toccatina and Fugue.”

(Go to next page.)

Voice Button (Group)	Variation	Voice Name	Descriptions
<b>P-225</b> CLV./VIB. 	<input type="checkbox"/> <input type="checkbox"/> <input type="checkbox"/>	E.Clavichord	A hammer-struck keyboard instrument that utilizes an electric pickup that is often heard in funk and soul music. Its tone is noted for the unique sound produced when the keys are released.
	<input checked="" type="checkbox"/> <input type="checkbox"/> <input type="checkbox"/>	Vibraphone	Played with relatively soft mallets. The tone becomes more metallic the harder you play. When the separately sold Pedal Unit (LP-1) is connected, the left pedal switches Vibrato on and off.
	<input type="checkbox"/> <input checked="" type="checkbox"/> <input type="checkbox"/>	Harpsichord 8'	The definitive instrument for baroque music. Authentic harpsichord sound, with plucked strings, no touch response, and characteristic key-release sound.
	<input type="checkbox"/> <input type="checkbox"/> <input checked="" type="checkbox"/>	Harpsi.8'+4'	Mixes the same Voice an octave higher for a more brilliant tone.
<b>P-223</b> STRINGS 	<input type="checkbox"/> <input type="checkbox"/> <input type="checkbox"/>	Strings	Stereo-sampled, large-scale strings ensemble with realistic reverb. Try combining this Voice with piano in the Dual mode.
	<input checked="" type="checkbox"/> <input type="checkbox"/> <input type="checkbox"/>	Slow Strings	Spacious strings ensemble with a slow attack. Try combining this Voice with a piano or electric piano in the Dual mode.
	<input type="checkbox"/> <input checked="" type="checkbox"/> <input type="checkbox"/>	Choir	A big, spacious choir Voice. Perfect for creating rich harmonies in slow pieces.
	<input type="checkbox"/> <input type="checkbox"/> <input checked="" type="checkbox"/>	Synth Pad	A warm, mellow, and spacious synth sound. Ideal for sustained parts in the back- ground of an ensemble.
<b>P-225</b> CLV./VIB. 	<input type="checkbox"/> <input type="checkbox"/> <input type="checkbox"/>	Strings	Stereo-sampled, large-scale strings ensemble with realistic reverb. Try combining this Voice with piano in the Dual mode.
	<input checked="" type="checkbox"/> <input type="checkbox"/> <input type="checkbox"/>	Slow Strings	Spacious strings ensemble with a slow attack. Try combining this Voice with a piano or electric piano in the Dual mode.
	<input type="checkbox"/> <input checked="" type="checkbox"/> <input type="checkbox"/>	Choir	A big, spacious choir Voice. Perfect for creating rich harmonies in slow pieces.
	<input type="checkbox"/> <input type="checkbox"/> <input checked="" type="checkbox"/>	Synth Pad	A warm, mellow, and spacious synth sound. Ideal for sustained parts in the back- ground of an ensemble.
<b>P-223</b> STRINGS 	<input type="checkbox"/> <input type="checkbox"/> <input type="checkbox"/>	Harpsichord 8'	The definitive instrument for baroque music. Authentic harpsichord sound, with plucked strings, no touch response, and characteristic key-release sound.
	<input checked="" type="checkbox"/> <input type="checkbox"/> <input type="checkbox"/>	Harpsi.8'+4'	Mixes the same Voice an octave higher for a more brilliant tone.
	<input type="checkbox"/> <input checked="" type="checkbox"/> <input type="checkbox"/>	Accordion	An accordion sound often used for tango and chanson music.
	<input type="checkbox"/> <input type="checkbox"/> <input checked="" type="checkbox"/>	Gu Zheng	The sound of the traditional koto can be used for solo performance, accompaniment, ensemble performance, and many other situations. You can play single notes and tremolo depending on your touch.
+BASS 	<input type="checkbox"/> <input type="checkbox"/> <input type="checkbox"/>	Acoustic Bass	An upright bass played fingerstyle. Ideal for jazz and Latin music.
	<input checked="" type="checkbox"/> <input type="checkbox"/> <input type="checkbox"/>	Electric Bass	Electric bass for a wide range of music styles, including jazz, rock, popular, and more.
	<input type="checkbox"/> <input checked="" type="checkbox"/> <input type="checkbox"/>	Bass & Cymbal	Adds a cymbal Voice to the bass sound. Ideal for walking bass lines in jazz tunes.
	<input type="checkbox"/> <input type="checkbox"/> <input checked="" type="checkbox"/>	Fretless Bass	The sound of a fretless bass. Suitable for styles such as jazz and fusion.

For details on the characteristics of each Voice, listen to the Voice Demo Songs (page 20).

## Playing two different Voices with your left and right hands (Split)

Pressing the [+BASS] button changes the Voice for the Left section (F#2 key and all keys to the left) to one of the bass Voices. This enables you to play two different Voices with your left and right hands (Split function). The bass Voice changes in sequence each time the [+BASS] button is pressed.

Select the Voice for the Right first, and then for the Left.

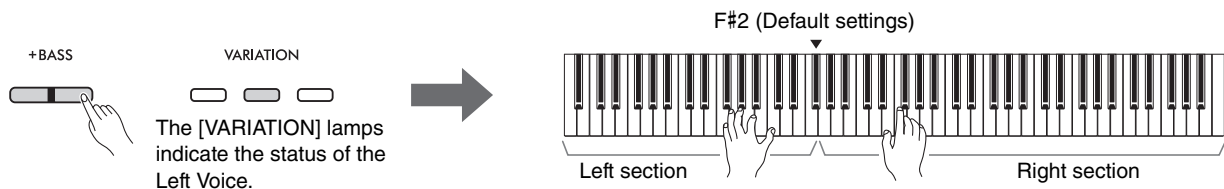

To exit from the Split function in order to return to the same Voice for Left and Right, press any Voice button.

### NOTE

- When a separately sold pedal unit is connected, the right pedal will not affect the Left Voice if a bass Voice is selected.

## To change the Left Voice to any Voice other than bass:

While holding down the [+BASS] button, select a desired Voice by pressing the Voice button several times as necessary.

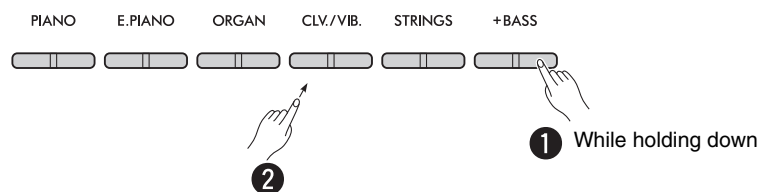

## To change the Split Point:

The highest key of the Left section is referred to as "Split Point," and is set by default to F#2, though it can be changed as desired. While holding down the [+BASS] button, press the desired key.

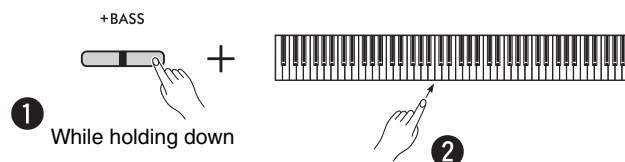

## To shift the Octave for each Voice:

You can shift the Octave setting independently for the Left and Right Voices.

While holding down the [PIANO] button, press one of the F5–B5 keys.

**Setting range:** -2 – +2

**Default settings:** Depends on the Voice combination

Left section (Voice 2)	F5	Down by 1 octave	Right section (Voice 1)	A5	Down by 1 octave
	F#5	Default setting (depends on the Voice combination)		A#5	Default setting (depends on the Voice combination)
	G5	Up by 1 octave		B5	Up by 1 octave

## To adjust the volume balance between two Voices:

While holding down the [PIANO] button, press any of the C5–D5 keys.

**Setting range:** -6 – 0 – +6    **Default setting:** 0

Right section ◀ [Slider] ▶

Setting Value -6 ····· 0 ····· +6

Left section ▶ [Slider] ◀

Positive settings make the Right Voice louder while negative settings make the Left Voice louder.

## Layering Two Voices in Different Voice Groups (Dual)

First, select two desired Voices from different Voice groups, and then press those Voice buttons simultaneously to enable the Dual function.

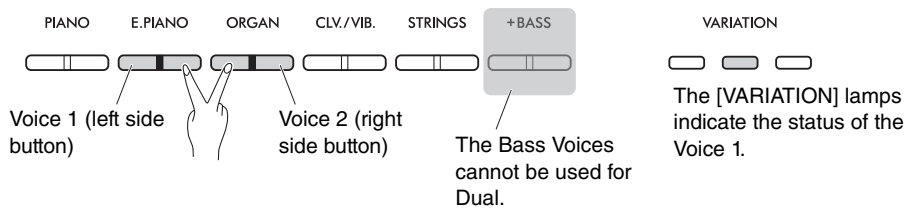

**NOTE**

- Two Voices which belongs to the same button cannot be layered.
- The Dual function cannot be used while the Duo function (page 18) is on.

To exit from the Dual function, press any Voice button.

## To shift the Octave for each Voice:

You can shift the Octave setting independently for Voice 1 and Voice 2. While holding down the [PIANO] button, press any of the F5–B5 keys.

**Setting range:** -2 – +2

**Default settings:** Depends on the Voice combination

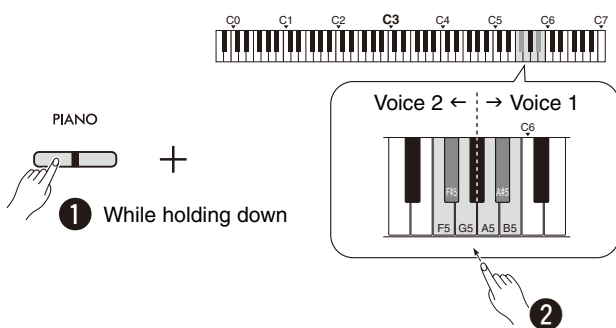

<b>Voice 2</b>	F5	Down by 1 octave	<b>Voice 1</b>	A5	Down by 1 octave
	F#5	Default setting (depends on the Voice combination)		A#5	Default setting (depends on the Voice combination)
	G5	Up by 1 octave		B5	Up by 1 octave

## To adjust the volume balance between two Voices:

While holding down the [PIANO] button, press any of the C5–D5 keys.

**Setting range:** -6 – 0 – +6 **Default setting:** 0

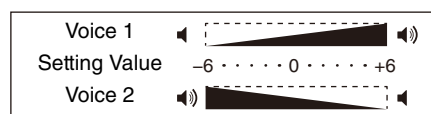
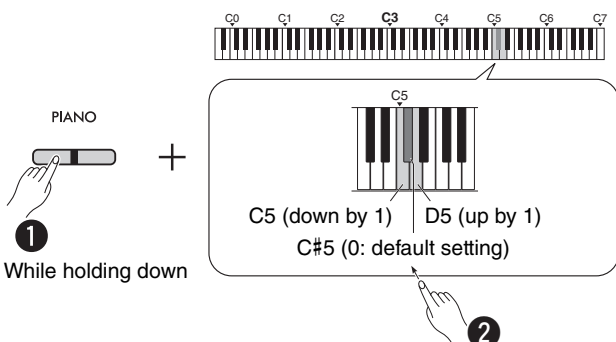

Positive settings make Voice 1 louder while negative settings make Voice 2 louder.

## Playing Duo

This function divides the keyboard area into two sections (left side and right side) and allows two different players to play the respective keyboard area with the same Voice sounding with the same octave.

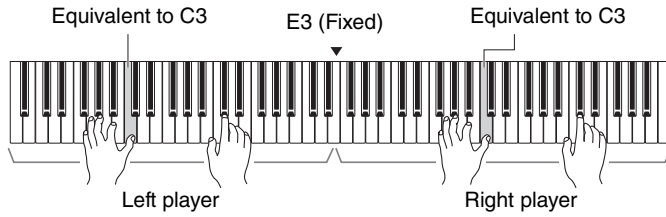

To turn the Duo function on/off, hold down the [PIANO] button and simultaneously press the [-] and [+] buttons.

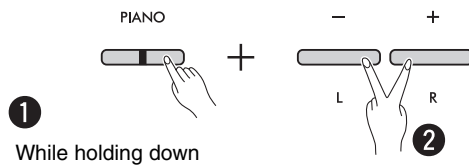

**NOTE**

- The Bass Voices cannot be used for Duo.
- The Split Point for Duo cannot be changed from E3.
- When the Duo Type (page 19) is set to “Separate,” the Reverb Depth (page 35) is set to 0 and the Stereophonic Optimizer (page 41) is turned off.
- When Duo is on, the VRM Lite (page 34) function is turned off.

### To shift the Octave for each keyboard area:

You can shift the Octave setting independently for the Left and Right player areas.

While holding down the [PIANO] button, press any of the F5–B5 keys.

**Setting range:** -2 – +2    **Default setting:** Depends on the Voice combination

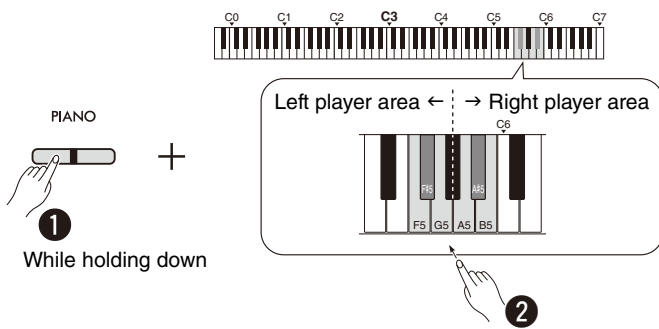

<b>Left player area</b>	F5	Down by 1 octave	<b>Right player area</b>	A5	Down by 1 octave
	F#5	Default setting (depends on the Voice combination)		A#5	Default setting (depends on the Voice combination)
	G5	Up by 1 octave		B5	Up by 1 octave

## To adjust the volume balance between two Voices:

While holding down [PIANO], press any of the C5–D5 keys.

**Setting range:** -6 – 0 – +6    **Default setting:** 0

Right player area ◀ [Slider] ▶

Setting Value -6 ····· 0 ····· +6

Left player area ▶ [Slider] ◀

Positive settings make the Right player Voice louder while negative settings make the Left player Voice louder.

## To set the speaker setting when Duo is on (Duo Type):

When the Duo is on, by default, the keyboard sound via the left player will be heard from the left speaker while the keyboard sound via the right player will be heard from the right speaker.

This setting can be changed by holding down the [PIANO] button and pressing F4 (Balanced) or F#4 (Separate) key.

**Default setting:** Separate

F#4 (Separate)

F4 (Balanced)

### Duo Type List

Key	Type	How the keyboard sound is output
F4	Balanced	The keyboard sound mixed with both the left and right players will be heard from the left and right speakers in stereo.
F#4	Separate	The keyboard sound via the left player will be heard from the left speaker while the keyboard sound via the right player will be heard from the right speaker.

## Discovering the Voices with the Voice Demo Songs

Pressing the [DEMO/SONG] button starts playback of all Demo Songs from the Grand Piano Voice (page 13) in sequence.

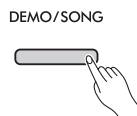

To listen to the desired Voice Demo Song, simultaneously hold down the [DEMO/SONG] button and select the desired Voice (page 13).

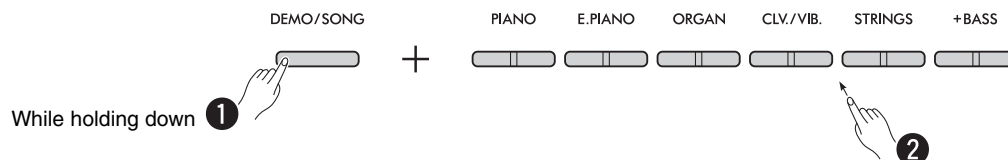

Refer to page 24 for changing the Demo Song during playback or adjusting the tempo.

To stop playback, press the [DEMO/SONG] or the [▶/■] (Play/Stop) button.

Special individual Demo Songs are provided for all of the Voices of the instrument except for Electric Bass, Bass & Cymbal, and Fretless Bass (page 14). The demonstration pieces listed below are short, rearranged excerpts of the original compositions. All other Songs are original (©Yamaha Corporation).

### Demo Song List

Voice Name	Title	Composer
Ballad Grand	Intermezzo, 6 Stücke, op.118-2	J. Brahms
Organ Principal	Herr Christ, der ein'ge GottesSohn, BWV 601	J.S. Bach
Organ Tutti	Triosonate Nr.6, BWV 530	J.S. Bach
Harpsichord 8'	Concerto a cembalo obbligato, 2 violini, viola e continuo No.7, BWV 1058	J.S. Bach
Harpsi.8'+4'	Gigue, Französische Suiten Nr.5, BWV 816	J.S. Bach

# Using the Metronome

The Metronome is convenient for practicing with an accurate tempo.

## Basic Operations

Press the [METRONOME] button to start/stop the Metronome.

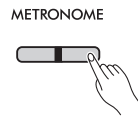

### To adjust the tempo:

**Setting range:** 5–280 (Default setting: 120)

When the metronome is playing back, press [+] to increase or [-] to decrease. While holding down the [METRONOME] button, press the lowest key to confirm the current tempo value by voice (in English).

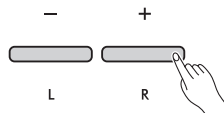

Holding either button continuously increases or decreases the value.

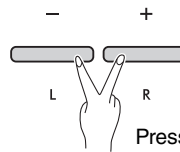

Pressing the buttons simultaneously resets to the default setting.

To make various settings for the Metronome, simultaneously hold down the [METRONOME] button and press the corresponding key simultaneously.

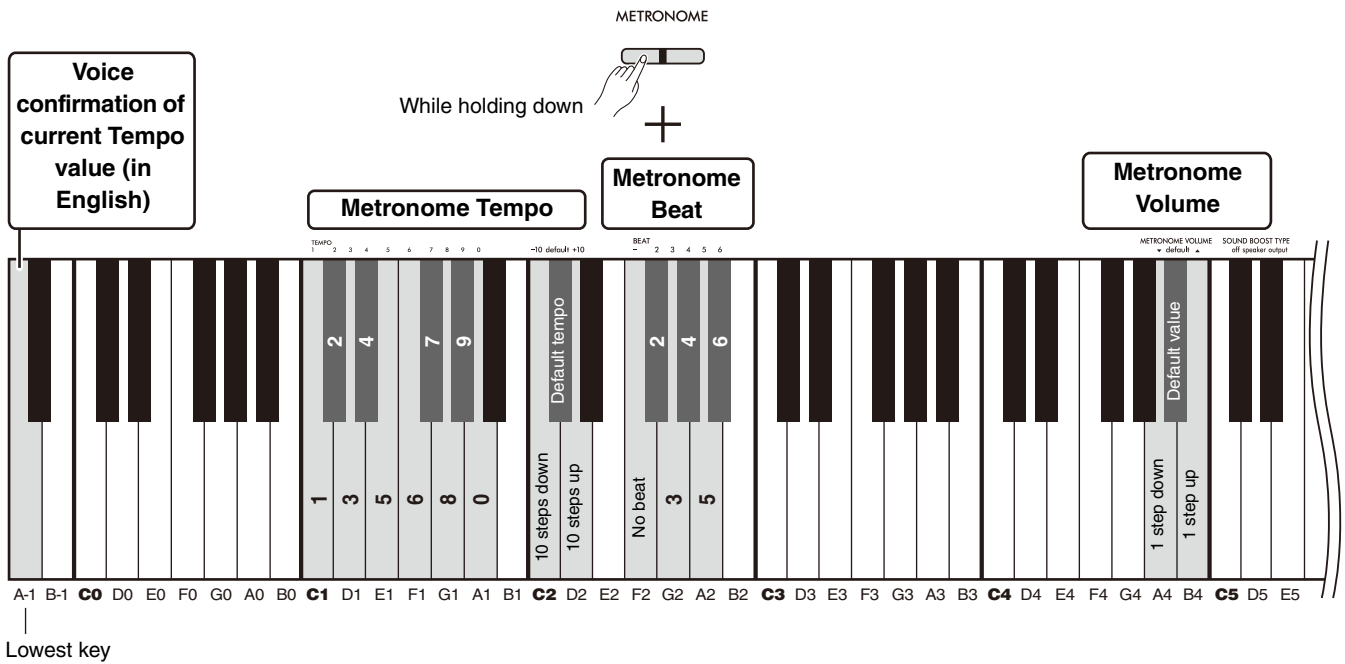

Function	Descriptions	Default setting	Setting range
Voice confirmation of current Tempo value (in English)	Reads out the current Metronome tempo by voice (in English).	-	-
Metronome Tempo	<p><b>To set the desired Tempo value directly:</b> While holding down the [METRONOME] button, press the appropriate keys from C1–A1. For example, 80 can be set by pressing G1 (8) and then A1 (0).</p> <p><b>To increase or decrease the Tempo value by 10:</b> While holding down the [METRONOME] button, press the C2 key (to decrease) or D2 (to increase).</p>	120	5–280
Metronome Beat	While holding down the [METRONOME] button, press one of the F2–A#2 keys to set the Metronome Beat.	0 (no beat)	0 (no beat), 2, 3, 4, 5, 6 beats
Metronome Volume	While holding down the [METRONOME] button, press the A4 key (to decrease by 1) or B4 key (to increase by 1) to set the Metronome Volume. Pressing A#4 will reset the volume to the default setting.	7	1–10

# Playing Back Songs

This instrument contains 50 preset piano Songs. Select and play back a Song from the Song List below.

## Basic Operations

1. While holding down the [DEMO/SONG] button, press the key corresponding to the desired preset Song between C2–C#6 (see the illustration below) to start playback.  
The preset Songs will play back in sequence continuously, starting with the selected Song.
2. Press the [DEMO/SONG] or [▶/■] (Play/Stop) button to stop playback.

## Quick Play (skipping silence at the top of a Song)

When playing back a Song which has a short silence before the first note, you can determine how the Song starts in one of two ways:

A#-1 (On: Default setting)

Playback starts directly from the first note, skipping the silence at the beginning.

A-1 (Off)

Playback starts from the beginning of the Song data, including any silence that precedes the first note.

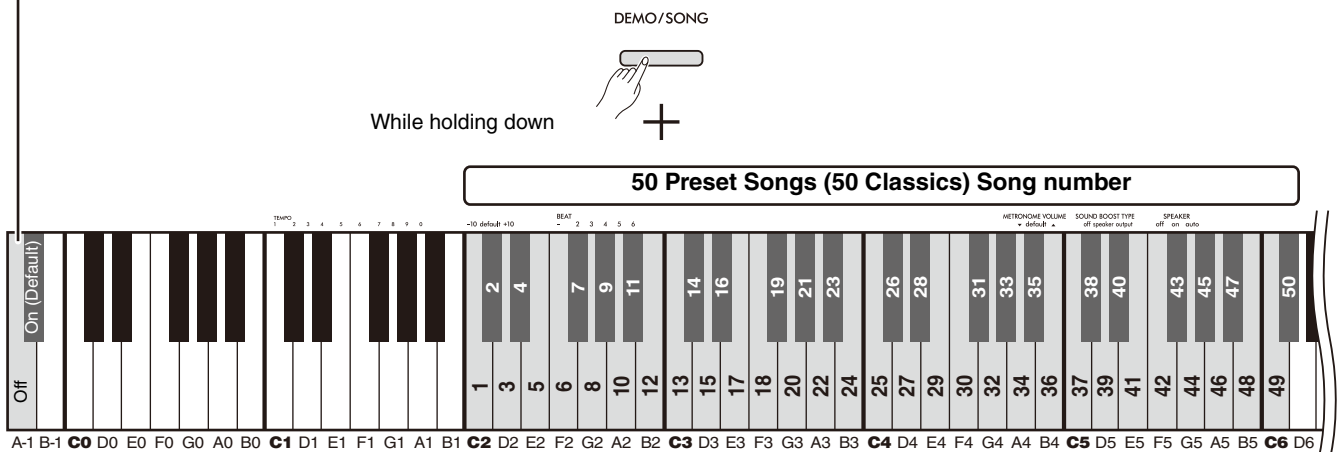

Lowest key

## 50 Preset Songs (50 Classics) Song number / Song name

1 Canon D dur	14 Clair de lune	27 Piano Sonate op.27-2 "Mondschein" 1st mov.	40 Blumenlied
2 Air On the G String	15 Jupiter (The Planets)	28 Impromptu op.90-2	41 Humoresque
3 Jesus, Joy of Man's Desiring	16 Menuett (Eine kleine Nachtmusik K.525)	29 Frühlingslied op.62-6	42 Arietta
4 Twinkle, Twinkle, Little Star	17 Menuett G dur	30 Fantaisie-Impromptu	43 Tango (España)
5 Piano Sonate op.31-2 "Tempest" 3rd mov.	18 Marcia alla Turca	31 Etude op.10-3 "Chanson de l'adieu"	44 The Entertainer
6 Ode to Joy	19 Piano Concerto No.1 op.11 2nd mov.	32 Etude op.10-12 "Revolutionary"	45 Maple Leaf Rag
7 Wiegenlied op.98-2	20 The Nutcracker Medley	33 Valse op.64-1 "Petit chien"	46 La Fille aux Cheveux de Lin
8 Grande Valse Brillante	21 Prelude (Wohltemperierte Klavier I No.1)	34 Nocturne op.9-2	47 Arabesque No.1
9 Polonaise op.53 "Héroïque"	22 Menuett G dur BWV Anh.114	35 Nocturne KK4a-16/BI 49 [Posth.]	48 Cakewalk
10 La Campanella	23 Piano Sonate No.15 K.545 1st mov.	36 Träumerei	49 Je te veux
11 Salut d'amour op.12	24 Turkish March	37 Barcarolle	50 Gymnopédies No.1
12 From the New World	25 Piano Sonate op.13 "Pathétique" 2nd mov.	38 La prière d'une Vierge	
13 Sicilienne	26 Für Elise	39 Liebesträume No.3	

### To play back the selected Song repeatedly:

While holding down the [DEMO/SONG] button, press the key corresponding to the desired Song for more one second. Note that repeated playback will not be applied to Voice Demo Songs (page 20) and User Songs (page 36).

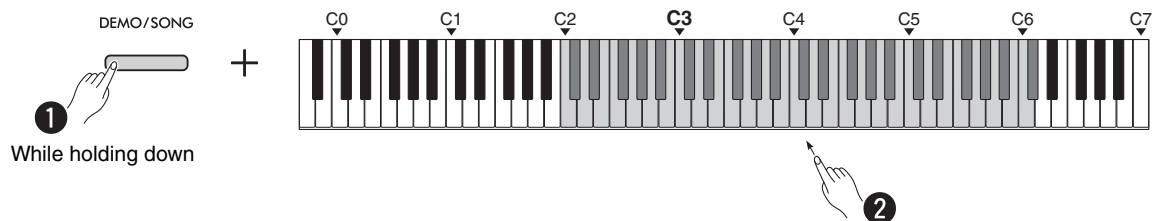

### To change the Song during playback:

Press the [-] or [+] button while a selected Song is being played back.

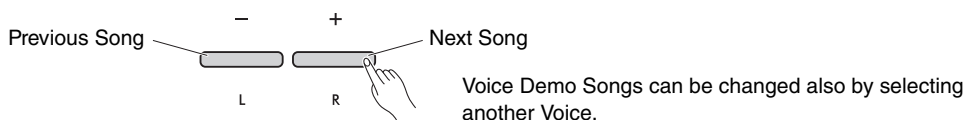

### To adjust the playback tempo:

While holding down the [METRONOME] button, press the [-] or [+] button.

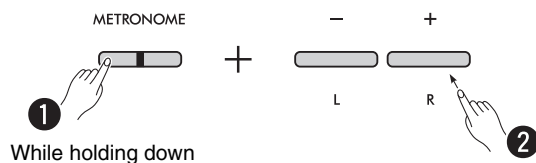

### To start playback from the top of the current Song during playback:

During Song playback, pressing the [-] and [+] buttons simultaneously returns to the top and plays the current Song from the beginning.

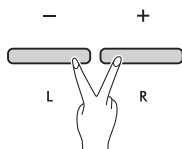

## Playing back a Song while Muting the Right or Left Part

By muting the Right part (R) or the Left part (L) of a Song, you can practice the muted part while listening to another part. To mute either part, simultaneously hold down the [▶/■] (Play/Stop) button and press the [R] or [L] button that you want to mute during Song playback.

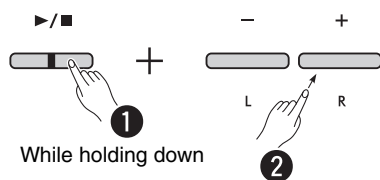

### NOTE

- The Rhythm part of a User Song cannot be muted.

# Adding Accompaniment to Your Performance (Rhythm)

This instrument features a powerful Rhythm function, consisting of drum and bass accompaniment patterns (page 27), allowing you to play along with your favorite rhythmic backing tracks.

## Basic Operations

### 1. Press the [RHYTHM] button to start Rhythm.

The percussion part starts from the Intro section.

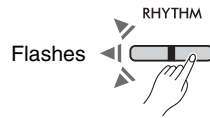

#### NOTE

- If you start Rhythm playback during Song playback, the Intro section will not be played back.

#### To select a different Rhythm:

While holding down the [RHYTHM] button, press a key between F2 and C4 (page 28).

#### To adjust the tempo:

**Setting range:** 5–280 (Default setting: 120)

When the rhythm is playing back, press [+] to increase or [-] to decrease.

While holding down the [RHYTHM] button, press the lowest key to confirm the current tempo value by voice (in English).

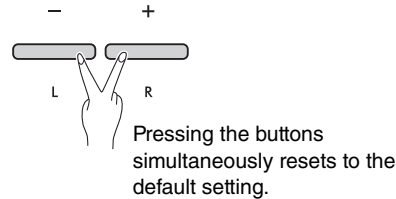
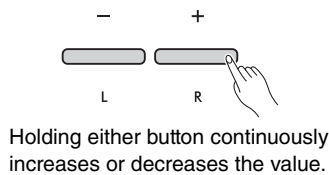

#### NOTE

- The Rhythm tempo setting is reflected also in the Metronome.

### 2. Play the keyboard along with the Rhythm.

The instrument creates accompaniment bass notes according to the notes you play. Simply press one or two notes and the instrument recognizes the appropriate chord type.

#### NOTE

- 9th, 11th and 13th chords cannot be recognized by this instrument.
- Regarding on how to specify chords, refer to the commercially available Chord Table booklet.

### 3. Press the [RHYTHM] button to stop playback.

**Rhythm List**

Category	Key	Name
Pop&Rock	F2	8Beat
	F#2	16Beat
	G2	Shuffle1
	G#2	Shuffle2
	A2	Shuffle3
	A#2	Gospel
	B2	8BeatBallad
	C3	6-8SlowRock
Jazz	C#3	FastJazz
	D3	SlowJazz
	D#3	Swing
	E3	JazzWaltz
Latin	F3	Samba
	F#3	BossaNova
	G3	Rumba
	G#3	Salsa
Kids&Holiday	A3	KidsPop
	A#3	6-8March
	B3	ChristmasSwing
	C4	Christmas3-4

To make various settings for the Rhythm, hold down the [RHYTHM] button and press the corresponding key simultaneously.

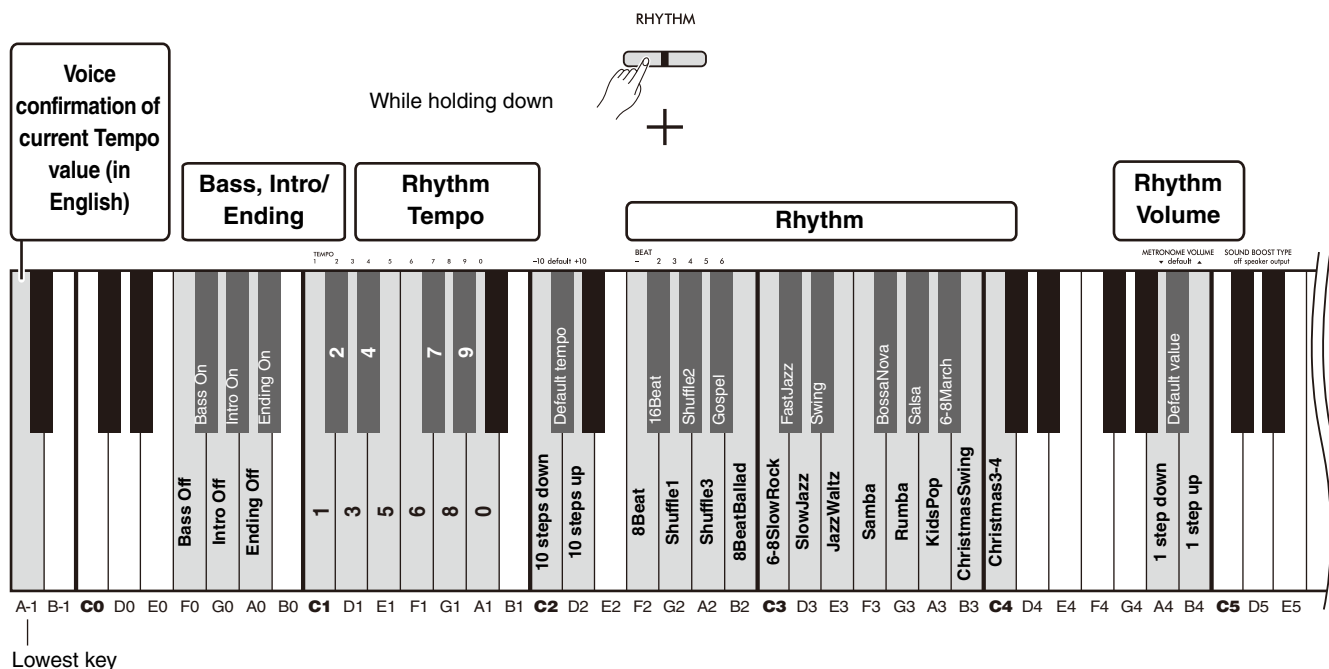

Function	Descriptions	Default setting	Setting range
Voice confirmation of current Tempo value (in English)	Reads out the current Rhythm tempo by voice (in English).	-	-
On/Off settings of the Bass sound and Intro/Ending	<p><b>To turn on or off the Bass sound of the selected Rhythm:</b> While holding down the [RHYTHM] button, press the F0 key (off) or F#0 (on).</p> <p><b>To select whether the Intro/Ending is added or not at the beginning/ending of Rhythm playback:</b> While holding down the [RHYTHM] button, press one of the G0/A0 keys (off) or G#0/A#0 (on).</p>	On	On/Off
Rhythm Tempo	<p><b>To set the desired Tempo value directly:</b> While holding down the [RHYTHM] button, press the appropriate keys from C1–A1. For example, 80 can be set by pressing G1 (8) and then A1 (0).</p> <p><b>To increase or decrease the Tempo value by 10:</b> While holding down the [RHYTHM] button, press the C2 key (to decrease) or D2 (to increase).</p>	120	5–280
Rhythm	While holding down the [RHYTHM] button, press the appropriate keys for the desired Rhythm from F2–C4. For details, refer to the Rhythm List (page 27).	-	-
Rhythm Volume	While holding down the [RHYTHM] button, press the A4 key (to decrease by 1) or B4 (to increase by 1) to set the Rhythm Volume. Pressing the A#4 will reset the volume to the default setting.	7	1–10

# Useful Performance Settings

This instrument features also the following functions useful for your performance.

## Sound Boost

This function boosts the overall sound and makes the weak tones as well as the strong tones sound more clearly. Select the desired setting from “speaker,” “output,” and “off” depending on your performance situation.

While holding down the [METRONOME] and [RHYTHM] buttons, press one of the C#5–D#5 keys.

**Default setting:** off

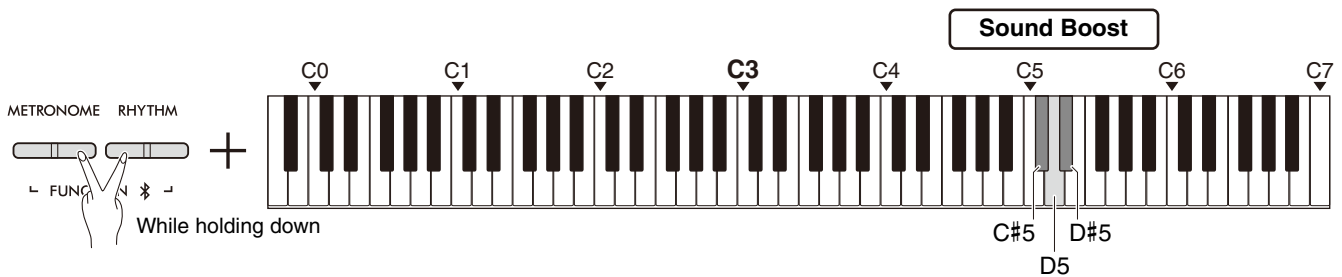

### Sound Boost Type List

Key	Type	Descriptions
C#5	speaker	Boosts the speaker sound of this instrument. This setting enhances the presence of the keyboard sound, to help your sound stand out when playing along with other instruments or in noisy environments.
D5	output	Boosts the sound output from the instrument (for example, external speakers connected to the AUX OUT jacks, smartphone connected to the [USB TO HOST] terminal, or headphones connected to the [PHONES] jack). This setting is recommended for sharing or playing back your performances recorded to one of the smart device apps, Rec'n'Share or Smart Pianist (page 48), via audio recording (page 46). Each individual sound will be heard clearly.
D#5	off	No effect.

## Transpose

You can shift or transpose the pitch of the entire keyboard up or down in semitone steps. This lets you easily match the pitch of the keyboard to the range of other instruments. For example, if you enter a transpose setting of “+5,” playing a C key will produce a F pitch.

While holding down the [METRONOME] and [RHYTHM] buttons, press one of the F#2–F#3 keys.

**Setting range:** -6 (F#2) – 0 (C3) – +6 (F#3)

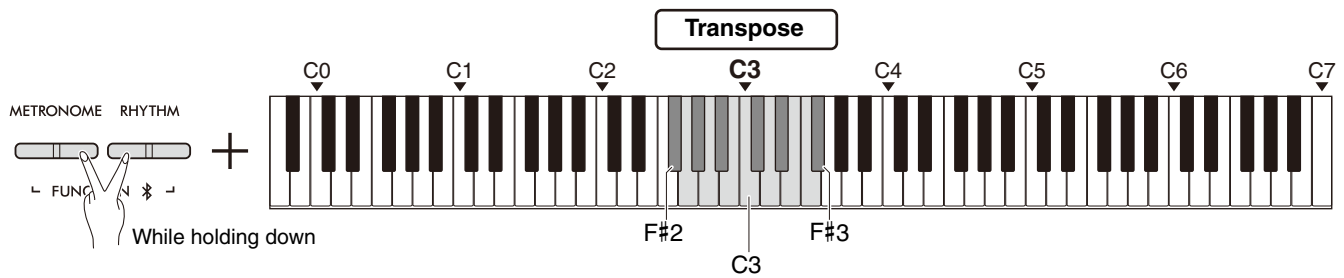

Key	Descriptions
F#2–B2	Shifts the pitch down from normal in semitone steps.
C3	Resets the pitch to normal.
C#3–F#3	Shifts the pitch up from normal in semitone steps.

## Tuning

You can fine tune the pitch of the entire instrument. This can be extremely useful when playing your digital piano along with other instruments.

**Default setting:** 440.0 Hz

**Setting range:** 414.8 Hz–440.0 Hz–466.8 Hz

### To set the Tuning value directly to 440.0 Hz or 442.0 Hz:

While holding down the [METRONOME] and [RHYTHM] buttons, press the C1 or C#1 key.

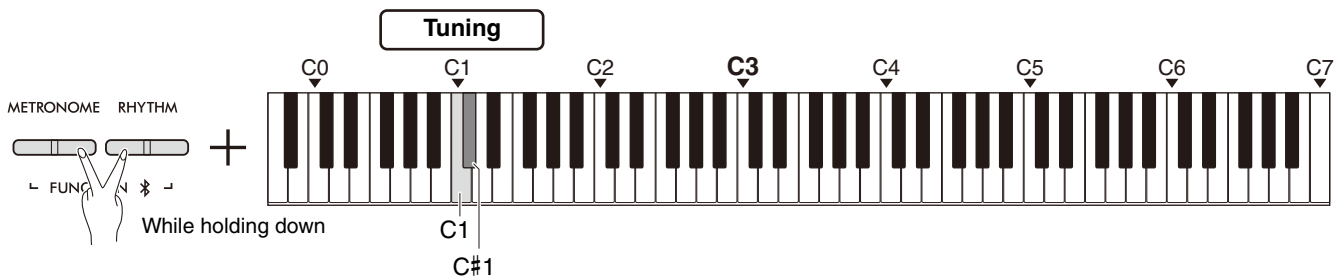

Key	Descriptions
C1	Sets the Tuning value of A3 to 440.0 Hz.
C#1	Sets the Tuning value of A3 to 442.0 Hz.

### To set the Tuning value other than 440.0 Hz or 442.0 Hz:

While holding down the [METRONOME] and [RHYTHM] buttons, press the [-] or [+] buttons to decrease or increase the value by 0.2 Hz. Pressing the [-] and [+] buttons simultaneously will reset the value to the default one (440.0 Hz).

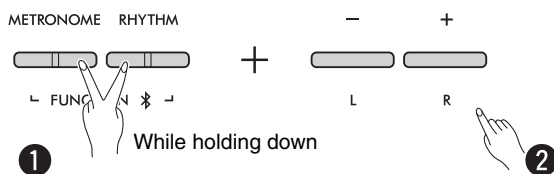

## Wall EQ

This function will maintain clear sound even if the instrument is located closely to a wall.

While holding down the [METRONOME] and [RHYTHM] buttons, press the D6 or D#6 key.

**Default setting:** Off

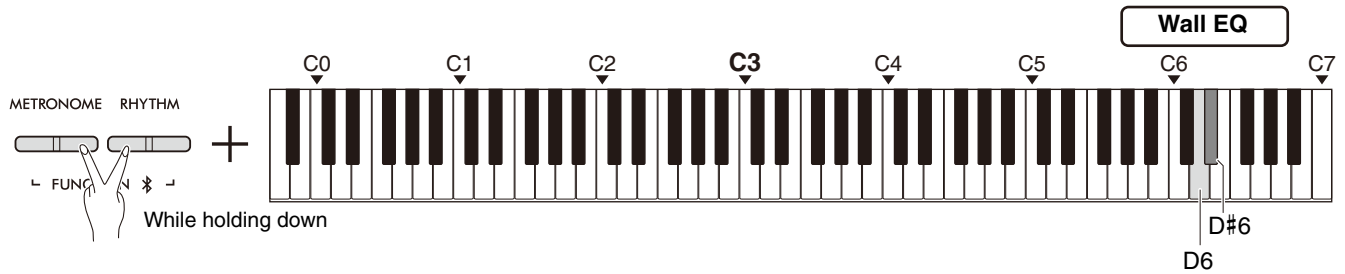

Key	Descriptions
D6	Turns the Wall EQ off.
D#6	Turns the Wall EQ on.

## Touch Sensitivity

When you play with a Voice (excepting organ or harpsichord), you can specify the degree of Touch Sensitivity (how the sound responds to your playing strength). There are four Touch Sensitivity types to select from: Soft, Medium, Hard, and Fixed.

While holding down the [PIANO] buttons, press one of the C6–D#6 keys.

**Default setting:** Medium

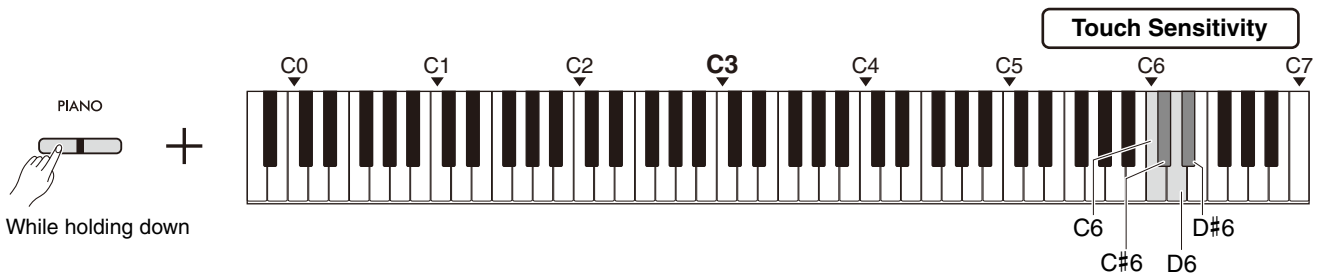

### Touch Sensitivity List

Key	Touch Sensitivity	Descriptions
C6	Soft	Produces relatively high volume even with light playing strength.
C#6	Medium	Standard Touch Sensitivity.
D6	Hard	Requires strong playing to produce high volume.
D#6	Fixed	The volume level will be the same regardless of how hard you play the keys.

## Virtual Resonance Modeling Lite (VRM Lite)

Virtual Resonance Modeling Lite (VRM Lite) is a technology which reproduces the string resonance sound unique to the real acoustic piano. You can feel this effect when playing a chord or pressing the damper pedal of the pedal unit (page 43). This VRM effect is applied only to piano Voices (page 13).

To turn this function on or off, simultaneously hold down the [PIANO] button and press the C3 (off) or C#3 (on) key.

**Default settings: On**

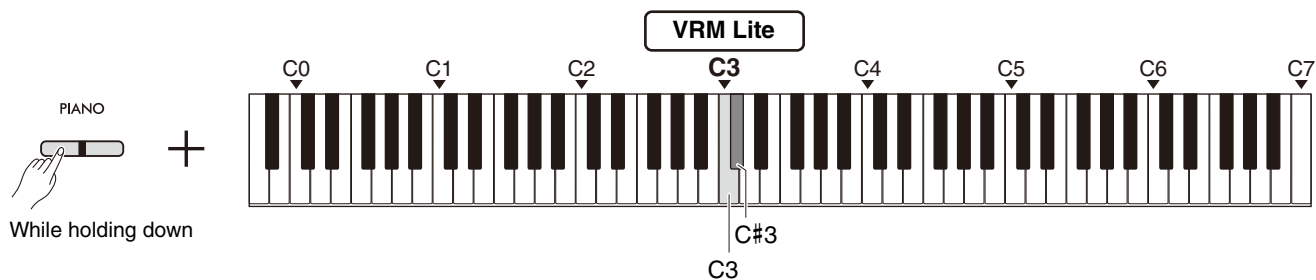

Key	Descriptions
C3	Turns the VRM Lite effect off.
C#3	Turns the VRM Lite effect on.

## Reverb

This lets you add reverberation similar to that of a concert hall to individual Voices. Whenever you select a Voice, the most suitable Reverb Type will be automatically selected; however, you can select another Reverb Type as desired.

To select the Reverb Type, simultaneously hold down the [PIANO] button and press any of the C2–E2 keys.

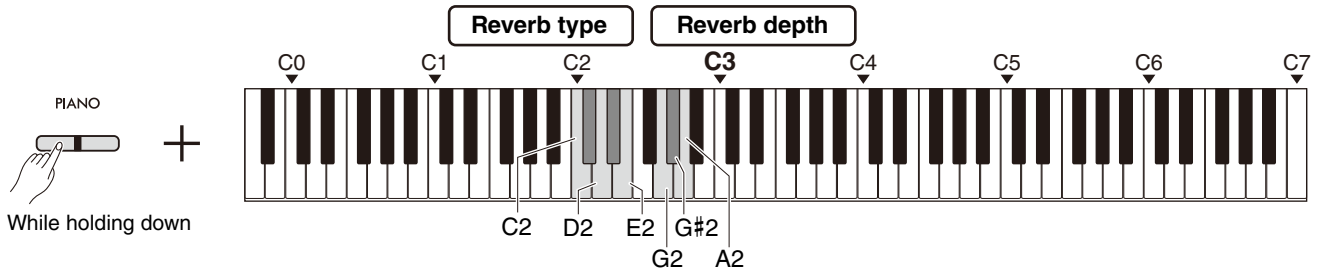

### Reverb Type List

Key	Type	Descriptions
C2	Recital Hall	Simulates the clear reverberation in a mid-sized hall suitable for piano recital.
C#2	Concert Hall	Simulates the brilliant reverberation in a large hall for public orchestra performances.
D2	Chamber	Simulates the elegant reverberation in a small room suitable for chamber music.
D#2	Club	Simulates the lively reverberation in a jazz club or a small bar.
E2	Off	No effect.

### To set the Reverb depth of the keyboard sound:

While holding down the [PIANO] button, press any of the G2–A2 keys to set the Reverb depth only of the keyboard sound.

**Setting range:** 0–20

Key	Descriptions
G2	Decreases the value by 1.
G#2	Resets the value to the default setting (appropriate for the current Voice)
A2	Increases the value by 1.

# Recording Your Performance

You can record your keyboard performance as a User Song.

## NOTICE

- Note that the Recording operation replaces already recorded data with the newly recorded data, since only one User Song is available. Before recording, check whether a User Song exists or not by pressing the [▶/■] button. If it has already been recorded, it will be played back.

## Recording

1 Before recording, make important settings, such as Voice, Metronome, and Rhythm.

2 Press the [●] (Record) button to enable Record Ready mode.

To exit from Record Ready mode, press the [●] button again.

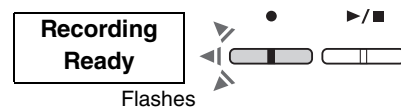

### NOTE

- You cannot enable Record Ready mode while a Song (page 23) is playing.
- You can use the Metronome while recording; however, the Metronome sound will not be recorded.

3 Play the keyboard or press the [▶/■] (Play/Stop) button to start recording.

You can also start recording also by pressing the [RHYTHM] button.

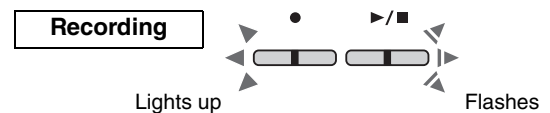

4 Press either the [●] or [▶/■] button to stop recording.

## NOTICE

- Never turn off the power while the recorded data is being stored (while the lamps are flashing). Otherwise, all recorded data will be lost.

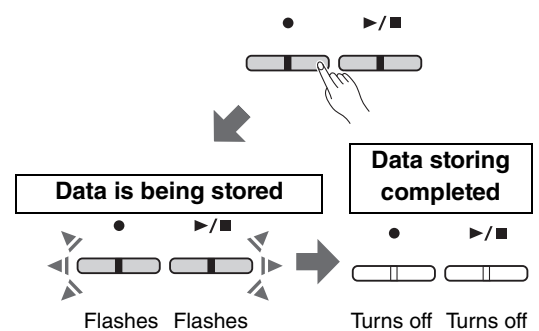

### Recording a keyboard performance with Split or Duo

If Split (page 15) or Duo (page 18) is on, the performance data will be recorded to each of L and R parts as follows:

- Performance via the Left hand (in Split) or Left player (in Duo): L part
- Performance via the Right hand (in Split) or Right player (in Duo): R part

5 To hear the recorded Song, press the [▶/■] button to start playback.

Press the [▶/■] button again to stop playback.



## Recording Independently to Two Parts

You can record your performance to either Right part (R) or Left part (L) separately.

### NOTE

- In Split (page 15) or Duo (page 18), use the normal Recording method (page 36) because the Recording method here cannot be used.
- Rhythm (page 26) can be recorded only when both L/R parts are empty. If you want to record a Rhythm, make sure to record first to a blank Song.

**1 Before recording, make the settings such as Voice, Metronome, or Rhythm.**

**2 While holding down the [●] button, press the [R] or [L] button for the part you want to record, to enable Record Ready mode.**

To exit the Record Ready mode, press the [●] button again.

### NOTICE

- If also the [▶/■] button also flashes, performance data is already recorded to either part. To avoid accidental overwriting, check whether data has been recorded by playing back each Part (page 25).

#### If data has already been recorded to the other Part:

The data in this Part will be played back while recording, enabling you to record your performance along with the playback sound. To turn the Part off or on, hold down the [▶/■] button and press the appropriate Part button.

**3 Play the keyboard or press the [▶/■] button to start recording.**

### NOTE

- You can use the Metronome while recording; however, the Metronome sound will not be recorded.

**4 Press either the [●] or [▶/■] to stop recording.**

### NOTICE

- Never turn off the power while the recorded data is being stored (while the lamps are flashing). Otherwise, all recorded data will be lost.

**5 If desired, record the other part by repeating Steps 1–4.**

**6 To hear the recorded Song, Press [▶/■] to start playback.**

Press the [▶/■] button again to stop playback.

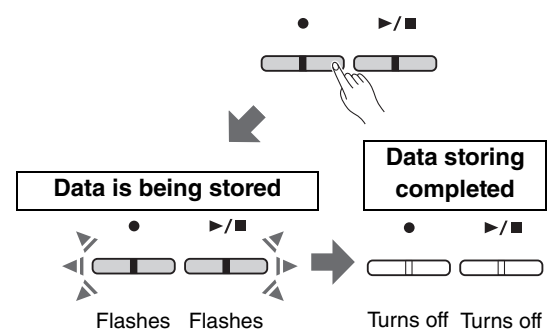
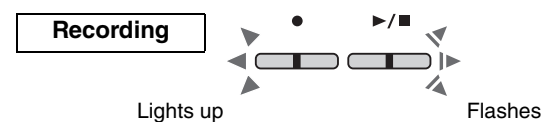
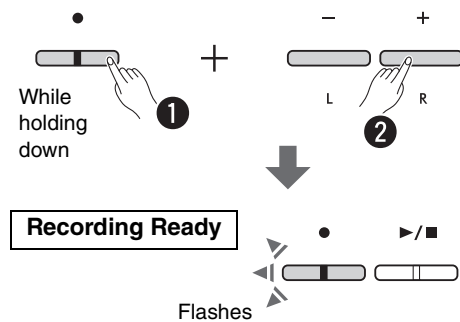

If you want to re-record either part, execute the above operations from step 1.

## Deleting the entire User Song

- 1 While holding down the [●] button, press the [DEMO/SONG] button.

To exit from this status, press the [●] button.

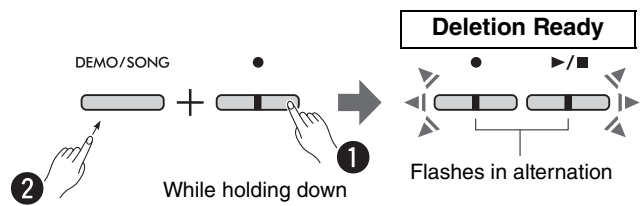

- 2 Press the [▶/■] button to delete the data of the entire Song.

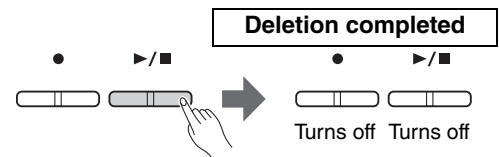

## Deleting a specific Part of the User Song

This operation overwrite-records silence for the Part you want to delete.

**NOTE**

- Rhythm cannot be deleted with this operation.

### 1 While holding down [●] button, press the [L] or [R] button to enable the Record Ready mode.

The [●] lamp will flash.

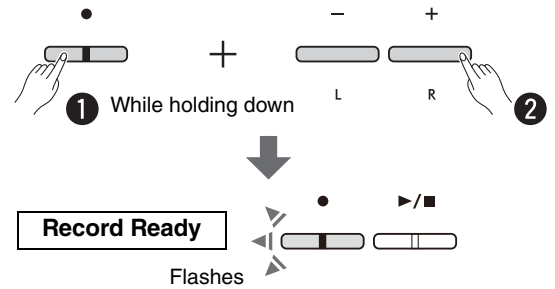

### 2 Press the [▶/■] button to start recording without playing the keyboard.

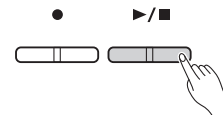

### 3 Press the [●] or [▶/■] button to stop recording.

No matter when you press the button (after step 2), all data recorded to the selected Part will be deleted. When deletion is complete, the lamp turns off.

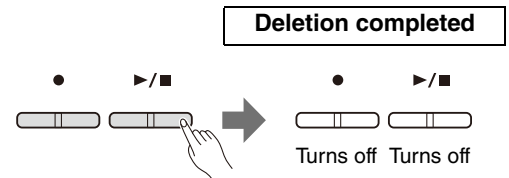

## Changing the Initial Settings of the Recorded Song

The following parameter settings of the Song can be changed after the Record operation is completed.

### For individual parts:

Voice (page 13), Volume Balance (pages 16,17,19), Reverb Depth (page 35)

### For the entire Song:

Tempo (page 21), Reverb Type (page 35)

## 1 Make settings for the above parameters, as desired.

## 2 While holding down the [●] button, press the desired Part button to engage Record Ready mode.

If you want to change the value of the parameters shared by two parts, select either part.

The [●] lamp will flash.

### NOTICE

- In this status, do not press the [▶/■] button or any key. Otherwise, recording starts and the already recorded data will be deleted.

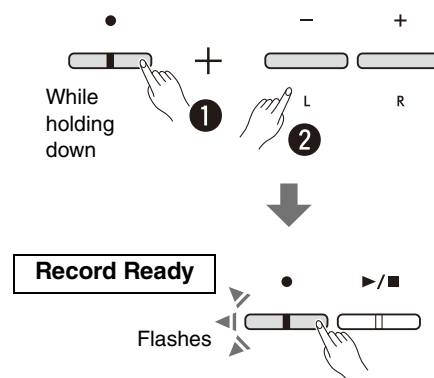

## 3 While holding down the [●] button, press the [▶/■] button to change the initial settings and to exit from Record Ready mode.

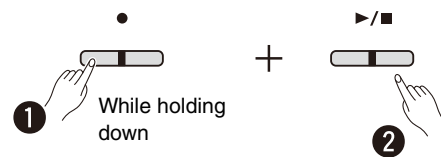

# Connecting Other Equipment

## ⚠ CAUTION

- Before connecting the instrument to other electronic components, turn off the power to all the components. Before turning the power on or off to all components, set all volume levels to minimum (0). Otherwise, electrical shock or damage to the components may result.

## Using Headphones

Since this instrument is equipped with two [PHONES] jacks, you can connect two pairs of headphones. If you are using only one pair, insert the plug into either of these jacks.

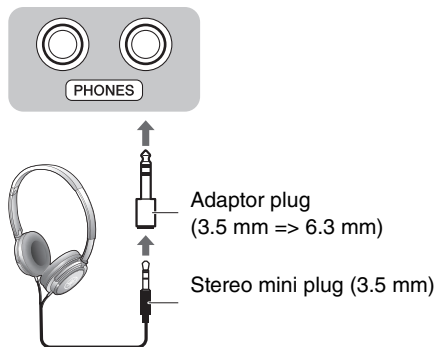

## ⚠ CAUTION

- Do not use the headphones for a long period of time at a high or uncomfortable volume level, since this can cause permanent hearing loss.

## Reproducing natural sound distance (Stereophonic Optimizer)

The Stereophonic Optimizer recreates for headphones a natural distance between your ears and the instrument, just as when playing an acoustic piano. This affects the sound of the connected headphones when the Piano Voice (page 13) is selected. To turn this function on or off, simultaneously hold down the [PIANO] button and press the F3 key (off) or F#3 key (on).

**Default setting: on**

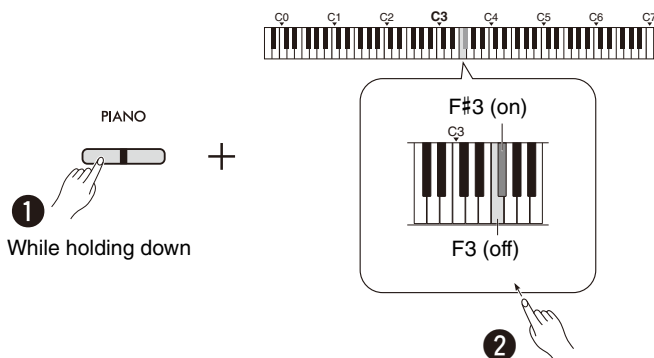

## NOTE

- The Stereophonic Optimizer function has no effect when the Built-in speaker parameter (page 45) is set to on. When you are monitoring the sound output from the AUX OUT jacks (page 44) via headphones connected to the instrument, we recommend that you set the Stereophonic Optimizer function to off.

## Using the Included Footswitch or Separately Sold Pedal Unit

### Using the Footswitch (Sustain)

You can produce a natural sustain as you play by pressing the included footswitch plugged into the [SUSTAIN] jack (page 6). You can also connect and use the separately sold FC3A foot pedal, which is equipped with the Half-pedal function\*, or an FC4A or FC5 footswitch.

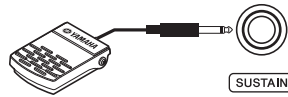

#### NOTE

- Make sure that power is off when connecting or disconnecting the footswitch or foot pedal.
- Do not press the footswitch or foot pedal when turning the power on. Doing this changes the recognized polarity of the controller, resulting in reversed operation.

#### \* Half-pedal function

This function allows you to vary the sustain length depending on how far the pedal is pressed. The farther down you press the pedal, the more the sound sustains. For example, if you press the damper pedal and all notes you are playing sound a bit murky and loud with too much sustain, you can release the pedal half way or higher to decrease the sustain (murkiness).

## Using the Separately Sold Pedal Unit

The [PEDAL UNIT] jack is for connection to the separately sold pedal units: LP-1 (for P-225) and LP-5A (for P-223) which are equipped with the Half Pedal function (page 42).

**NOTE**

- Make sure that power is off when connecting or disconnecting the pedal unit.

Make sure to assemble the unit on a separately sold Keyboard Stand (L-200 or L-100).

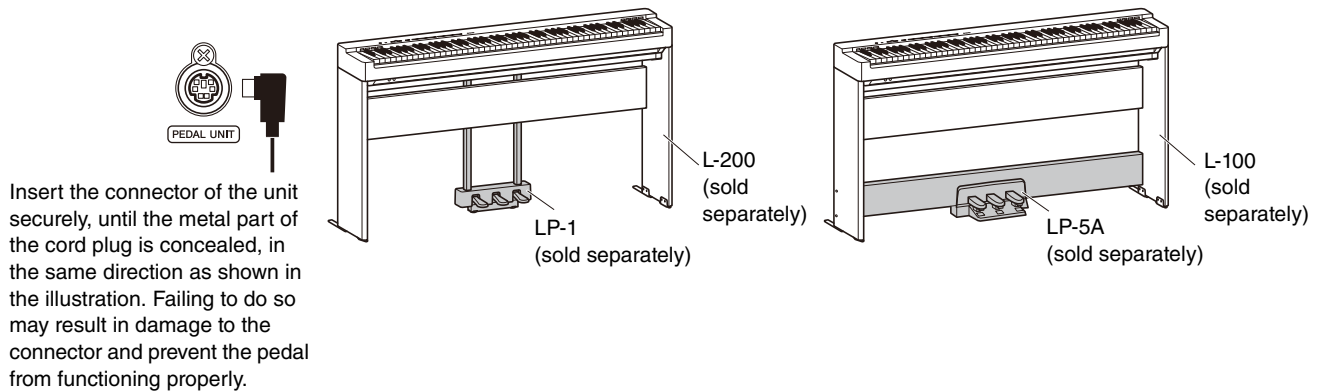

### Pedal functions

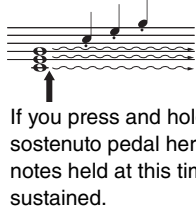
<p>Damper pedal (Right pedal)</p>	<p>Pressing this pedal will sustain notes longer. Releasing this pedal immediately stops (damps) any sustained notes. A Half-pedal function (page 42) of this pedal creates partial sustain effects, depending on how far down you press the pedal.</p>
<p>Sostenuto pedal (Center pedal)</p>	<p>If you press the sostenuto pedal while the note(s) are held, those notes will be sustained even after released as long as you hold the pedal (as if the damper pedal had been pressed) but all subsequently played notes will not be sustained. This makes it possible to sustain a chord, for example, while other notes are played "staccato."</p> <div style="text-align: right;">  </div>
<p>Soft pedal (Left pedal)</p>	<p>The soft pedal reduces the volume and slightly changes the timbre of notes played while the pedal is pressed. The soft pedal will not affect notes that are already playing when it is pressed.</p> <p><b>NOTE</b></p> <ul style="list-style-type: none"> <li>• When the "Jazz Organ" is selected, pressing and releasing this pedal switches between "fast" and "slow" of the Rotary Speaker speed. When the "Vibraphone" is selected, this pedal switches Vibrato on and off.</li> </ul>

### Pedal function in Duo (page 18)

- Damper Pedal: Applies Sustain to the right player area.
- Sostenuto Pedal: Applies Sustain to both player areas.
- Soft Pedal: Applies Sustain to the left player area.

## Connecting External Speakers

By connecting to powered speakers or other audio equipment, you can play this instrument at higher volumes. Refer to the diagram below and use audio cables for connection.

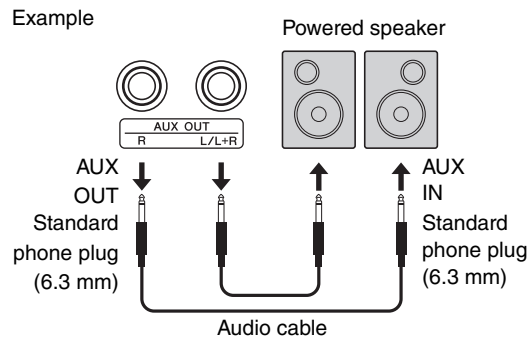

### NOTICE

- To avoid possible damage, first turn on the power to the instrument, and then to the external device. When turning off the power, do in reverse: first turn off the power to the external device, and then to the instrument.

### NOTE

- Use audio cables and adaptor plugs having no (zero) resistance.
- When connecting a mono device, use only the [L/L+R] jack.
- When you are monitoring the sound output via the AUX OUT jacks by using headphones connected to the instrument, we recommend that you set the Stereophonic Optimizer function (page 41) to off.

## Adjusting the volume of the External speakers

You can select how the volume of audio output via the AUX OUT jack is controlled. While holding down the [METRONOME] and [RHYTHM] buttons simultaneously, press the A5 key to set to “Variable,” or press the A#5 key to set to “Fixed.”

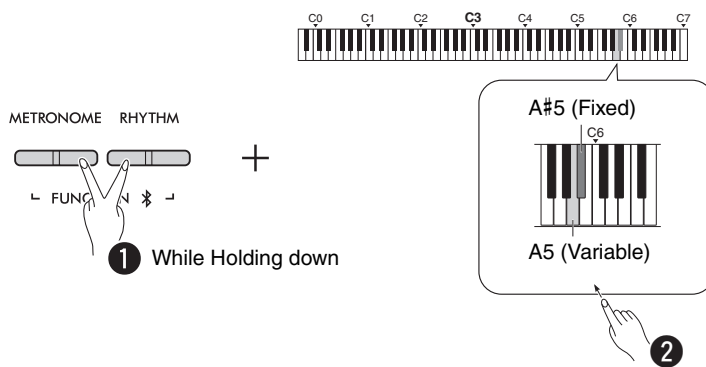

**Default setting:** Variable

Key	Setting	Descriptions
A5	Variable	Operating the [VOLUME] slider will affect the sound volume of the external speaker, making it the same level as that of the instrument's speaker.
A#5	Fixed	Operating the [VOLUME] slider will not affect the sound volume of the external speaker and headphones.

## Setting the Built-in Speaker to On/Off

You can set whether the sound of this instrument is always output from its built-in speaker (page 5) or not. While holding down the [METRONOME] and [RHYTHM] buttons simultaneously, press one of the keys: F5 key (off), F#5 (on), or G5 (auto).

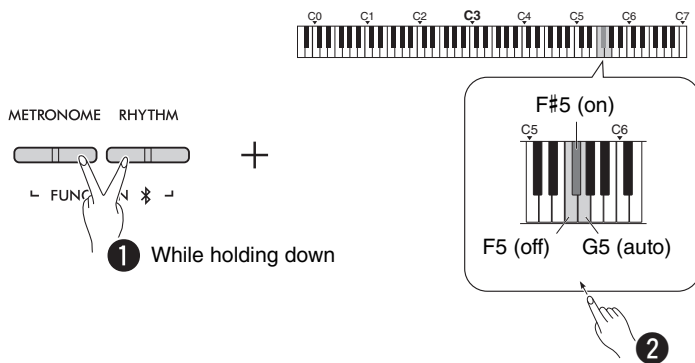

**Default setting:** Auto

Key	Setting	Descriptions
F5	off	No sound will be output from the built-in speakers regardless of the connection status. This setting is useful when you want to output the sound only from external speaker.
F#5	on	Sound of this instrument will be output from the built-in speakers regardless of the connection status. This setting avoids damage to the [PHONES] jack (page 4), since the headphones need not to be plugged or unplugged repeatedly in places like music classrooms.
G5	auto	The sound output from the built-in speakers will be disabled only when headphones are connected.

## Connecting to a Computer or Smart Device

When a computer or a smart device (smartphone, tablet, etc.) is connected to the [USB TO HOST] terminal of this instrument, both MIDI and audio data can be communicated between the devices.

For details on how to connect with a computer, refer to "Computer-related operations" on the Yamaha website (page 2). For details on using the smart device apps by connecting with a smart device, refer to page 48.

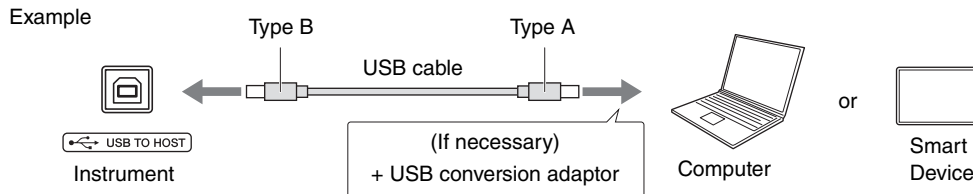

### ⚠ CAUTION

- If you are using a DAW (digital audio workstation) with this instrument, set the Audio Loopback (page 47) to off. Otherwise, a loud sound may occur, depending on the settings of the computer or the application software.

### NOTICE

- Use an AB type USB cable of less than 3 meters. USB 3.0 cables cannot be used.

### NOTE

- When connecting this instrument to a computer equipped with the USB type C terminal, prepare a USB conversion adaptor compatible with the computer.
- When using a USB cable to connect the instrument to your computer, make the connection directly without passing through a USB hub.
- For information about making the MIDI settings on your computer and/or software, refer to the relevant documentation.

## Playback/Recording of Audio Data (as USB audio interface)

Audio data on a smart device or a computer can be played back on this instrument. You can also record your keyboard performance as audio data to a music production app on a smart device or a computer.

### NOTE

- When using a Windows computer, you will need to install the Yamaha Steinberg USB Driver to your computer. For details, refer to the "Computer-related Operations" on Yamaha website (page 2).

## Audio Loopback

You can set whether audio sound input from a computer/smart device via the [USB TO HOST] terminal is returned to the same device or not (whether Audio Loopback is on or off) along with the audio sound of your keyboard performance.

While holding down the [METRONOME] and [RHYTHM] buttons simultaneously, press the C6 key (Off) or C#6 (On).

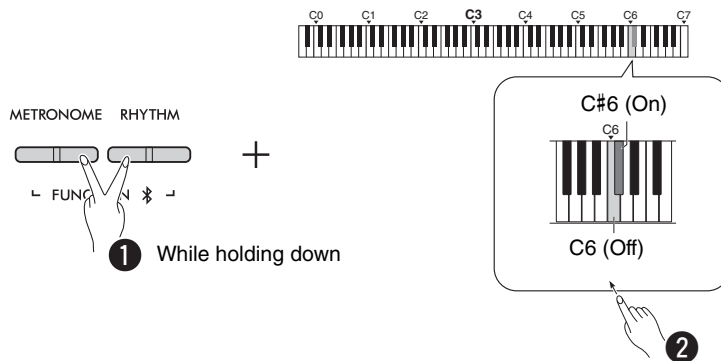

**Default setting:** On

Key	Settings	Descriptions
C6	Off	Audio sound input from a computer/smart device via the [USB TO HOST] terminal is NOT returned to the same device. If you intend to record only the sound played on the instrument, set this to "Off."
C#6	On	Audio sound input from a computer/smart device via the [USB TO HOST] terminal is returned to the same device. If you want to record the audio input sound as well as the sound played on the instrument, set this to "On."

## Using Smart Device Apps

By connecting this instrument to a smart device, you can use convenient and powerful apps described below to get even more enjoyable musical use from it.

For details on these apps or compatible smart devices, access the web pages of the respective apps on the following page:

<https://www.yamaha.com/2/apps/>



### Smart Pianist

Smart Pianist (free download) lets you make various setting of the instrument intuitively while viewing the screen.

For information on how to connect the instrument to a smart device and how to use the app, see the Smart Pianist User Guide.

Smart Pianist User Guide

<https://manual.yamaha.com/mi/app/smartpianist/>



#### NOTICE

- Activating the Smart Pianist app while the instrument is connected to the smart device overwrites the settings on the instrument by those of Smart Pianist.

### Rec 'n' Share

Rec 'n' Share allows you to record your performances on this instrument, edit them and even make videos of them, and then share them with people around the world. To connect the instrument to a smart device, you need a USB cable (Type A – Type B) and a conversion adaptor that matches the connector of the smart device.

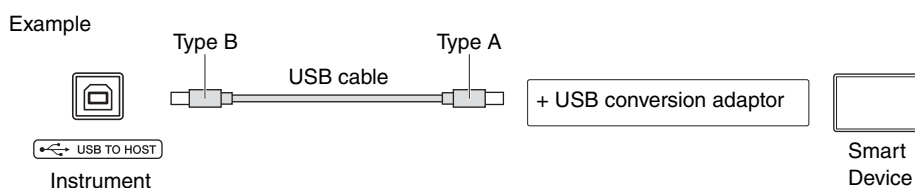

## Listening to Audio playback of the Bluetooth device on this Instrument

**Before using the Bluetooth function, be sure to read “About Bluetooth” on page 50.**

You can play the sound of audio data saved in a Bluetooth-equipped device, such as a smartphone or portable audio player, on this instrument and listen to it through the built-in speakers of the instrument.

### NOTE

- This instrument cannot transmit audio data to Bluetooth-equipped devices via Bluetooth.
- Bluetooth headphones or Bluetooth speakers cannot be connected or used with this instrument.
- Smart device apps such as Smart Pianist cannot be used via the Bluetooth Audio function described here.

### 1 Hold down the [METRONOME] and [RHYTHM] buttons simultaneously for three second or longer to pair with a Bluetooth-equipped device (Pairing\*).

\*Pairing: Refers to registering this instrument on a Bluetooth-equipped device to establish mutual recognition for wireless communication between the two.

If you wish to connect your Bluetooth-equipped device to the instrument, the device needs to be paired with the instrument first. Once the device has been paired with this instrument, there is no need to perform pairing again. To cancel the pairing, press any button.

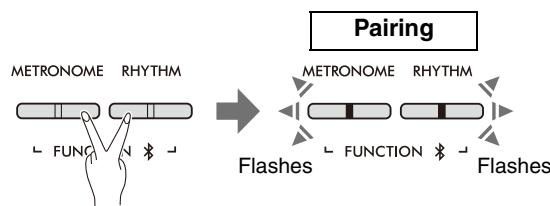

### NOTE

- Only one Bluetooth-equipped device can be connected to this instrument at a time (although up to 8 devices can be paired to this instrument). When pairing with the 9th device has succeeded, pairing data for the device with the oldest connection date will be deleted.

### 2 On the Bluetooth-equipped device, set the Bluetooth function to on and select the instrument “P-225 AUDIO” or “P-223 AUDIO” from the connection list.

Make sure to complete this operation while the [METRONOME] and [RHYTHM] buttons are flashing.

### NOTE

- If you are prompted to enter a passkey, enter the numerals “0000.”

### 3 Play back audio data on the Bluetooth-equipped device to confirm that the built-in speakers of the instrument can output the audio sound.

When you turn on the instrument the next time, the last-connected Bluetooth-equipped device will be connected to this instrument automatically, if the Bluetooth function of the Bluetooth-equipped device and the instrument is set to on. If it is not connected automatically, select the model name of the instrument from the connection list on the Bluetooth-equipped device.

## Switching the Bluetooth Function On/Off

By default, the Bluetooth function will be on right after turning the instrument's power on, however you can set the function to off.

While holding down the [METRONOME] and [RHYTHM] buttons simultaneously, press the F1 key (Off) or F#1 (On).

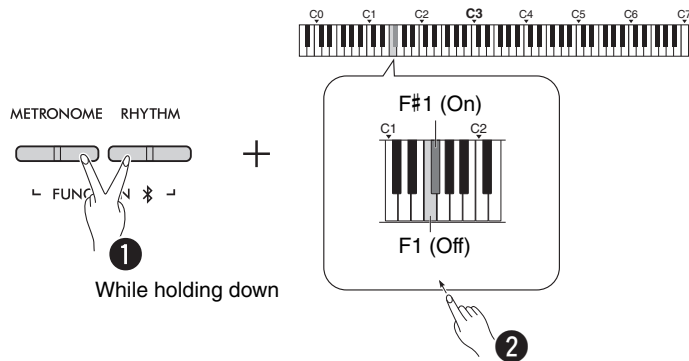

### ■ About Bluetooth

Bluetooth is a technology for wireless communication between devices within an area of about 10 meters (33 ft.) employing the 2.4 GHz frequency band.

Handling Bluetooth communications

- The 2.4 GHz band used by Bluetooth compatible devices is a radio band shared by many types of equipment. While Bluetooth compatible devices use a technology minimizing the influence of other components using the same radio band, such influence may reduce the speed or distance of communications and in some cases interrupt communications.
- The speed of signal transfer and the distance at which communication is possible differs according to the distance between the communicating devices, the presence of obstacles, radio wave conditions and the type of equipment.
- Yamaha does not guarantee all wireless connections between this unit and devices compatible with Bluetooth function.

### Bluetooth capability

Depending on the country in which you purchased the product, the instrument may not have Bluetooth capability. If the Bluetooth logo is printed on the control panel, this means that the product is equipped with Bluetooth functionality.

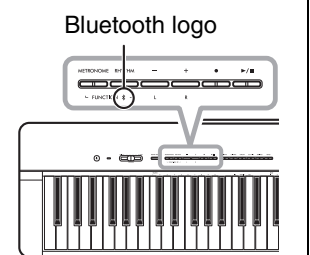

# MIDI Functions

You can make detailed adjustments to MIDI settings.

**NOTE**

- For instructions on how to connect this instrument to a computer, refer to page 46 or the “Computer-related Operations” downloadable from the Yamaha Downloads website (page 2).

## MIDI Transmit/Receive Channel Selection

In any MIDI control setup, the MIDI channels of the transmitting and receiving devices must be matched for proper data transfer. This instrument enables you to specify the channel on which the instrument transmits or receives MIDI data.

### Setting the Transmit Channel

While simultaneously holding down the [METRONOME] and [RHYTHM] buttons, press one of the D4–F4 keys.

**Default setting:** 1

### Setting the Receive Channel

While simultaneously holding down the [METRONOME] and [RHYTHM] buttons, press one of the G4–B4 keys.

**Default setting:** ALL

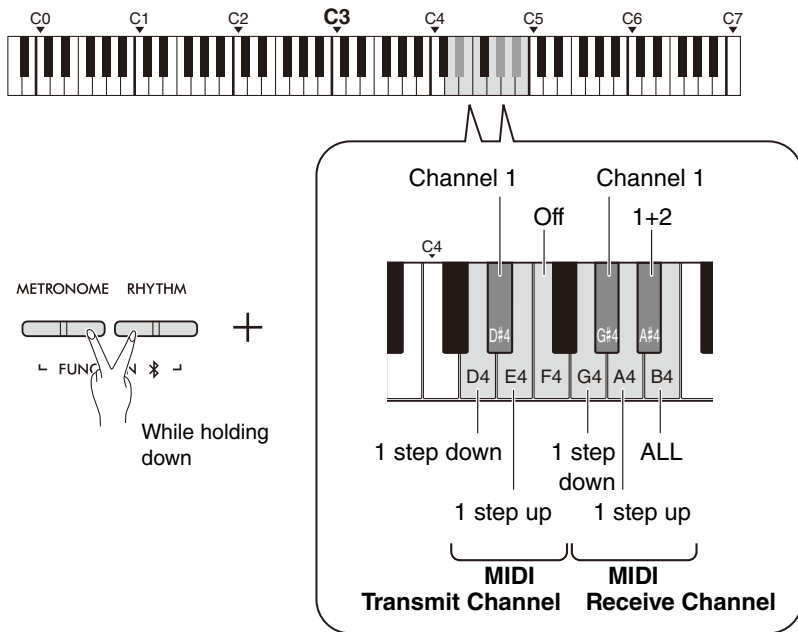

### MIDI transmit channels in Dual, Split or Duo

Voice 1 data is transmitted on its specified channel and Voice 2 data is transmitted on the next greater channel number relative to the specified channel. Note that no data is transmitted if the transmit channel is set to "Off."

### When the Receive Channel is set to "ALL":

The instrument works as a "Multi-timbre" tone generator which can receive MIDI messages of over all 16 MIDI channels simultaneously. This means that the instrument can play back multi-channel song data transmitted from a computer.

### When the Receive Channel is set to "1+2":

This instrument can receive MIDI messages over channels 1 and 2 only. This means that the instrument plays back only keyboard performance data of the entire Song transmitted from a computer.

**NOTE**

- Program change and other like channel messages received will not affect the panel settings of the instrument or the notes you play on the keyboard.
- Data for the Demo Songs and Preset Songs cannot be transmitted via MIDI.

## Local Control On/Off

“Local Control” refers to the fact that, normally, the keyboard of the instrument controls its internal tone generator, allowing the internal Voices to be played directly from the keyboard. This situation is “Local Control On,” since the internal tone generator is controlled locally by its own keyboard. Local control can be turned OFF, however, so that the keyboard of the instrument does not play the internal Voices, but the appropriate MIDI information is still transmitted via the [USB TO HOST] terminal when notes are played on the keyboard. At the same time, the internal tone generator responds to MIDI information received via the [USB TO HOST] terminal.

While simultaneously holding down the [METRONOME] and [RHYTHM] buttons, press the B3 key. Pressing the B3 key repeatedly toggles between Local Control On and Off.

**Default setting:** On

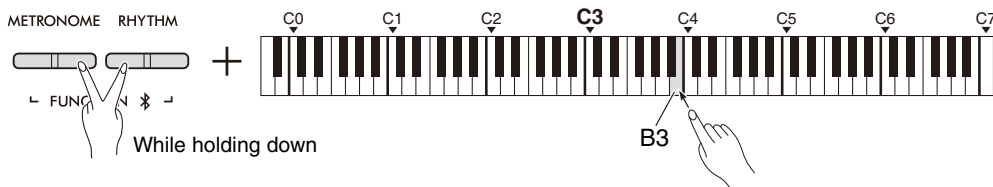

## Program Change On/Off

Normally the instrument will respond to MIDI program change numbers received from a computer, causing the same numbered Voice to be selected on the corresponding channel (the keyboard Voice does not change). The instrument will normally also send a MIDI program change number whenever one of its Voices is selected, causing the same numbered Voice or program to be selected on the computer if the computer is set up to receive and respond to MIDI program change numbers.

This instrument lets you cancel program change number reception and transmission so that Voices can be selected on the instrument without affecting the computer, and vice versa.

While simultaneously holding down the [METRONOME] and [RHYTHM] buttons, press the C4 key. Pressing the C4 key repeatedly toggles between Program Change On and Off.

### **NOTE**

- For information on program change numbers for each of the Voices of the instrument, refer to “Preset Voice List” on page 55.

**Default setting: On**

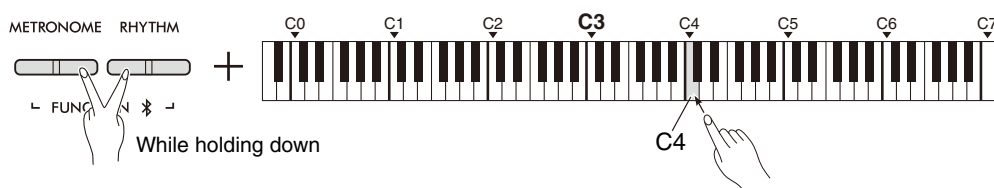

## Control Change On/Off

Normally the instrument will respond to MIDI control change data On from a computer, causing the Voice on the corresponding channel to be affected by pedal and other “control” settings received from the controlling device (the keyboard Voice is not affected). The instrument also transmits MIDI control change information when the pedal or other appropriate controls are operated.

This instrument lets you cancel control change data reception and transmission so that, for example, the pedal of the instrument and other controls can be operated without affecting a computer, and vice versa.

While simultaneously holding down the [METRONOME] and [RHYTHM] buttons, press the C#4 key. Pressing the C#4 key repeatedly toggles between Control Change On and Off.

### NOTE

- For information on control changes that can be used with the instrument, refer to “MIDI Implementation Chart” on page 57.

**Default setting: On**

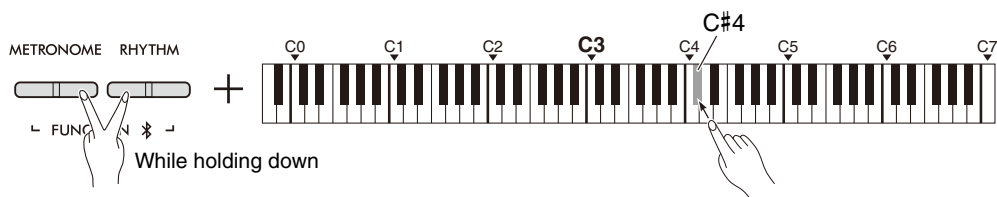

## Preset Voice List

Program change numbers are often specified as numbers “0–127.” Since this list uses a “1–128” numbering system, in such cases it is necessary to subtract 1 from the transmitted program change numbers to select the appropriate sound: e.g. to select Live Grand in the list below, transmit program change number 1.

Voice Button	Voice Name	MSB (0–127)	LSB (0–127)	Program Change # (1–128)
PIANO	Grand Piano	108	0	1
	Live Grand	108	2	2
	Ballad Grand	108	3	1
	Bright Grand	108	0	2
E.PIANO	Stage E.Piano	108	0	5
	DX E.Piano	108	0	6
	Vintage E.Piano	108	1	5
	Synth Piano	108	0	89
ORGAN	Jazz Organ	108	0	17
	Rock Organ	108	0	19
	Organ Principal	108	1	20
	Organ Tutti	108	0	20
[P-225] CLV./VIB.	E.Clavichord	108	0	8
	Vibraphone	108	0	12
	Harpsichord 8'	108	0	7
	Harpsi.8'+4'	108	1	7
[P-223] STRINGS	Strings	108	0	49
	Slow Strings	108	0	50
	Choir	108	0	53
	Synth Pad	108	0	90
[P-225] STRINGS	Strings	108	0	49
	Slow Strings	108	0	50
	Choir	108	0	53
	Synth Pad	108	0	90
[P-223] OTHERS	Harpsichord 8'	108	0	7
	Harpsi.8'+4'	108	1	7
	Accordion	108	0	22
	Gu Zheng	108	115	108
[+BASS]	Acoustic Bass	108	0	33
	Electric Bass	108	0	34
	Bass & Cymbal	108	1	33
	Fretless Bass	108	0	36

## Effect Type List

### Reverb Type List

Effect Name	Decimal		Hex	
	MSB	LSB	MSB	LSB
Off	0	0	0H	0H
Recital Hall	1	24	1H	18H
Concert Hall	1	4	1H	4H
Chamber	2	24	2H	18H
Club	3	24	3H	18H

## MIDI Implementation Chart

YAMAHA [ Digital Piano ]

Model P-225, P-223

MIDI Implementation Chart

Version:1.0

Function...	Transmitted	Recognized	Remarks
Basic Default Channel Changed	1 o	1 - 16 o	
Mode Default Messages Altered	3 x *****	3 x x	
Note Number : True voice	0 - 127 *****	0 - 127 0 - 127	
Velocity Note ON Note OFF	o 9nH,v=1-127 o 8nH,v=64	o 9nH,v=1-127 o 9nH,v=0 or 8nH	
After Key's Touch Ch's	x x	x o	
Pitch Bend	o	o 0 - 24 semi	*1
Control Change	0,32 o 1,5,11 x *2 7,10 o 19 x *2 6,38 x *2 64,66,67 o 65 x *2 71-74 x *2 84 x *2 88 x *2 91,93 o 96-97 x *2 98-99 x *2 100-101 o	o o o x o o o o x o o o o o o	Bank Select  Key Acceleration Data Entry Pedal Portamento Sound Controller  High-Res Velocity Prefix Effect Depth RPN Inc,Dec NRPN LSB,MSB RPN LSB,MSB
Prog Change : True #	o 0 - 127 *****	o 0 - 127 0,1,4,5,6,11,16,19,48	
System Exclusive	o	o	
: Song Pos. Common : Song Sel. : Tune	x x x	x x x	
System : Clock Real Time: Commands	o o	x o	
Aux :All Sound OFF :Reset All Cntrls :Local ON/OFF Mes- :All Notes OFF sages:Active Sense :Reset	x x x x o x	o (120,126,127) o (121) o (122) o (123-125) o x	
Notes:	*1 For some Voices (such as Piano or Harpsichord Voices), the pitch may not be changed according to the pitch bend setting range. *2 These Control Change messages cannot be transmitted by panel operations, but can be transmitted by Song/Rhythm playback data.		

Mode 1 : OMNI ON , POLY

Mode 2 : OMNI ON , MONO

o : Yes

Mode 3 : OMNI OFF, POLY

Mode 4 : OMNI OFF, MONO

x : No

# Troubleshooting

Problem	Possible Cause and Solution
When the instrument is turned on or off, a popping sound is temporarily produced.	This is normal and indicates that the instrument is receiving electrical power.
The instrument does not turn on.	The instrument has not been plugged in properly. Securely connect the AC adaptor to the DC IN jack on the instrument and to the AC outlet (page 7).
The instrument is automatically turned off even if no operation is done.	This occurs due to the Auto Power Off function (page 8). If necessary, disable the Auto Power Off function.
Noise is heard from the speakers or headphones.	The noise may be due to interference caused by the use of a mobile phone in close proximity to the instrument. Turn off the mobile phone, or use it further away from the instrument.
Noise is heard from the instrument's speakers or headphones when using the instrument with your smart device, such as smartphone or tablet.	When you use the instrument along with your smart device, we recommend that you set that device's "Airplane Mode" to on in order to avoid noise caused by communication.
The overall volume is low, or no sound is heard.	The instrument's speakers are turned off. Turn them back on (page 45).
	Make sure a pair of headphones or conversion adaptor is not connected to the headphones jack (page 4).
	Make sure that Local Control is set to on (page 52).
Moving the [VOLUME] slider does not change the volume of the headphones.	Have you set the external speaker volume to "Fixed"? Change the external speaker volume to "Variable" (page 44).
The pedal has no effect.	The pedal cable/plug may not be properly connected. Make sure to securely insert the pedal plug into the [SUSTAIN] or [PEDAL UNIT] jack (page 6).
The footswitch (for sustain) seems to produce the opposite effect. For example, pressing the footswitch cuts off the sound and releasing it sustains the sounds.	The polarity of the footswitch (page 42) is reversed because the footswitch was pressed when the power was turned on. Turn off the power and turn it on again to reset the function. Make sure to not press the footswitch when turning the power on.
The Bluetooth-equipped device cannot be paired with nor connected to the instrument.	Check the Bluetooth function of the Bluetooth-equipped device is activated (page 50). To connect the Bluetooth-equipped device and the instrument, the Bluetooth function of both devices must be turned on.
	The Bluetooth-equipped device and the instrument need to be paired to connect each other via Bluetooth (page 49).
	In case there is a nearby device (microwave oven, wireless LAN device, etc.) that outputs signals in the 2.4 GHz frequency band nearby, move this instrument away from the device that is emitting radio-frequency signals.
When using a DAW (Digital Audio Workstation) with the instrument, there is a loud noise or abnormal sound.	Depending on the settings of the computer or the application software, a loud sound may occur. Set the Audio Loopback function off (page 47).

# Index

## Numerics

50 Classics.....	23
50 Preset Songs.....	23

## A

Audio Loopback.....	47
Auto Power Off.....	8

## B

Backup.....	11
Bass.....	28
Beat.....	22
Bluetooth.....	49
Built-in Speaker.....	45

## C

Computer.....	46
Computer-related operations.....	2
Control Change.....	54

## D

Damper pedal.....	43
Demo Song.....	20
Demo Song List.....	20
Dual.....	17
Duo.....	18
Duo Type.....	19
Duo Type List.....	19

## E

Ending.....	28
External Speaker.....	44

## F

Footswitch.....	42
-----------------	----

## H

Half-pedal.....	42
Headphone.....	41

## I

Initializing.....	11
Intelligent Acoustic Control (IAC).....	9
Intro.....	28

## L

Local Control.....	52
--------------------	----

## M

Metronome.....	21
Metronome Tempo.....	21, 22

Metronome Volume.....	22
MIDI.....	51
MIDI Implementation Chart.....	57
Mute (Part).....	25

## O

Octave.....	16, 17, 18
Operation Confirmation Sounds.....	10
Owner's Manual.....	2

## P

Pairing.....	49
Part (Recording).....	37, 39
Part (Song).....	25
Pedal.....	42, 43
Pedal Unit.....	43
Playback (50 Preset Songs).....	23
Playback (Audio data).....	46
Playback (Demo Song).....	20
Power.....	7
Program Change.....	53

## Q

Quick Operation Guide.....	2
Quick Play.....	23

## R

Rec 'n' Share.....	48
Receive Channel.....	51
Recording.....	36
Recording (Audio data).....	46
Repeat.....	24
Reverb.....	35
Reverb depth.....	35
Reverb Type List.....	35
Rhythm.....	26
Rhythm List.....	27
Rhythm Tempo.....	26, 28
Rhythm Volume.....	28

## S

Smart Device.....	46
Smart Device Connection Manual.....	2
Smart Pianist.....	48
Smart Pianist User Guide.....	2
Soft pedal.....	43

Song .....	23
Sostenuto pedal .....	43
Sound Boost .....	29
Sound Boost Type List .....	29
Split .....	15
Split Point .....	15
Stereophonic Optimizer .....	41
Sustain .....	42
<b>T</b>	
Tempo (Metronome) .....	21, 22
Tempo (Rhythm) .....	26
Tempo (Song) .....	24
Touch Sensitivity .....	33
Touch Sensitivity List .....	33
Transmit Channel .....	51
Transpose .....	30
Tuning .....	31
<b>U</b>	
USB audio interface .....	46
User Song .....	36, 38
<b>V</b>	
Version .....	12
Voice .....	13
Voice List .....	13
Volume (Metronome) .....	22
Volume (Rhythm) .....	28
Volume balance .....	16, 17, 19
VRM Lite .....	34
<b>W</b>	
Wall EQ .....	32