

Contents

Additional Explanation	2	Creating an Original Scale (USER SCALE)	31
Panel Descriptions	2	Setting a User Scale	31
Patch Mode	2	Recalling a User Scale	31
Performance Mode	2	System Settings	32
Key Touch	2	Procedure	32
Sample Import	2	System Parameters	32
Editing a Patch/Drum Kit	2	Connecting to a Computer via USB	35
Editing a Performance	2	Installing the USB Driver	35
Pattern Sequencer	3	Making USB Driver Settings	35
Realtime Erase	3	Using the JUNO-DS with DAW Software	36
Saving a Pattern As a "Performance" (SAVE AS PERFORM)	3	Using the JUNO-DS As a DAW Controller	36
Turning the Display Backlight On/Off	3	Using the JUNO-DS to Control DAW Software	36
Demo Songs	3	Assigning Functions to Knobs and Sliders	37
Patch Mode	4	Using the JUNO-DS As a MIDI Keyboard	37
Patch/Drum Kit Edit	4	Playing the JUNO-DS's Sound Generator from DAW Software ...	37
Procedure	4	Using the JUNO-DS As an Audio Interface	38
About the Parameters	4	Saving the DAW CONTROL Settings	38
Patch Parameters	4	Error Messages	39
Drum Kit Parameters	14	MFX/Chorus/Reverb Parameters	40
Effects Edit	17	MFX Parameters (MFX, MFX1-3)	40
Signal Flow	17	Chorus Parameters	58
Procedure	17	Reverb Parameters	58
Effects Parameters	18	Waveform List	59
Performance Mode	19	Patch List	66
Performance Edit	19	Performance List	76
Procedure	19	Drum Kit List	76
Performance Parameters	19	Drum Kit Assign List	77
Part Edit	21	Rhythm Pattern List	85
Procedure	21	Pattern List	86
Performance Parameters	21	Arpeggio Style List	86
Effects Edit	23	Vocoder/Auto Pitch List	86
Signal Flow	23	Placing This Unit on a Stand	87
Procedure	23		
Effects Parameters	24		
Sample Edit	25		
Procedure	25		
Sample Parameters	25		
Editing Arpeggios	29		
Selecting Ascending/Descending Variations (Motif)	29		
Editing the Vocoder/Auto Pitch	30		
Saving the Vocoder/Auto Pitch Settings (Write)	30		

Additional Explanation

Panel Descriptions

[NUMERIC] button	When this button is on (lit), you can use the [0]–[9] buttons to enter numeric values. * You can use this button only in the PATCH screen and PERFORM screen.
[ENTER] button	Used to execute an operation. List display You can move the cursor to a parameter and press the [ENTER] button to see a list of that parameter's values. You can select a value from the list that's shown. (Example) In the PATCH screen, move the cursor to the patch number and press the [ENTER] button to see the patch list. Press the [EXIT] button to return to the previous screen.

Patch Mode

- If you press the same category button in succession, the patch changes as follows each time you press the button.

Each time you press the button, the first patch of the two sub-categories is selected.
If a user patch is saved
Each time you press the button, the first patch of sub-category 1 → sub-category 2 → user → sub-category 1 ... is selected.

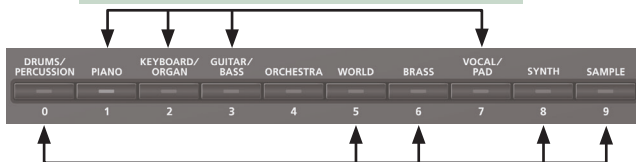

If a user patch is saved
Each time you press the button, the first patch of preset → user → preset ... is selected.

Performance Mode

- You can use pads [1]–[8] to select the applicable part (current part).
 - Pressing a pad [1]–[8] selects part 1–8.
 - Hold down the [SHIFT] button and press pad [1]–[8] to select part 9–16.

16-part mode

- Within Performance mode, the state in which neither split, dual, nor super layer is selected is called "16-part mode."

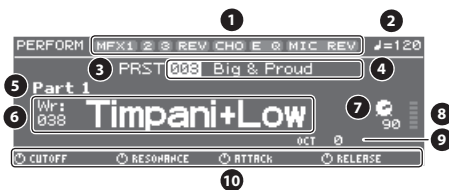

No.	Explanation	No.	Explanation
1	Effect on (lit)/off (unlit)	6	Category number/Patch name
2	Tempo	7	Level of the current part
3	Performance bank	8	Level meter
4	Performance number/name	9	Octave Shift setting
5	Current part	10	Parameters that can currently be adjusted by the control knobs

When you play the keyboard, you'll hear the current part and the parts whose keyboard switch (p. 19, p. 20, p. 22) is on.

Adjusting the volume

You can use the [UPPER] LEVEL slider and [LOWER] LEVEL slider to adjust the part 1 and part 2 volume (LEVEL).

Key Touch

- Depending on the KEY TOUCH setting, the [KEY TOUCH] button is lit or unlit.

Lit	When the Velocity setting is "REAL"
Unlit	When the Velocity setting is "1–127"

Sample Import

- When importing a sample, the OPTIMIZE window might appear depending on the user memory usage status.

OK	Memory is optimized, and then the sample import is executed.
CANCEL	Sample import is cancelled.

Editing a Patch/Drum Kit

PATCH EDIT

- In the PATCH EDIT screen when editing each tone, you can use pads [1]–[8] to perform the following operations.

Pads [5]–[8]	Turn each tone on (pad lit) or off. When a tone is on, a "✓" symbol appears.
Pads [1]–[4]	Make the pad(s) light to specify the tone(s) that you want to edit. You can also make multiple pads light to select multiple tones.

- In the PATCH EDIT screen, press the [MENU] button to open the INIT MENU window. Select "PATCH" or "TONE" and then press the [ENTER] button to initialize the selected patch or tone.

DRUM KIT EDIT

- A drum kit consists of a percussion instrument sound (tone) assigned to each key. The tone that's assigned to each key consists of a combination of up to four waves. Drum Kit Edit lets you edit the settings of the tone that's assigned to each key.
- In the DRUM KIT EDIT screen, when editing the four waves that make up the tone assigned to the selected key, you can use pads [1]–[8] to perform the following operations.

Pads [5]–[8]	Turn each wave on (pad lit) or off. When a wave is on, a "✓" symbol appears.
Pads [1]–[4]	Make the pad(s) light to specify the wave(s) that you want to edit. You can also make multiple pads light to select multiple waves.

- In the DRUM KIT EDIT screen, press the [MENU] button to open the INIT MENU window. Select "DRUM" or "TONE" and then press the [ENTER] button to initialize the selected drum kit or the tone of the selected key.

Editing a Performance

- "PERFORMANCE EDIT" lets you edit while viewing a list of the settings of all parts, and "PART EDIT" lets you edit each part of the performance individually.
 - * PERFORMANCE EDIT and PART EDIT have the same parameters in common.
- In the PERFORMANCE EDIT or PART EDIT screen, you can use pads [1]–[8] to select the part that you want to edit. If you hold down the [SHIFT] button and press a pad [1]–[8], a part 9–16 is selected.
- In the PERFORMANCE EDIT screen, press the [MENU] button to open the INIT MENU window. Select "PERFORM" or "PART" and press the [ENTER] button to initialize the selected performance or part.

Pattern Sequencer

- In the PATTERN SEQUENCER screen, you can long-press the [LOOP] button to open the LOOP window, where you can make loop-related settings. Press the [EXIT] button to close the LOOP window.

Parameter	Explanation
Loop Switch	Specifies whether playback will loop (ON) or not loop (OFF). * You can also switch this by pressing the [LOOP] button.
	OFF, ON
Loop Rec	Specifies whether to loop-record (ON) or not loop-record (OFF). * You can also switch this by pressing the [LOOP] button while holding down the [SHIFT] button.
	OFF, ON

- Use the [UPPER] slider to adjust the level of track 1, and the [LOWER] slider to adjust the level of track 2.
- Use the [PHRASE PAD] slider to increase or decrease the level that's specified for tracks 3–8 while maintaining the balance between these tracks.
- Press the [MIXER] button to open the MIXER screen. Here you can set the pan and level of each track.

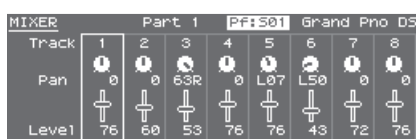

You can use pads [1]–[8] to select a track to edit. Use the [UPPER]/[LOWER]/[PHRASE PAD] sliders to adjust the level.

MEMO

Tracks 1–7 are assigned to parts 1–7, and track 8 is assigned to part 10.

Realtime Erase

Erasing only specified notes during recording or playback (REALTIME NOTE ERASE)

- During recording or playback, hold down the [RHYTHM PATTERN] button and press the [ERASE] button. The REALTIME NOTE ERASE window appears.
- Press a key on the keyboard to specify the note that you want to erase.
- Press the [ERASE] button. While you continue holding down the key, only the note you specify is erased from the selected track.

Erasing only movements of knobs or the bender/modulation lever during recording or playback

- During recording or playback, hold down the [MUTE] button and press the [ERASE] button. Only while you continue holding down these buttons, movements of the knobs and the bender/modulation lever are erased from the selected track.

Saving a Pattern As a "Performance" (SAVE AS PERFORM)

Settings related to the sound of the pattern (preset/user) used in the pattern sequencer can be saved as a performance. For example, if you want to export a pattern to SMF, use your DAW to edit it into a complete song, and then use the JUNO-DS to play this song data, the performance saved by the "SAVE AS PERFORM" function can be recalled to play the data using the original sound.

- In the PATTERN SEQUENCER screen, select a pattern.

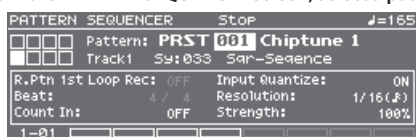

- Press the [MENU] button. The MENU screen appears.
- Move the cursor to "PATTERN UTILITY," and press the [ENTER] button.

- Move the cursor to "SAVE AS PERFORM," and press the [ENTER] button. The SAVE AS PERFORM screen appears.
- Use the value dial to select the write destination performance, and press the [ENTER] button. A confirmation message appears. If you decide to cancel, press the [EXIT] button.
- Move the cursor to "OK," and press the [ENTER] button. Writing is complete when the screen indicates "Completed!"

NOTE

Never turn off the power while the screen indicates "Writing...."

Turning the Display Backlight On/Off

To reduce battery consumption, you can turn off the display backlight when it's not required.

- Hold down the [SHIFT] button and press the [EXIT] button. The display backlight will turn off.

Turning the display backlight on

- Hold down the [SHIFT] button and press the [ENTER] button. The display backlight will turn on.

Demo Songs

1	Wonder	Copyright © 2015 Roland Corporation
2	There There There	

Patch Mode

Patch/Drum Kit Edit

Procedure

1. Select a patch or drum kit that you want to edit.
2. Press the [SAMPLE IMPORT] button and [DAW CONTROL] button simultaneously.
The EDIT MENU screen appears.
3. Move the cursor to "PATCH EDIT" or "DRUM KIT EDIT," and press the [ENTER] button.
The PATCH EDIT or DRUM KIT EDIT screen appears.

MEMO

- In the PATCH EDIT screen when editing each tone, you can use pads [1]–[8] to perform the following operations.

Pads [5]–[8]	Turn each tone on (pad lit) or off. When a tone is on, a "✓" symbol appears.
Pads [1]–[4]	Make the pad(s) light to specify the tone(s) that you want to edit. You can also make multiple pads light to select multiple tones.

- In the PATCH EDIT screen, press the [MENU] button to open the INIT MENU window. Select "PATCH" or "TONE" and then press the [ENTER] button to initialize the selected patch or tone.

MEMO

- In the DRUM KIT EDIT screen, when editing the four waves that make up the tone assigned to the selected key, you can use pads [1]–[8] to perform the following operations.

Pads [5]–[8]	Turn each wave on (pad lit) or off. When a wave is on, a "✓" symbol appears.
Pads [1]–[4]	Make the pad(s) light to specify the wave(s) that you want to edit. You can also make multiple pads light to select multiple waves.

- In the DRUM KIT EDIT screen, press the [MENU] button to open the INIT MENU window. Select "DRUM" or "TONE" and then press the [ENTER] button to initialize the selected drum kit or the tone of the selected key.

4. Move the cursor to tab, and use the [◀] [▶] buttons to switch the pages.
5. Move the cursor to the parameter that you want to edit, and use the value dial to change the value.
6. To save the edited settings, perform the operation "Saving Your Settings (Write)" (refer to owner's manual).

About the Parameters

- Parameters marked with a "★" can be controlled using Matrix control (p. 12).
- Some parameters (such as Rate or Delay Time) can be set in terms of a note value.

	Sixty-fourth-note triplet		Sixty-fourth note		Thirty-second-note triplet		Thirty-second note
	Sixteenth-note triplet		Dotted thirty-second note		Sixteenth note		Eighth-note triplet
	Dotted sixteenth note		Eighth note		Quarter-note triplet		Dotted eighth note
	Quarter note		Half-note triplet		Dotted quarter note		Half note
	Whole-note triplet		Dotted half note		Whole note		Double-note triplet
	Dotted whole note		Double note				

NOTE

If you specify the delay time as a note value, slowing down the tempo will not change the delay time beyond a certain length.
This is because there is an upper limit for the delay time; if the delay time is specified as a note value and you slow down the tempo until this upper limit is reached, the delay time cannot change any further. This upper limit is the maximum value that can be specified when setting the delay time as a numerical value.

Patch Parameters

COMMON

Parameter	Value/Explanation
Patch Category	Specifies the type (category) of the patch. * If you select "NO ASSIGN" as the category, it won't be possible to select the patch on the JUNO-DS itself. Refer to "Category List" (p. 5).
Patch Level	Specifies the volume of the patch. 0–127
Patch Pan	Specifies the pan of the patch. "L64" is far left, "0" is center, and "63R" is far right. L64–0–63R
Patch Priority	This determines how notes will be managed when the maximum polyphony is exceeded (128 voices). LAST The last-played voices will be given priority, and currently sounding notes will be turned off in order, beginning with the first-played note. LOUDEST The voices with the loudest volume will be given priority, and currently sounding notes will be turned off, beginning with the lowest-volume voice.
Octave Shift	Adjusts the pitch of the patch's sound up or down in units of an octave (±3 octaves). -3–3
Patch Coarse Tune	Adjusts the pitch of the patch's sound up or down in semitone steps (±4 octaves). -48–48
Patch Fine Tune	Adjusts the pitch of the patch's sound up or down in 1-cent steps (±50 cents). -50–50
Stretch Tune	Stretched tuning (a system by which acoustic pianos are normally tuned, causing the lower range to be lower and the higher range to be higher than the mathematical tuning ratios would otherwise dictate) OFF Equal temperament 1–3 Higher settings will produce the greater difference in the pitch of the low and high ranges.
Stretch Tune Depth	
Analog Feel	Specifies the depth of 1/f modulation that is to be applied to the patch. By adding this "1/f modulation," you can simulate the natural instability characteristic of an analog synthesizer. 0–127
Cutoff Offset	Cutoff Frequency Offset alters the cutoff frequency of the overall patch, while preserving the relative differences between the cutoff frequency values set for each tone in the Cutoff Frequency (p. 8). * This value is added to the cutoff frequency value of a tone, so if the cutoff frequency value of any tone is already set to "127" (maximum), positive "+" settings here will not produce any change. -63–+63
Resonance Offset	Resonance Offset alters the resonance of the overall patch, while preserving the relative differences between the resonance values set for each tone in the Resonance (p. 8). * This value is added to the resonance value of a tone, so if the resonance value of any tone is already set to "127" (maximum), positive "+" settings here will not produce any change. -63–+63
Attack Time Offset	Attack Time Offset alters the attack time of the overall patch, while preserving the relative differences between the attack time values set for each tone in the TVA-Env Time 1 (p. 10), TVF-Env Time 1 (p. 9). * This value is added to the attack time value of a tone, so if the attack time value of any tone is already set to "127" (maximum), positive "+" settings here will not produce any change. -63–+63
Release Time Offset	Release Time Offset alters the release time of the overall patch, while preserving the relative differences between the release time values set for each tone in the TVA-Env Time 4 (p. 10), TVF-Env Time 4 (p. 9). * This value is added to the release time value of a tone, so if the release time value of any tone is already set to "127" (maximum), positive "+" settings here will not produce any change. -63–+63

Parameter	Value/Explanation
Velocity Sens Offset	Velocity Sens Offset alters the Velocity Sensitivity of the overall patch while preserving the relative differences between the Velocity Sensitivity values set for each tone in the parameters below. Cutoff V-Sens (p. 9) Level V-Sens (p. 10) * This value is added to the velocity sensitivity value of a tone, so if the velocity sensitivity value of any tone is already set to "+63" (maximum), positive "+" settings here will not produce any change. -63+63
Mono/Poly	Specifies whether the patch will play polyphonically (POLY) or monophonically (MONO). The "MONO" setting is effective when playing a solo instrument patch such as sax or flute. MONO Only the last-played note will sound. POLY Two or more notes can be played simultaneously.
Legato Switch	Specifies whether the Legato Switch will be used (ON) or not (OFF). With the Legato Switch parameter "ON," pressing a key while continuing to press a previous key causes the note to change pitch to the pitch of the most recently pressed key, sounding all the while. This creates a smooth transition between notes, which is effective when you wish to simulate the hammering-on and pulling-off techniques used by a guitarist. * Legato Switch is valid when the Mono/Poly is set to "MONO." OFF, ON
Legato Retrigger	The setting determines whether sounds are replayed (ON) or not (OFF) when performing legato. Normally you will leave this parameter "ON." When "OFF," when one key is held down and another key is then pressed, only the pitch changes, without the attack of the latter key being played. Set this to "OFF" when performing wind and string phrases or when using modulation with the mono synth keyboard sound. * Legato Retrigger is valid when the Mono/Poly is set to "MONO" and the Legato Switch is set to "ON." OFF, ON

MEMO

Let's say you have the Legato Switch set to "ON," and the Legato Retrigger set to "OFF." When you try to sound a legato (by pressing a higher key while a lower key is held down), the pitch may sometimes not be able to rise all the way to the intended pitch (stopping instead at an intermediate pitch). This can occur because the limit of pitch rise, as determined at the wave level, has been exceeded. Additionally, if differing upper pitch limits are used for the waves of a Patch that uses multiple tones, it may stop being heard in MONO. When making large pitch changes, set the Legato Retrigger to "ON."

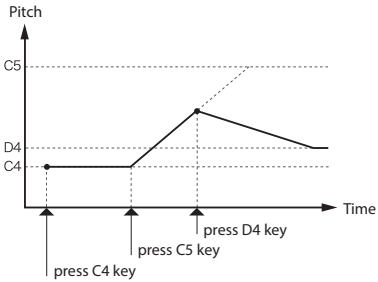
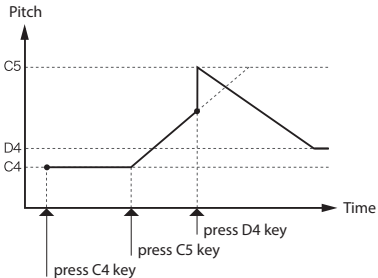
Portamento Switch	Specifies whether the portamento effect will be applied (ON) or not (OFF). OFF, ON
Portamento Mode	Specifies the performance conditions for which portamento will be applied. NORMAL Portamento will always be applied. LEGATO Portamento will be applied only when you play legato (i.e., when you press the next key before releasing the previous key).
Portamento Type	Specifies the type of portamento effect. RATE The time it takes will depend on the distance between the two pitches. TIME The time it takes will be constant, regardless of how far apart in pitch the notes are.
Portamento Start	When another key is pressed during a pitch change produced by portamento, a new pitch change will begin. This setting specifies the pitch at which the change will begin. PITCH Starts a new portamento when another key is pressed while the pitch is changing.  NOTE Portamento will begin anew from the pitch where the current change would end. 

Parameter	Value/Explanation
Portamento Time	When portamento is used, this specifies the time over which the pitch will change. Higher settings will cause the pitch change to the next note to take more time. 0-127

Category List

Category	Contents
- - -	No assign
PNO	AC. Piano
EP	EL. Piano
KEY	Keyboards
BEL	Bell
MLT	Mallet
ORG	Organ
ACD	Accordion
HRM	Harmonica
AGT	AC. Guitar
EGT	EL. Guitar
DGT	DIST. Guitar
BS	Bass
SBS	Synth Bass
STR	Strings
ORC	Orchestra
HIT	Hit&Stab
WND	Wind
FLT	Flute
BRS	AC. Brass
SBR	Synth Brass
SAX	Sax
HLD	Hard Lead
SLD	Soft Lead
TEK	Techno Synth
PLS	Pulsating
FX	Synth FX
SYN	Other Synth
BPD	Bright Pad
SPD	Soft Pad
VOX	Vox
PLK	Plucked
ETH	Ethnic
FRT	Fretted
PRC	Percussion
SFX	Sound FX
BTS	Beat&Groove
DRM	Drums
CMB	Combination

WAVE

Parameter	Value/Explanation	
□1-□4	Specify the on/off status of tones 1-4. If a tone is on, a "✓" mark is shown. OFF, ON	
Wave Group	Selects the group for the waveform that is to be the basis of the tone.	
	INTA, B	Waveforms stored in internal
	EXP	Waveforms for expansion sounds
	SAMP	Imported user sample waveforms
MSAM	Multisamples created by JUNO-DS Tone Manager (PC software)	
Wave No. L (Mono)	Selects the basic waveform for a tone. Along with the Wave number, the Wave name appears at the lower part of the display.	
Wave No. R	When in mono, only the left side (L) is specified. When in stereo, the right side (R) is also specified. OFF, 1-2402 (The upper limit will depend on the wave group.)	
Wave Gain	Sets the gain (amplification) of the waveform. The value changes in 6 dB (decibel) steps—an increase of 6 dB doubles the waveform's gain. If you intend to use the Booster to distort the waveform's sound, set this parameter to its maximum value (p. 7). -6, 0, +6, +12	
Wave Tempo Sync	When you wish to synchronize a Phrase Loop to the clock (tempo), set this to "ON." OFF, ON	
Wave FXM Switch	Phrase loop refers to the repeated playback of a phrase that's been pulled out of a song (e.g., by using a sampler).	
	Sets whether FXM will be used (ON) or not (OFF). OFF, ON	
Wave FXM Color	FXM (Frequency Cross Modulation) uses a specified waveform to apply frequency modulation to the currently selected waveform, creating complex overtones. This is useful for creating dramatic sounds or sound effects.	
	Specifies how FXM will perform frequency modulation. Higher settings result in a grainier sound, while lower settings result in a more metallic sound. 1-4	
★ Wave FXM Depth	Specifies the depth of the modulation produced by FXM. 0-16	
Tone Delay Mode	Selects the type of tone delay.	
	NORM	The tone begins to play after the time specified in the Tone Delay Time has elapsed.
	HOLD	Although the tone begins to play after the time specified in the Tone Delay Time has elapsed, if the key is released before the time specified in the Tone Delay Time has elapsed, the tone is not played.
	OFF-N	Rather than being played while the key is pressed, the tone begins to play once the period of time specified in the Tone Delay Time has elapsed after release of the key. This is effective in situations such as when simulating noises from guitars and other instruments.

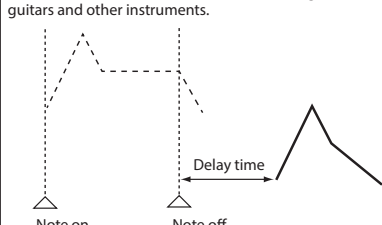
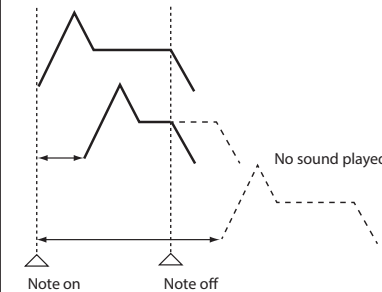
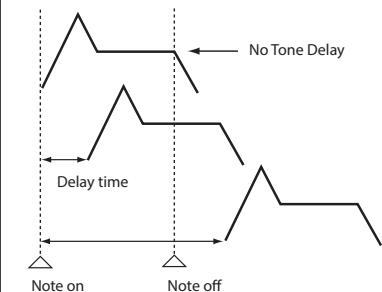

Parameter	Value/Explanation
OFF-D	Rather than being played while the key is pressed, the tone begins to play once the period of time specified in the Tone Delay Time has elapsed after release of the key. Here, however, changes in the TVA Envelope begin while the key is pressed, which in many cases means that only the sound from the release portion of the envelope is heard.
MEMO	If you have selected a waveform that is a decay-type sound (i.e., a sound that fades away naturally even if the key is not released), selecting "OFF-N" or "OFF-D" may result in no sound being heard.
Tone Delay Time	Specifies the time from when the key is pressed (or if the Delay Mode is set to "OFF-N" or "OFF-D," the time from when the key is released) until when the tone will sound. 0-127, note

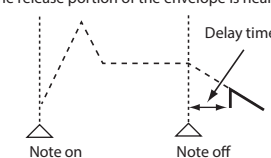

TMT

Parameter	Value/Explanation	
Structure Type 1 & 2, 3 & 4	Determines how tone 1 and 2, or tone 3 and 4 are connected. The following 10 different Types of combination are available.	
	1	With this type, tones 1 and 2 (or 3 and 4) are independent. Use this type when you want to preserve PCM sounds or create and combine sounds for each tone.
	2	This type stacks the two filters together to intensify the characteristics of the filters. The TVA for tone 1 (or 3) controls the volume balance between the two tones.
	3	This type mixes the sound of tone 1 (3) and tone 2 (4), applies a filter, and then applies a booster to distort the waveform.
	4	This type applies a booster to distort the waveform, and then combines the two filters. The TVA for tone 1 (or 3) controls the volume balance between the two tones and adjusts booster level.
	5	This type uses a ring modulator to create new overtones, and combines the two filters. The tone 1 (3) TVA will control the volume balance of the two tones, adjusting the depth of ring modulator.
6	This type uses a ring modulator to create new overtones, and in addition mixes in the sound of tone 2 (4) and stacks the two filters. Since the ring-modulated sound can be mixed with tone 2 (4), tone 1 (3) TVA can adjust the amount of the ring-modulated sound.	

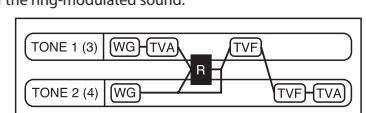
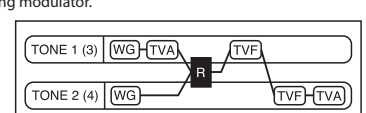
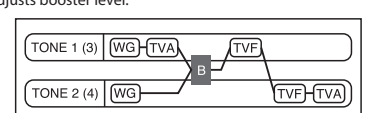
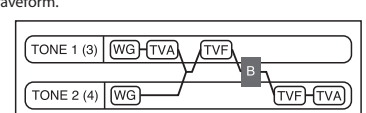
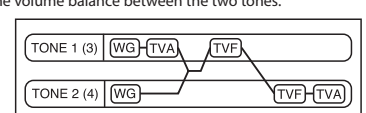
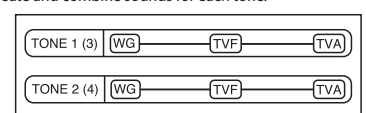

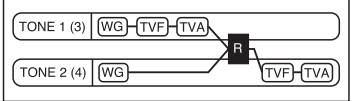
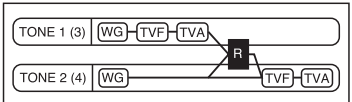
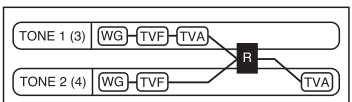
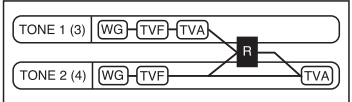
Parameter	Value/Explanation
7	<p>This type applies a filter to tone 1 (3) and ring-modulates it with tone 2 (4) to create new overtones.</p> 
8	<p>This type sends the filtered tone 1 (3) and tone 2 (4) through a ring modulator, and then mixes in the sound of tone 2 (4) and applies a filter to the result.</p> 
9	<p>This type passes the filtered sound of each tone through a ring modulator to create new overtones. The tone 1 (3) TVA will control the volume balance of the two tones, adjusting the depth of ring modulator.</p> 
10	<p>This type passes the filtered sound of each tone through a ring modulator to create new overtones, and also mixes in the sound of tone 2 (4). Since the ring-modulated sound can be mixed with tone 2 (4), tone 1 (3) TVA can adjust the amount of the ring-modulated sound.</p> 

MEMO

- When type 2-10 is selected and one tone of a pair is turned off, the other tone will be sounded as type 1 regardless of the displayed setting.
- If you limit the keyboard area in which a tone will sound (Key Range Upper, Lower) or limit the range of velocities for which it will sound (Velo Range Upper, Lower), the result in areas or ranges where the tone does not sound is just as if the tone had been turned off. This means that if type 2-10 is selected and you create a keyboard area or velocity range in which one tone of a pair does not sound, notes played in that area or range will be sounded by the other tone as TYPE 1 regardless of the displayed setting.

Booster 1 & 2, 3 & 4	<p>When a Structure Type of 3 or 4 is selected, you can adjust the depth of the booster. The booster increases the input signal in order to distort the sound. This creates the distortion effect frequently used with electric guitars. Higher settings will produce more distortion.</p> <p>0, +6, +12, +18</p>
Key Fade Upper, Lower	<p>This determines what will happen to the tone's level when a note that's higher/lower than the tone's specified keyboard range is played. Higher settings produce a more gradual change in volume. If you don't want the tone to sound at all when a note below the keyboard range is played, set this parameter to "0."</p> <p>0-127</p>
Key Range Upper, Lower	<p>Specifies the highest/lowest note that the tone will sound for each tone.</p> <p>* If you attempt to raise the lower key higher than the upper key, or to lower the upper key below the lower key, the other value will be automatically modified to the same setting.</p> <p>(Upper) LOWER-G9, (Lower) C-1-UPPER</p>

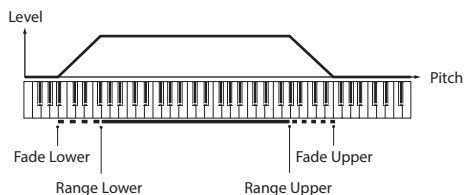

TMT Velocity Control	<p>TMT Velocity Control determines whether a different tone is played or not depending on the force with which the key is played (velocity).</p> <p>* Instead of using Velocity, you can also have tones substituted using the Matrix control (p. 12). However, the keyboard velocity and the Matrix control cannot be used simultaneously to make different tones to sound. When using the Matrix control to switch tones, set the Velocity Control to "OFF."</p>
OFF	Tones are not velocity-switched.
ON	Tones are switched according to the keyboard playing velocity.
RANDOM	The patch's constituent tones will sound randomly, regardless of the velocity.
CYCLE	The patch's constituent tones will sound consecutively, regardless of the velocity.
Velo Fade Upper, Lower	<p>This determines what will happen to the tone's level when the tone is played at a velocity Upper/lower than its specified velocity range. Higher settings produce a more gradual change in volume. If you want notes played outside the specified key velocity range to not be sounded at all, set this to "0."</p> <p>0-127</p>

Parameter	Value/Explanation
Velo Range Upper, Lower	<p>Sets the highest/lowest velocity at which the tone will sound.</p> <p>* If you attempt to set the Lower velocity limit above the Upper, or the Upper below the Lower, the other value will automatically be adjusted to the same setting.</p> <p>(Upper) LOWER-127, (Lower) 1-UPPER</p>

MEMO

When using the Matrix Control to have different tones played, set the lowest value (Lower) and highest value (Upper) of the value of the MIDI message used.

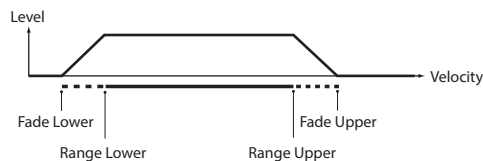

TMT Control Switch	<p>Use the Matrix control to enable (ON), or disable (OFF) sounding of different tones.</p> <p>* You can also cause different tones to sound in response to notes played at different strengths (velocity) on the keyboard (p. 7). However, the Matrix control and the keyboard velocity cannot be used simultaneously to make different tones to sound. When you want to make the different tones to sound, set the TMT Velocity Control (p. 7) to "OFF."</p> <p>OFF, ON</p>
-----------------------	---

PITCH

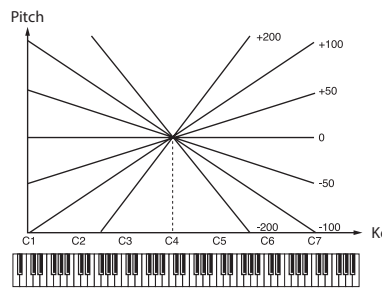
Parameter	Value/Explanation
Tone Coarse Tune	<p>Adjusts the pitch of the tone's sound up or down in semitone steps (± 4 octaves).</p> <p>-48-+48</p>
Tone Fine Tune	<p>Adjusts the pitch of the tone's sound up or down in 1-cent steps (± 50 cents).</p> <p>-50-+50</p>
Random Pitch Depth	<p>Specifies the width of random pitch deviation that will occur each time a key is pressed. If you do not want the pitch to change randomly, set this to "0." These values are in units of cents (1/100th of a semitone).</p> <p>0-1200</p>
Pitch Keyfollow	<p>Specifies the amount of pitch change that will occur when you play a key one octave higher (i.e., 12 keys upward on the keyboard). If you want the pitch to rise one octave as on a conventional keyboard, set this to "+100." If you want the pitch to rise two octaves, set this to "+200." Conversely, set this to a negative value if you want the pitch to fall. With a setting of "0," all keys will produce the same pitch.</p> <p>-200-+200</p> 
Pitch Bend Range Up, Down	<p>Specifies the degree of pitch change in semitones when the Pitch Bend lever is all the way right (left).</p> <p>For example if this is set to "+48 (-48)" and you move the pitch bend lever all the way to the right (left), the pitch will rise (fall) 4 octaves.</p> <p>(Up) 0-+48, (Down) 0- -48</p>

PITCH ENV

Parameter	Value/Explanation
Pitch Env Depth	Adjusts the effect of the Pitch Envelope. Higher settings will cause the pitch envelope to produce greater change. Negative (-) settings will invert the shape of the envelope. -12--+12
Pitch Env V-Sens	Keyboard playing dynamics can be used to control the depth of the pitch envelope. If you want the pitch envelope to have more effect for strongly played notes, set this parameter to a positive (+) value. If you want the pitch envelope to have less effect for strongly played notes, set this to a negative (-) value. -63--+63
Pitch Env T1 V-Sens	This allows keyboard dynamics to affect the Time 1 of the Pitch envelope. If you want Time 1 to be speeded up for strongly played notes, set this parameter to a positive (+) value. If you want it to be slowed down, set this to a negative (-) value. -63--+63
Pitch Env T4 V-Sens	Use this parameter when you want key release speed to affect the Time 4 value of the pitch envelope. If you want Time 4 to be speeded up for quickly released notes, set this parameter to a positive (+) value. If you want it to be slowed down, set this to a negative (-) value. -63--+63
Pitch Env Time KF	Use this setting if you want the pitch envelope times (Time 2–Time 4) to be affected by the keyboard location. Based on the pitch envelope times for the C4 key, positive (+) settings will cause notes higher than C4 to have increasingly shorter times, and negative (-) settings will cause them to have increasingly longer times. Larger settings will produce greater change. -100--+100
★ Pitch Env Time 1–4	Specify the pitch envelope times (Time 1–Time 4). Higher settings will result in a longer time until the next pitch is reached. (For example, Time 2 is the time over which the pitch changes from Level 1 to Level 2.) 0–127
	Specify the pitch envelope levels (Level 0–Level 4). It determines how much the pitch changes from the reference pitch (the value set with Coarse Tune or Fine Tune on the Pitch screen) at each point. Positive (+) settings will cause the pitch to be higher than the standard pitch, and negative (-) settings will cause it to be lower. -63--+63

T: Time L: Level

TVF

Parameter	Value/Explanation
Filter Type	Selects the type of filter. A filter cuts or boosts a specific frequency region to change a sound's brightness, thickness, or other qualities. * If you set "LPF2" or "LPF3," the setting for the Resonance (p. 8) will be ignored.
OFF	No filter is used.
LPF	Low Pass Filter. This reduces the volume of all frequencies above the cutoff frequency in order to round off, or un-brighten the sound. This is the most common filter used in synthesizers.
BPF	Band Pass Filter. This leaves only the frequencies in the region of the cutoff frequency, and cuts the rest. This can be useful when creating distinctive sounds.
HPF	High Pass Filter. This cuts the frequencies in the region below the cutoff frequency. This is suitable for creating percussive sounds emphasizing their higher tones.
PKG	Peaking Filter. This emphasizes the frequencies in the region of the cutoff frequency. You can use this to create wah-wah effects by employing an LFO to change the cutoff frequency cyclically.
LPF2	Low Pass Filter 2. Although frequency components above the cutoff frequency are cut, the sensitivity of this filter is half that of the LPF. This makes it a comparatively warmer low pass filter. This filter is good for use with simulated instrument sounds such as the acoustic piano.
LPF3	Low Pass Filter 3. Although frequency components above the cutoff frequency are cut, the sensitivity of this filter changes according to the cutoff frequency. While this filter is also good for use with simulated acoustic instrument sounds, the nuance it exhibits differs from that of the LPF2, even with the same TVF Envelope settings.
★ Cutoff Frequency	<div style="display: flex; justify-content: space-around;"> <div> <p>Level</p> <p>High</p> <p>Low</p> </div> <div> <p>LPF</p> <p>BPF</p> <p>HPF</p> <p>PKG</p> </div> </div>
	Selects the frequency at which the filter begins to have an effect on the waveform's frequency components. "LPF/LPF2/LPF3" selected for the Filter Type Lower cutoff frequency settings reduce a tone's upper harmonics for a more rounded, warmer sound. Higher settings make it sound brighter. "BPF" selected for the Filter Type Harmonic components will change depending on the TVF Cutoff Frequency setting. This can be useful when creating distinctive sounds. "HPF" selected for the Filter Type Higher Cutoff Frequency settings will reduce lower harmonics to emphasize just the brighter components of the sound. "PKG" selected for the Filter Type The harmonics to be emphasized will vary depending on Cutoff Frequency setting.
	MEMO To edit the overall patch while preserving the relative differences in the Cutoff Frequency values set for each tone, set the Cutoff Offset (p. 4). 0–127
	Emphasizes the portion of the sound in the region of the cutoff frequency, adding character to the sound. Excessively high settings can produce oscillation, causing the sound to distort. 0–127
★ Resonance	Use this parameter if you want the cutoff frequency to change according to the key that is pressed. Relative to the cutoff frequency at the C4 key (center C), positive (+) settings will cause the cutoff frequency to rise for notes higher than C4, and negative (-) settings will cause the cutoff frequency to fall for notes higher than C4. Larger settings will produce greater change. -200--+200
Cutoff Keyfollow	

Parameter	Value/Explanation
Cutoff V-Curve	<p>Selects one of the following seven curves that determine how keyboard playing dynamics (velocity) influence the cutoff frequency. Set this to "FIXED" if you don't want the Cutoff frequency to be affected by the keyboard velocity.</p> <p>FIXED, 1-7</p> 
Cutoff V-Sens	<p>Use this parameter when changing the cutoff frequency to be applied as a result of changes in playing velocity. If you want strongly played notes to raise the cutoff frequency, set this parameter to positive (+) settings. If you want strongly played notes to lower the cutoff frequency, use negative (-) settings.</p> <p>MEMO</p> <p>To edit the overall patch while preserving the relative differences in the Cutoff V-Sens values set for each tone, set the Velocity Sens Offset (p. 5). However, this setting is shared by the Level V-Sens (p. 10).</p> <p>-63+63</p>
Resonance V-Sens	<p>This allows keyboard velocity to modify the amount of Resonance. If you want strongly played notes to have a greater Resonance effect, set this parameter to positive (+) settings. If you want strongly played notes to have less Resonance, use negative (-) settings.</p> <p>-63+63</p>

TVF ENV

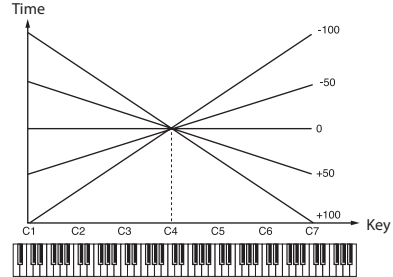
Parameter	Value/Explanation
TVF Env Depth	<p>Specifies the depth of the TVF envelope. Higher settings will cause the TVF envelope to produce greater change. Negative (-) settings will invert the shape of the envelope.</p> <p>-63+63</p>
TVF Env V-Curve	<p>Selects one of the following 7 curves that will determine how keyboard playing dynamics will affect the TVF envelope. Set this to "FIXED" if you don't want the TVF Envelope to be affected by the keyboard velocity.</p> <p>FIXED, 1-7</p> 
TVF Env V-Sens	<p>Specifies how keyboard playing dynamics will affect the depth of the TVF envelope. Positive (+) settings will cause the TVF envelope to have a greater effect for strongly played notes, and negative (-) settings will cause the effect to be less.</p> <p>-63+63</p>
TVF Env T1 V-Sens	<p>This allows keyboard dynamics to affect the Time 1 of the TVF envelope. If you want Time 1 to be speeded up for strongly played notes, set this parameter to a positive (+) value. If you want it to be slowed down, set this to a negative (-) value.</p> <p>-63+63</p>
TVF Env T4 V-Sens	<p>The parameter to use when you want key release speed to control the Time 4 value of the TVF envelope. If you want Time 4 to be speeded up for quickly released notes, set this parameter to a positive (+) value. If you want it to be slowed down, set this to a negative (-) value.</p> <p>-63+63</p>
TVF Env Time Keyfollow	<p>Use this setting if you want the TVA envelope times (Time 2–Time 4) to be affected by the keyboard location. Based on the TVF envelope times for the C4 key (center C), positive (+) settings will cause notes higher than C4 to have increasingly shorter times, and negative (-) settings will cause them to have increasingly longer times. Larger settings will produce greater change.</p> <p>-100+100</p> 
★ TVF Env Time 1-4	<p>Specify the TVF envelope times (Time 1–Time 4). Higher settings will lengthen the time until the next cutoff frequency level is reached. (For example, Time 2 is the time over which Level 1 will change to Level 2.)</p> <p>0-127</p>
TVF Env Level 0-4	<p>Specify the TVF envelope levels (Level 0–Level 4). These settings specify how the cutoff frequency will change at each point, relative to the standard cutoff frequency (the cutoff frequency value specified in the TVF screen).</p> <p>0-127</p>

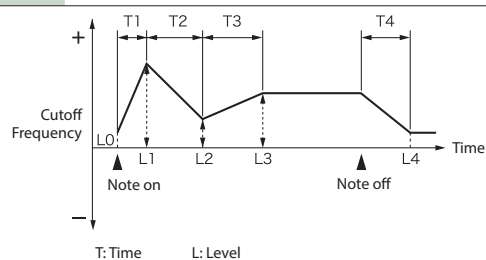

TVA

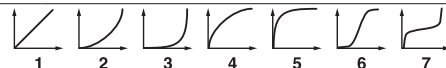
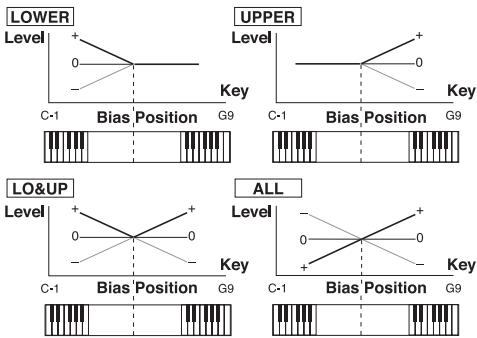
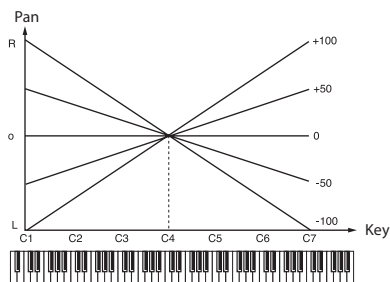
Parameter	Value/Explanation
★ Tone Level	Sets the volume of the tone. This setting is useful primarily for adjusting the volume balance between tones. 0-127
Level V-Curve	You can select from seven curves that determine how keyboard playing strength will affect the volume. If you do not want the volume of the tone to be affected by the force with which you play the key, set this to "FIXED." FIXED, 1-7 
Level V-Sens	Set this when you want the volume of the tone to change depending on the force with which you press the keys. Set this to a positive (+) value to have the changes in tone volume increase the more forcefully the keys are played; to make the tone play more softly as you play harder, set this to a negative (-) value. MEMO If you wish to make adjustments to the entire patch while maintaining the relative values of Level V-Sens among tones, adjust the Velocity Sens Offset (p. 5). However, this setting is shared by the Cutoff V-Sens (p. 9). -63+63
Bias Level	Adjusts the angle of the volume change that will occur in the selected Bias Direction. Larger settings will produce greater change. Negative (-) values will invert the change direction. -100+100
Bias Position	Specifies the key relative to which the volume will be modified. C- G9
Bias Direction	Selects the direction in which change will occur starting from the Bias Position. LWR The volume will be modified for the keyboard area below the Bias Point. UPR The volume will be modified for the keyboard area above the Bias Point. L&U The volume will be modified symmetrically toward the left and right of the Bias Point. ALL The volume changes linearly with the bias point at the center.
Bias	Bias causes the volume to be affected by the keyboard position. This is useful for changing volume through keyboard position (pitch) when playing acoustic instruments. 
★ Tone Pan	Sets the pan of the tone. "L64" is far left, "0" is center, and "63R" is far right. L64-0-63R Use this parameter if you want key position to affect panning. Positive (+) settings will cause notes higher than C4 key (center C) to be panned increasingly further toward the right, and negative (-) settings will cause notes higher than C4 key (center C) to be panned toward the left. Larger settings will produce greater change. -100+100
Pan Keyfollow	
Random Pan Depth	Use this parameter when you want the stereo location to change randomly each time you press a key. Higher settings will produce a greater amount of change. 0-63

Parameter	Value/Explanation
Alternate Pan Depth	This setting causes panning to be alternated between left and right each time a key is pressed. Higher settings will produce a greater amount of change. "L" or "R" settings will reverse the order in which the pan will alternate between left and right. For example if two tones are set to "L" and "R" respectively, the panning of the two tones will alternate each time they are played. L63-0-63R

MEMO

When any value from Type "2"- "10" is selected for the Structure Type (p. 6) in the Pan Keyfollow, Random Pan Depth, Alternate Pan Depth settings, the output of tones 1 and 2 are joined in tone 2, and the output of tones 3 and 4 are joined in tone 4. For this reason, tone 1 will follow the settings of tone 2, and tone 3 will follow the settings of tone 4.

TVA ENV

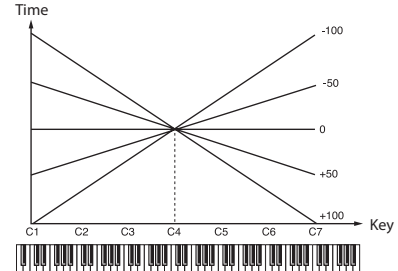
Parameter	Value/Explanation
TVA-Env T1 V-Sens	This allows keyboard dynamics to affect the Time 1 of the TVA envelope. If you want Time 1 to be speeded up for strongly played notes, set this parameter to a positive (+) value. If you want it to be slowed down, set this to a negative (-) value. -63+63
TVA-Env T4 V-Sens	The parameter to use when you want key release speed to control the Time 4 value of the TVA envelope. If you want Time 4 to be speeded up for quickly released notes, set this parameter to a positive (+) value. If you want it to be slowed down, set this to a negative (-) value. -63+63
TVA-Env Time KF	Use this setting if you want the TVA envelope times (Time 2-Time 4) to be affected by the keyboard location. Based on the TVA envelope times for the C4 key (center C), positive (+) settings will cause notes higher than C4 to have increasingly shorter times, and negative (-) settings will cause them to have increasingly longer times. Larger settings will produce greater change. -100+100 
★ TVA-Env Time 1-4	Specify the TVA envelope times (Time 1-Time 4). Higher settings will lengthen the time until the next volume level is reached. (For example, Time 2 is the time over which Level 1 will change to Level 2.) 0-127
TVA-Env Level 1-3	Specify the TVA envelope levels (Level 1-Level 3). These settings specify how the volume will change at each point, relative to the standard volume (the Tone Level value specified in the TVA screen). 0-127

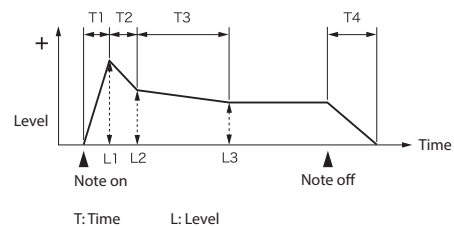

OUTPUT

Parameter	Value/Explanation
Patch Output Assign	Specifies how the direct sound of each patch will be output.
	MFX Output in stereo through MFX. You can also apply chorus or reverb to the sound that passes through MFX.
	L+R Output to the OUTPUT L (MONO) jack and OUTPUT R jack in stereo without passing through MFX.
	L, R Output to the OUTPUT L (MONO) jack or OUTPUT R jack in mono without passing through MFX.
TONE Outputs according to the settings for each tone.	
Tone Output Assign	Specifies how the direct sound of each tone will be output.
	* If the Patch Output Assign is set to anything other than "TONE," these settings will be ignored.
	* When the Structure Type (p. 6) has a setting of "2"–"10," the outputs of tones 1 and 2 will be combined with tone 2, and the outputs of tones 3 and 4 will be combined with tone 4. For this reason, tone 1 will follow the settings of tone 2, and tone 3 will follow the settings of tone 4.
	* Chorus and reverb are output in mono at all times.
MFX Output in stereo through MFX. You can also apply chorus or reverb to the sound that passes through MFX.	
L+R Output to the OUTPUT L (MONO) jack and OUTPUT R jack in stereo without passing through MFX.	
L, R Output to the OUTPUT L (MONO) jack or OUTPUT R jack in mono without passing through MFX.	
Tone Output Level	Set the level of the signal that is sent to the output destination specified by Patch Output Assign or Tone Output Assign. 0–127
Tone Chorus Send	Specifies the level of the signal sent to the chorus for each tone. 0–127
Tone Reverb Send	Specifies the level of the signal sent to the reverb for each tone. 0–127

LFO1, 2

Parameter	Value/Explanation
Waveform	Selects the waveform of the LFO.
	* If you set this to "BD-U" or "BD-D," you must turn the Key Trigger parameter to "ON." If this is "OFF," it will have no effect.
	SIN Sine wave
	TRI Triangle wave
	SAWU Sawtooth wave
	SAWD Sawtooth wave (negative polarity)
	SQR Square wave
	RND Random wave
	BD-U Once the attack of the waveform output by the LFO is allowed to develop in standard fashion, the waveform then continues without further change.
	BD-D Once the decay of the waveform output by the LFO is allowed to develop in standard fashion, the waveform then continues without further change.
	TRP Trapezoidal wave
	S&H Sample & Hold wave (one time per cycle, LFO value is changed)
	CHS Chaos wave
VSIN Modified sine wave. The amplitude of a sine wave is randomly varied once each cycle.	
STEP A waveform generated by the data specified by LFO Step 1–16. This produces stepped change with a fixed pattern similar to a step modulator.	
★ Rate	Adjusts the modulation rate, or speed, of the LFO. * This setting will be ignored if the Waveform parameter is set to "CHS." 0–127, note
Rate Detune	LFO Rate Detune makes subtle changes in the LFO cycle rate (Rate) each time a key is pressed. Higher settings will cause greater change. * This parameter is invalid when Rate is set to "note." 0–127
Offset	Raises or lowers the LFO waveform relative to the central value (pitch or cutoff frequency). Positive (+) settings will move the waveform so that modulation will occur from the central value upward. Negative (-) settings will move the waveform so that modulation will occur from the central value downward. -100, -50, 0, +50, +100
Delay Time	Delay Time (LFO Delay Time) specifies the time elapsed before the LFO effect is applied (the effect continues) after the key is pressed (or released). * After referring to "How to Apply the LFO" (p. 12), change the setting until the desired effect is achieved. 0–127

Parameter	Value/Explanation
Delay Time KF	Adjusts the value for the Delay Time depending on the key position, relative to the C4 key (center C). To decrease the time that elapses before the LFO effect is applied (the effect is continuous) with each higher key that is pressed in the upper registers, select a positive value; to increase the elapsed time, select a negative value. Larger settings will produce greater change. If you do not want the elapsed time before the LFO effect is applied (the effect is continuous) to change according to the key pressed, set this to "0."
	-100–+100
Fade Mode	Specifies how the LFO will be applied. * After referring to "How to Apply the LFO" (p. 12), change the setting until the desired effect is achieved. ON <, ON >, OFF <, OFF >
	ON <, ON >, OFF <, OFF >
Fade Time	Specifies the time over which the LFO amplitude will reach the maximum (minimum). * After referring to "How to Apply the LFO" (p. 12), change the setting until the desired effect is achieved.
	0–127
Key Trigger	Specifies whether the LFO cycle will be synchronized to begin when the key is pressed (ON) or not (OFF).
	OFF, ON
★ Pitch Depth	Specifies how deeply the LFO will affect pitch. -63–+63
★ TVF Depth	Specifies how deeply the LFO will affect the cutoff frequency. -63–+63
★ TVA Depth	Specifies how deeply the LFO will affect the volume. -63–+63
★ Pan Depth	Specifies how deeply the LFO will affect the pan.
	MEMO When the Structure Type (p. 6) is set to any value from "2" through "10," the output of tones 1 and 2 will be combined into tone 2, and the output of tones 3 and 4 will be combined into tone 4. This applies to the Pan Depth settings. For this reason, tone 1 will follow the settings of tone 2, and tone 3 will follow the settings of tone 4. -63–+63

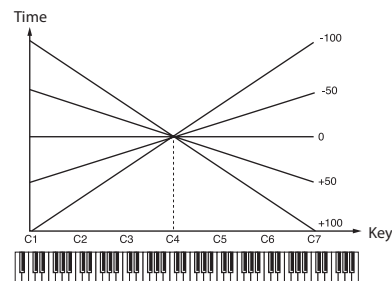

STEP LFO

Parameter	Value/Explanation
Step Type	When generating an LFO waveform from the data specified in LFO Step 1–16, specify whether the level will change abruptly at each step (TYP1) or will be connected linearly (TYP2).
	TYP1, TYP2
LFO Step 1–16	Specifies the data for the Step LFO. If the LFO Pitch Depth is +63, each +1 unit of the step data corresponds to a pitch of +50 cents. -36–+36

How to Apply the LFO

Apply the LFO gradually after the key is pressed

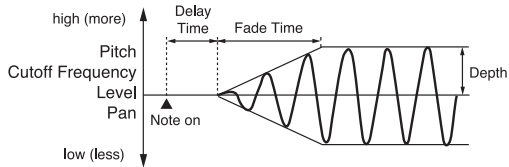

Parameter	Value/Explanation
Fade Mode	ON <
Delay Time	The time from when the keyboard is played until the LFO begins to be applied.
Fade Time	The time over which the LFO amplitude will reach the maximum after the Delay Time has elapsed.

Apply the LFO immediately when the key is pressed, and then gradually begin to decrease the effect

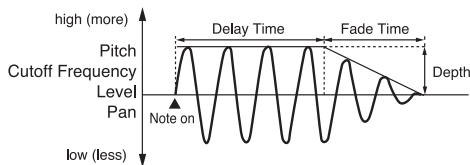

Parameter	Value/Explanation
Fade Mode	ON >
Delay Time	The time that the LFO will continue after the keyboard is played.
Fade Time	The time over which the LFO amplitude will reach the minimum after the Delay Time has elapsed.

Apply the LFO gradually after the key is released

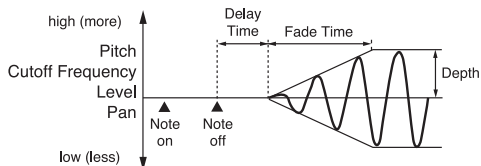

Parameter	Value/Explanation
Fade Mode	OFF <
Delay Time	The time from when the keyboard is released until the LFO begins to be applied.
Fade Time	The time over which the LFO amplitude will reach the maximum after the Delay Time has elapsed.

Apply the LFO from when the key is pressed until it is released, and gradually begin to decrease the effect when the key is released

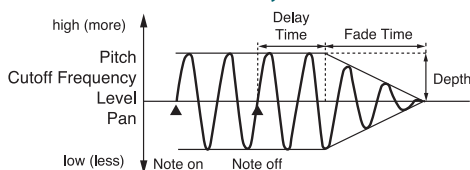

Parameter	Value/Explanation
Fade Mode	OFF >
Delay Time	The time that the LFO will continue after the keyboard is released.
Fade Time	The time over which the LFO amplitude will reach the minimum after the Delay Time has elapsed.

CTRL

Parameter	Value/Explanation				
	When a loop waveform is selected, the sound will normally continue as long as the key is pressed. If you want the sound to decay naturally even if the key remains pressed, set this to "NOSUS." * If a one-shot type waveform is selected, it will not sustain even if this parameter is set to "SUST."				
	NOSUS, SUST				
	MEMO				
Env Mode	<ul style="list-style-type: none"> One-shot: These waveforms contain sounds that have short decays. A one-shot waveform records the initial rise and fall of the sound. Some of the JUNO-DS's one-shot waveforms are sounds that are complete in themselves, such as percussive instrument sounds. The JUNO-DS also contains many other one-shot waveforms that are elements of other sounds. These include attack components such as piano-hammer sounds and guitar fret noises. Looped: These waveforms include sounds with long decays as well as sustained sounds. Loop waveforms repeatedly play back (loop) the portion of the waveform after the sound has reached a relatively steady state. The JUNO-DS's looped waveforms also include components of other sounds, such as piano-string resonant vibrations and the hollow sounds of brass instruments. 				
Rx Bender	For each tone, specify whether MIDI Pitch Bend messages will be received (ON), or not (OFF). OFF, ON				
Rx Expression	For each tone, specify whether MIDI Expression messages will be received (ON), or not (OFF). OFF, ON				
Rx Hold-1	For each tone, specify whether MIDI Hold-1 messages will be received (ON), or not (OFF). * If "NOSUS" is selected for Env Mode parameter, this setting will have no effect. OFF, ON				
	For each tone, specify how pan messages will be received. * The channels cannot be set so as not to receive Pan messages.				
Rx Pan Mode	<table border="1"> <tr> <td>CONT</td> <td>Whenever Pan messages are received, the stereo position of the tone will be changed.</td> </tr> <tr> <td>K-ON</td> <td>The pan of the tone will be changed only when the next note is played. If a pan message is received while a note is sounding, the panning will not change until the next key is pressed.</td> </tr> </table>	CONT	Whenever Pan messages are received, the stereo position of the tone will be changed.	K-ON	The pan of the tone will be changed only when the next note is played. If a pan message is received while a note is sounding, the panning will not change until the next key is pressed.
CONT	Whenever Pan messages are received, the stereo position of the tone will be changed.				
K-ON	The pan of the tone will be changed only when the next note is played. If a pan message is received while a note is sounding, the panning will not change until the next key is pressed.				
Redamper Sw	You can specify, on an individual tone basis, whether or not the sound will be held when a Hold 1 message is received after a key is released, but before the sound has decayed to silence. If you want to sustain the sound, set this "ON." When using this function, also set the Rx Hold-1 "ON." This function is effective for piano sounds. OFF, ON				

Matrix control

Ordinarily, if you wanted to change tone parameters using an external MIDI device, you would need to send System Exclusive messages—MIDI messages designed exclusively for the JUNO-DS. However, System Exclusive messages tend to be complicated, and the amount of data that needs to be transmitted can get quite large.

For that reason, a number of the more typical of the JUNO-DS's tone parameters have been designed so they accept the use of Control Change (or other) MIDI messages for the purpose of making changes in their values. This provides you with a variety of means of changing the way patches are played. For example, you can use the Pitch Bend lever to change the LFO cycle rate, or use the keyboard's touch to open and close a filter.

The function which allows you use MIDI messages to make these changes in realtime to the tone parameters is called the Matrix control. Up to four Matrix Controls can be used in a single patch.

To use the Matrix control, specify which MIDI message (Source) will be used to control which parameter (Dest), and how greatly (Sens), and the tone to which the effect is applied (Switch).

MTRX CTRL1-4

Parameter	Value/Explanation	
Control 1-4 Source	Sets the MIDI message used to change the tone parameter with the Matrix Control.	
	OFF	Matrix control will not be used.
	CC01-32, 33-95	Controller numbers 1-32, 33-95
	PITCH BEND	Pitch Bend
	AFTERTOUCH	Aftertouch
	SYS CTRL1-SYS CTRL4	MIDI messages used as common matrix controls.
	VELOCITY	Velocity (pressure you press a key with)
	KEY FOLLOW	Key follow (keyboard position with C4 as 0)
	* Velocity and Key follow correspond to Note messages.	
	TEMPO	The specified tempo (sequencer tempo) or the tempo of an external MIDI sequencer.
	LFO1, 2	LFO1, 2
	PITCH ENV	Pitch envelope
	TVF ENV	TVF envelope
	TVA ENV	TVA envelope

- Although there are no MIDI messages for LFO 1 through TVA Envelope, they can be used as Matrix Control. In this case, you can change the tone settings in realtime by playing patches.
- If you want to use common controllers for the entire JUNO-DS, select "SYS CTRL1"-"SYS CTRL4." MIDI messages used as System Control 1-4 are set with the System Ctrl 1-4 Source (p. 34).

MEMO

- There are parameters that determine whether or not Pitch bend, Controller number 11 (Expression) and Controller number 64 (Hold 1) are received (p. 12). When these settings are "ON," and the MIDI messages are received, then when any change is made in the settings of the desired parameter, the Pitch bend, Expression, and Hold 1 settings also change simultaneously. If you want to change the targeted parameters only, then set these to "OFF."
- There are parameters that let you specify whether specific MIDI messages will be received for each channel in a performance (p. 20). When a patch with Matrix control settings is assigned to a part, confirm that any MIDI messages used for the Matrix control will be received. If the JUNO-DS is set up such that reception of MIDI messages is disabled, then the Matrix control will not function.

Control Dest1-4	Matrix control destination selects the tone parameter that is to be controlled when using the Matrix control. The following parameters can be controlled. When not controlling parameters with the Matrix Control, set this to "OFF." Up to four parameters can be specified for each Matrix Control, and controlled simultaneously.	
	OFF	Matrix control will not be used.
	Changing the pitch	
	PCH	Changes the pitch.
	Opening and closing the filter	
	CUT	Changes the cutoff frequency.
	RES	Emphasizes the overtones in the region of the cutoff frequency, adding character to the sound.
	Changing the volume and pan	
	LEV	Changes the volume level.
	PAN	Changes the pan.
	Changing how the effects are applied	
	DRY	Changes the volume of the original sound.
	CHO	Changes the amount of chorus.
	REV	Changes the amount of reverb.
	Applying LFO to modulate sounds	
	PIT-LFO1, 2	Changes the vibrato depth.
	TVF-LFO1, 2	Changes the wah depth.
	TVA-LFO1, 2	Changes the tremolo depth.
	PAN-LFO1, 2	Changes the effect that the LFO will have on pan.
	LFO-RATE	Changes the speed of the LFO cycles. The speed will not change if LFO Rate is set to "note."
	Changing the Pitch Envelope	
	PIT-ATK	Changes the Env Time 1 of the pitch envelope.
	PIT-DCY	Changes the Env Time 2 and Env Time 3 of the pitch envelope.
	PIT-REL	Changes the Env Time 4 of the pitch envelope.
	Changing the TVF Envelope	
	TVF-ATK	Changes the Env Time 1 of the TVF envelope.
	TVF-DCY	Changes the Env Time 2 and Env Time 3 of the TVF envelope.
	TVF-REL	Changes the Env Time 4 of the TVF envelope.
	Changing the TVA Envelope	
	TVA-ATK	Changes the Env Time 1 of the TVA envelope.
	TVA-DCY	Changes the Env Time 2 and Env Time 3 of the TVA envelope.
	TVA-REL	Changes the Env Time 4 of the TVA envelope.
	Splitting tones that are played	
	TMT	<ul style="list-style-type: none"> • If the Matrix control is used to split tones, set the TMT Velocity Control to "OFF," and the TMT Control Switch to "ON" (p. 7). • If the Matrix control is used to split tones, we recommend setting the Matrix control Sens to "+63." Selecting a lower value may prevent switching of the tones. Furthermore, if you want to reverse the effect, set the value to "-63." • If you want to use matrix control to switch smoothly between tones, use the Velo Fade Lower and Velo Fade Upper (p. 7). The higher the values set, the smoother the switch is between the tones.

Parameter	Value/Explanation	
	Changing the depth of frequency modulation for FXM	
	FXM	
	Changing specific MFX parameters	
MFX1-4	Change the parameter that was specified by MFX Control 1-4 Assign. * If you have not made the necessary settings for using the MFX, the MFX will not be applied even if you attempt to control it as a Matrix control destination.	
Control Sens1-4	Sets the amount of the Matrix Control's effect that is applied. If you wish to modify the selected parameter in a positive (+) direction—i.e., a higher value, toward the right, or faster etc.—from its current setting, select a positive (+) value. If you wish to modify the selected parameter in a negative (-) direction—i.e., a lower value, toward the left, or slower etc.—from its current setting, select a negative (-) value. For either positive or negative settings, greater absolute values will allow greater amounts of change. Set this to "0" if you don't want to apply the effect.	
	-63+63	
	Selects the tone to which the effect is applied when using the Matrix Control.	
Control Switch1-4	OFF	The effect will not be applied.
	ON	The effect will be applied.
	REVS	The effect will be applied in reverse.

Drum Kit Parameters

MEMO

A drum kit consists of a percussion instrument sound (tone) assigned to each key. The tone that's assigned to each key consists of a combination of up to four waves. Drum Kit Edit lets you edit the settings of the tone that's assigned to each key.

COMMON

Parameter	Value/Explanation	
A0–C8 (Tone name)	Specifies the key to which the tone you want to edit is assigned. * You can also press a key to select this.	
Drum Kit Level	Sets the volume of the drum kit. 0–127	
Tone Name	Changes the name (tone name) of the tone that's assigned to the specified key. Refer to "Editing the tone name" (p. 14).	
Assign Type	Sets the way sounds are played when the same key is pressed a number of times.	
	MULTI	Layer the sound of the same keys. Even with continuous sounds where the sound plays for an extended time, such as with crash cymbals, the sounds are layered, without previously played sounds being eliminated.
Mute Group	Only one sound can be played at a time when the same key is pressed. With continuous sounds where the sound plays for an extended time, the previous sound is stopped when the following sound is played.	
	SINGLE	Only one sound can be played at a time when the same key is pressed. With continuous sounds where the sound plays for an extended time, the previous sound is stopped when the following sound is played.
Mute Group	On an actual acoustic drum set, an open hi-hat and a closed hi-hat sound can never occur simultaneously. To reproduce the reality of this situation, you can set up a Mute Group. The Mute Group function allows you to designate two or more tones that are not allowed to sound simultaneously. Up to 31 Mute Groups can be used. Tones that are not belong to any such group should be set to "OFF." OFF, 1–31	
Tone Env Mode	When a loop waveform (p. 12) is selected, the sound will normally continue as long as the key is pressed. If you want the sound to decay naturally even if the key remains pressed, set this to "NO-SUS." * If a one-shot type waveform (p. 12) is selected, it will not sustain even if this parameter is set to "SUSTAIN." NO-SUS, SUSTAIN	
Tone Pitch Bend Range	Specifies the amount of pitch change in semitones (4 octaves) that will occur when the pitch bend lever is moved. The amount of change when the lever is tilted is set to the same value for both left and right sides. 0–48	
Tone Rx Expression	For each tone, specify whether MIDI Expression messages will be received (ON), or not (OFF). OFF, ON	
Tone Rx Hold-1	For each tone, specify whether MIDI Hold-1 messages will be received (ON), or not (OFF). * If "NO-SUS" is selected for Tone Env Mode (p. 14), this setting will have no effect. OFF, ON	
Rx Pan Mode	For each tone, specify how pan messages will be received. * The channels cannot be set so as not to receive Pan messages.	
	CONT	Whenever Pan messages are received, the stereo position of the tone will be changed.
One Shot Mode	The pan of the tone will be changed only when the next note is played. If a pan message is received while a note is sounding, the panning will not change until the next key is pressed.	
	K-ON	The pan of the tone will be changed only when the next note is played. If a pan message is received while a note is sounding, the panning will not change until the next key is pressed.
One Shot Mode	The sound will play back until the end of the waveform (or the end of the envelope, whichever comes first). The result will be the same as when the envelope's Tone Env Mode (p. 14) is set to "NO-SUS." OFF, ON	

Editing the tone name

1. Move the cursor to "Tone Name," and press the [ENTER] button.
The DRUM KIT TONE NAME screen appears.

2. Assign a tone name

Operation	Explanation
[◀] [▶] buttons	Move the cursor.
Value dial, [-] [+] buttons	Select the character.
[▼] [▲] buttons	Switch between uppercase and lowercase.

Inserting/Deleting Characters

1. While entering a name, press the [MENU] button.
The NAME MENU window appears. The window closes if you press the button once again.
2. Move the cursor to "INSERT" or "DELETE," and press the [ENTER] button.

Function	Explanation
INSERT	Press the [ENTER] button to insert a space (blank) at the cursor location.
DELETE	Press the [ENTER] button to delete the character at the cursor location; subsequent characters will be moved forward to fill the gap.

3. When you've specified the name, press the [ENTER] button.

WAVE

Parameter	Value/Explanation	
<input type="checkbox"/> 1– <input type="checkbox"/> 4	Specify the on/off status of tones 1–4. If a tone is on, a "✓" mark is shown. OFF, ON	
Wave Group	Select the groups containing the Waves comprising the tone.	
	INTA, B	Waveforms stored in internal
	EXP	Waveforms for expansion sounds
	SAMP	Imported user sample waveforms
MSAM	Multisamples created by JUNO-DS Tone Manager (PC software)	
Wave No. L (Mono) Wave No. R	Selects the Waves comprising the tone. Along with the Wave number, the Wave name appears at the lower part of the display. When in mono, only the left side (L) is specified. When in stereo, the right side (R) is also specified. OFF, 1–2402 (The upper limit will depend on the wave group.)	
Wave Gain	Sets the gain (amplification) of the waveform. The value changes in 6 dB (decibel) steps—an increase of 6 dB doubles the waveform's gain. -6, 0, +6, +12	
Wave Tempo Sync	When you wish to synchronize a Phrase Loop to the clock (tempo), set this to "ON." OFF, ON	
Wave FXM Switch	Sets whether FXM will be used (ON) or not (OFF). OFF, ON	
Wave FXM Color	Specifies how FXM will perform frequency modulation. Higher settings result in a grainier sound, while lower settings result in a more metallic sound. 1–4	
Wave FXM Depth	Specifies the depth of the modulation produced by FXM. 0–16	
Wave Coarse Tune	Adjusts the pitch of the waveform's sound up or down in semitone steps (±4 octaves). -48–+48	
Wave Fine Tune	Adjusts the pitch of the waveform's sound up or down in 1-cent steps (±50 cents). -50–+50	
Wave Level	Sets the volume of the waveform. 0–127	
Wave Pan	Specifies the pan of the waveform. "L64" is far left, "0" is center, and "63R" is far right. L64–0–63R	
Wave Random Pan Sw	Use this setting to cause the waveform's panning to change randomly each time a key is pressed (ON) or not (OFF). * The range of the panning change is set by the Random Pan Depth (p. 16). OFF, ON	
Wave Alter Pan Sw	This setting causes panning of the waveform to be alternated between left and right each time a key is pressed.	
	OFF	Pan does not change.
	ON	The waveform is panned according to the Alternate Pan Depth (p. 16) setting.
REVS	The waveform is panned in reverse.	

WMT

Parameter	Value/Explanation	
WMT Velocity Control	WMT Velocity Control determines whether a different tone is played or not depending on the force with which the key is played (velocity).	
	OFF	Waveforms are not velocity-switched.
	ON	Waveforms are switched according to the keyboard playing velocity.
Velo Fade Upper, Lower	RANDOM The waveform's constituent tones will sound randomly, regardless of the velocity.	
	This determines what will happen to the tone's level when the tone is played at a velocity Upper/lower than its specified velocity range. Higher settings produce a more gradual change in volume. If you want notes played outside the specified key velocity range to not be sounded at all, set this to "0." 0–127	
Velo Range Upper, Lower	This sets the highest/lowest velocity at which the waveform will sound. Make these settings when you want different waveforms to sound in response to notes played at different strengths. * If you attempt to set the Lower velocity limit above the Upper, or the Upper below the Lower, the other value will automatically be adjusted to the same setting. (Upper) LOWER–127, (Lower) 1–UPPER	

Parameter	Value/Explanation

PITCH

Parameter	Value/Explanation
Tone Coarse Tune	Selects the pitch at which a tone sounds. C -G9
Tone Fine Tune	Adjusts the pitch of the tone's sound up or down in 1-cent steps (± 50 cents). -50+50
Tone Random Pitch Depth	Specifies the width of random pitch deviation that will occur each time a key is pressed. If you do not want the pitch to change randomly, set this to "0." These values are in units of cents (1/100th of a semitone). 0-1200

PITCH ENV

Parameter	Value/Explanation
Pitch Env Depth	Adjusts the effect of the Pitch Envelope. Higher settings will cause the pitch envelope to produce greater change. Negative (-) settings will invert the shape of the envelope. -12+12
Pitch Env V-Sens	Keyboard playing dynamics can be used to control the depth of the pitch envelope. If you want the pitch envelope to have more effect for strongly played notes, set this parameter to a positive (+) value. If you want the pitch envelope to have less effect for strongly played notes, set this to a negative (-) value. -63+63
Pitch Env T1 V-Sens	This allows keyboard dynamics to affect the Time 1 of the Pitch envelope. If you want Time 1 to be speeded up for strongly played notes, set this parameter to a positive (+) value. If you want it to be slowed down, set this to a negative (-) value. -63+63
Pitch Env T4 V-Sens	Use this parameter when you want key release speed to affect the Time 4 value of the pitch envelope. If you want Time 4 to be speeded up for quickly released notes, set this parameter to a positive (+) value. If you want it to be slowed down, set this to a negative (-) value. -63+63
Pitch Env Time 1-4	Specify the pitch envelope times (Time 1-Time 4). Higher settings will result in a longer time until the next pitch is reached. (For example, Time 2 is the time over which the pitch changes from Level 1 to Level 2.) 0-127
Pitch Env Level 0-4	Specify the pitch envelope levels (Level 0-Level 4). It determines how much the pitch changes from the reference pitch (the value set with Coarse Tune or Fine Tune on the Patch screen) at each point. Positive (+) settings will cause the pitch to be higher than the standard pitch, and negative (-) settings will cause it to be lower. -63+63

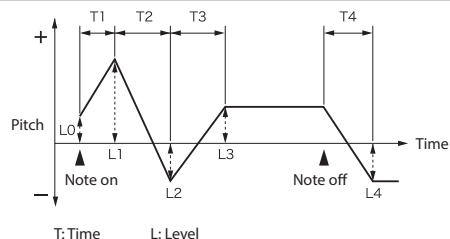

TVF

Parameter	Value/Explanation
	Selects the type of filter. A filter cuts or boosts a specific frequency region to change a sound's brightness, thickness, or other qualities. * If you set "LPF2" or "LPF3," the setting for the Resonance will be ignored (p. 15).
Filter Type	<p>OFF No filter is used.</p> <p>LPF Low Pass Filter. This reduces the volume of all frequencies above the cutoff frequency in order to round off, or un-brighten the sound. This is the most common filter used in synthesizers.</p> <p>BPF Band Pass Filter. This leaves only the frequencies in the region of the cutoff frequency, and cuts the rest. This can be useful when creating distinctive sounds.</p> <p>HPF High Pass Filter. This cuts the frequencies in the region below the cutoff frequency. This is suitable for creating percussive sounds emphasizing their higher tones.</p> <p>PKG Peaking Filter. This emphasizes the frequencies in the region of the cutoff frequency. You can use this to create wah-wah effects by employing an LFO to change the cutoff frequency cyclically.</p> <p>LPF2 Low Pass Filter 2. Although frequency components above the cutoff frequency are cut, the sensitivity of this filter is half that of the LPF. This makes it a comparatively warmer low pass filter. This filter is good for use with simulated instrument sounds such as the acoustic piano.</p> <p>LPF3 Low Pass Filter 3. Although frequency components above the cutoff frequency are cut, the sensitivity of this filter changes according to the cutoff frequency. While this filter is also good for use with simulated acoustic instrument sounds, the nuance it exhibits differs from that of the LPF2, even with the same TVF Envelope settings.</p>
Cutoff Frequency	Selects the frequency at which the filter begins to have an effect on the waveform's frequency components. "LPF/LPF2/LPF3" selected for the Filter Type Lower cutoff frequency settings reduce a tone's upper harmonics for a more rounded, warmer sound. Higher settings make it sound brighter. "BPF" selected for the Filter Type Harmonic components will change depending on the TVF Cutoff Frequency setting. This can be useful when creating distinctive sounds. "HPF" selected for the Filter Type Higher Cutoff Frequency settings will reduce lower harmonics to emphasize just the brighter components of the sound. "PKG" selected for the Filter Type The harmonics to be emphasized will vary depending on Cutoff Frequency setting. 0-127
Resonance	Emphasizes the portion of the sound in the region of the cutoff frequency, adding character to the sound. Excessively high settings can produce oscillation, causing the sound to distort. 0-127
Cutoff V-Curve	Selects one of the following seven curves that determine how keyboard playing dynamics (velocity) influence the cutoff frequency. Set this to "FIXED" if you don't want the Cutoff frequency to be affected by the keyboard velocity. FIXED, 1-7
Cutoff V-Sens	Use this parameter when changing the cutoff frequency to be applied as a result of changes in playing velocity. If you want strongly played notes to raise the cutoff frequency, set this parameter to positive (+) settings. If you want strongly played notes to lower the cutoff frequency, use negative (-) settings. -63+63
Resonance V-Sens	This allows keyboard velocity to modify the amount of Resonance. If you want strongly played notes to have a greater Resonance effect, set this parameter to positive (+) settings. If you want strongly played notes to have less Resonance, use negative (-) settings. -63+63

TVF ENV

Parameter	Value/Explanation
TVF Env Depth	Specifies the depth of the TVF envelope. Higher settings will cause the TVF envelope to produce greater change. Negative (-) settings will invert the shape of the envelope. -63+63
TVF Env V-Curve	Selects one of the following 7 curves that will determine how keyboard playing dynamics will affect the TVF envelope. Set this to "FIXED" if you don't want the TVF Envelope to be affected by the keyboard velocity. FIXED, 1-7 
TVF Env V-Sens	Specifies how keyboard playing dynamics will affect the depth of the TVF envelope. Positive (+) settings will cause the TVF envelope to have a greater effect for strongly played notes, and negative (-) settings will cause the effect to be less. -63+63
TVF Env T1 V-Sens	This allows keyboard dynamics to affect the Time 1 of the TVF envelope. If you want Time 1 to be speeded up for strongly played notes, set this parameter to a positive (+) value. If you want it to be slowed down, set this to a negative (-) value. -63+63
TVF Env T4 V-Sens	The parameter to use when you want key release speed to control the Time 4 value of the TVF envelope. If you want Time 4 to be speeded up for quickly released notes, set this parameter to a positive (+) value. If you want it to be slowed down, set this to a negative (-) value. -63+63
TVF Env Time 1-4	Specify the TVF envelope times (Time 1-Time 4). Higher settings will lengthen the time until the next cutoff frequency level is reached. (For example, Time 2 is the time over which Level 1 will change to Level 2.) 0-127
TVF Env Level 0-4	Specify the TVF envelope levels (Level 0-Level 4). These settings specify how the cutoff frequency will change at each point, relative to the standard cutoff frequency (the cutoff frequency value specified in the TVF screen). 0-127

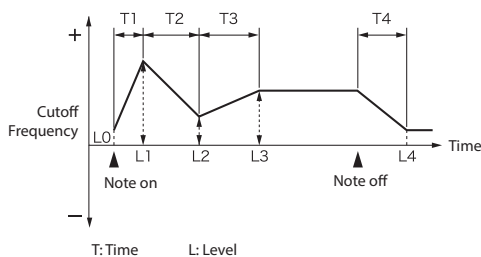

TVA

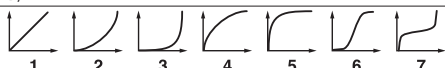
Parameter	Value/Explanation
Tone Level	Sets the volume of the tone. Use this parameter to adjust the volume balance between tones. 0-127
Level V-Curve	You can select from seven curves that determine how keyboard playing strength will affect the volume. If you do not want the volume of the tone to be affected by the force with which you press the key, select "FIXED." FIXED, 1-7 
Level V-Sens	Set this when you want the volume of the tone to change depending on the force with which you press the keys. Set this to a positive (+) value to have the changes in tone volume increase the more forcefully the keys are played; to make the tone play more softly as you play harder, set this to a negative (-) value. -63+63
Tone Pan	Sets the pan for the tone. "L64" is far left, "0" is center, and "63R" is far right. L64-0-63R
Random Pan Depth	Use this parameter when you want the stereo location to change randomly each time you press a key. Higher settings will produce a greater amount of change. * This will affect only waves whose Wave Random Pan Sw (p. 14) is "ON." 0-63
Alternate Pan Depth	This setting causes panning to be alternated between left and right each time a key is pressed. Higher settings will produce a greater amount of change. "L" or "R" settings will reverse the order in which the pan will alternate between left and right. For example if two tones are set to "L" and "R" respectively, the panning of the two tones will alternate each time they are played. * This will affect only waves whose Wave Alter Pan Sw (p. 14) is "ON" or "REVS." L63-0-63R

Parameter	Value/Explanation
Relative Level	Corrects for the volume of the tone. This parameter is set by the key-based controller system exclusive message. Normally, you should leave it set to 0. * If the Tone Level is set to 127, the volume will not increase beyond that point. -64+63

TVA-ENV

Parameter	Value/Explanation
TVA-Env T1 V-Sens	This allows keyboard dynamics to affect the Time 1 of the TVA envelope. If you want Time 1 to be speeded up for strongly played notes, set this parameter to a positive (+) value. If you want it to be slowed down, set this to a negative (-) value. -63+63
TVA-Env T4 V-Sens	The parameter to use when you want key release speed to control the Time 4 value of the TVA envelope. If you want Time 4 to be speeded up for quickly released notes, set this parameter to a positive (+) value. If you want it to be slowed down, set this to a negative (-) value. -63+63
TVA-Env Time 1-4	Specify the TVA envelope times (Time 1-Time 4). Higher settings will lengthen the time until the next volume level is reached. (For example, Time 2 is the time over which Level 1 will change to Level 2.) 0-127
TVA-Env Level 1-3	Specify the TVA envelope levels (Level 1-Level 3). These settings specify how the volume will change at each point, relative to the standard volume (the Tone Level value specified in the TVA screen). 0-127

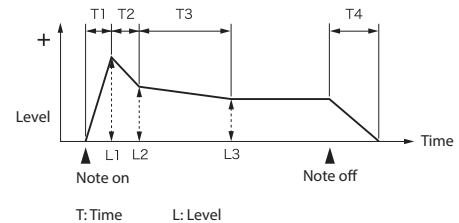

OUTPUT

Parameter	Value/Explanation	
Rhythm Output Assign	MFX	Specifies for each drum kit how the direct sound will be output. Output in stereo through MFX. You can also apply chorus or reverb to the sound that passes through MFX.
	L+R	Output to the OUTPUT L (MONO) jack and OUTPUT R jack in stereo without passing through MFX.
	L, R	Output to the OUTPUT L (MONO) jack or OUTPUT R jack in mono without passing through MFX.
	TONE	Outputs according to the settings for each tone.
Tone Output Assign	Specifies how the direct sound of each tone will be output. * If the Rhythm Output Assign is set to anything other than "TONE," these settings will be ignored. * Chorus and reverb are output in mono at all times.	
	MFX	Output in stereo through MFX. You can also apply chorus or reverb to the sound that passes through MFX.
	L+R	Output to the OUTPUT L (MONO) jack and OUTPUT R jack in stereo without passing through MFX.
Tone Output Level	L, R	Output to the OUTPUT L (MONO) jack or OUTPUT R jack in mono without passing through MFX.
	Set the level of the signal that is sent to the output destination specified by Patch Output Assign or Tone Output Assign. 0-127	
Tone Chorus Send	Specifies the level of the signal sent to the chorus for each tone. 0-127	
Tone Reverb Send	Specifies the level of the signal sent to the reverb for each tone. 0-127	

Effects Edit

In Patch mode you can use multi effects (MFX), chorus, and reverb.

Signal Flow

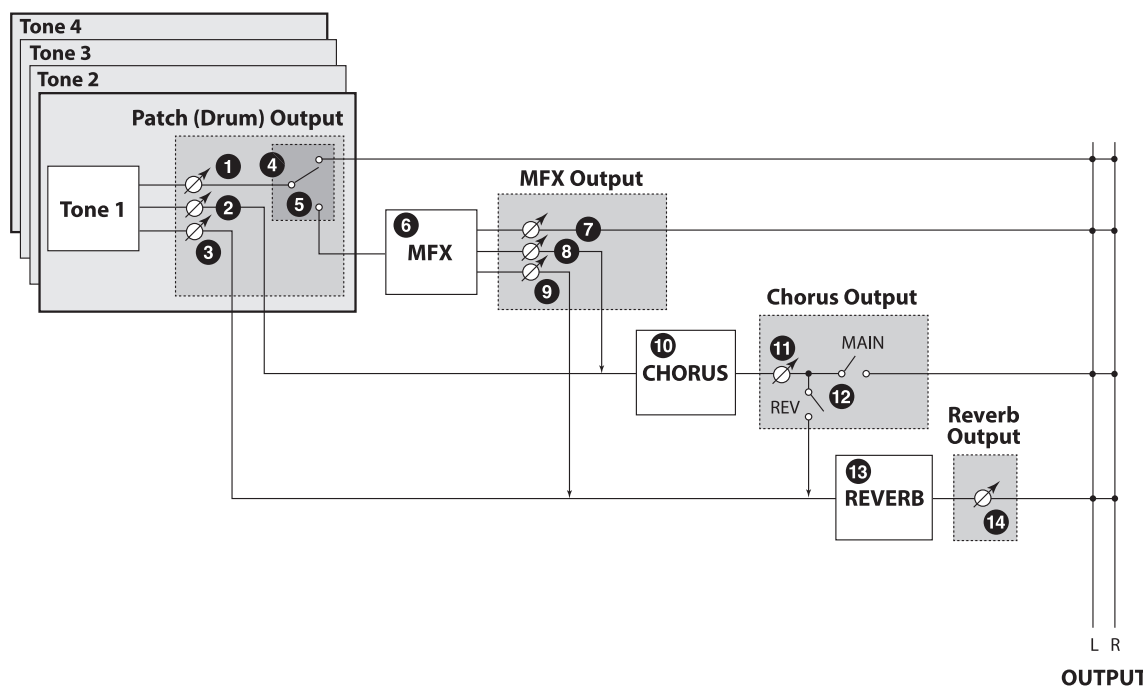

When a patch is selected Make these settings in the "OUTPUT" tab of the PATCH EDIT screen.	1	Tone Output Level	p. 11
	2	Tone Chorus Send	
	3	Tone Reverb Send	
	4	Patch Output Assign	
	5	Tone Output Assign	
When a drum kit is selected Make these settings in the "OUTPUT" tab of the DRUM KIT EDIT screen.	1	Tone Output Level	p. 16
	2	Tone Chorus Send	
	3	Tone Reverb Send	
	4	Rhythm Output Assign	
	5	Tone Output Assign	

Make these settings in the "MFX" tab of the EFFECTS EDIT screen.	6	MFX Type	p. 18
	7	Output Level	
	8	Chorus Send Level	
Make these settings in the "CHORUS" tab of the EFFECTS EDIT screen.	9	Reverb Send Level	p. 18
	10	Chorus Type	
	11	Chorus Level	
Make these settings in the "REVERB" tab of the EFFECTS EDIT screen.	12	Output Select	p. 18
	13	Reverb Type	
	14	Reverb Level	

Procedure

1. Press the [SAMPLE IMPORT] button and [DAW CONTROL] button simultaneously.
The EDIT MENU screen appears.
2. Move the cursor to "EFFECTS EDIT," and press the [ENTER] button.
The EFFECTS EDIT screen appears.
3. Move the cursor to tab, and use the [◀] [▶] buttons to switch the pages.
4. Move the cursor to the parameter that you want to edit, and use the value dial to change the value.
5. To save the edited settings, perform the operation "Saving Your Settings (Write)" (refer to owner's manual).

Effects Parameters

MFX

Parameter	Value/Explanation
MFX Type	Turns MFX on/off, and specifies the type of MFX that is used. If MFX is on, <input type="checkbox"/> shows a "✓" mark. * For details on MFX, refer to "MFX Parameters (MFX, MFX1-3)" (p. 40). 00: THRU-80: BIT CRUSHER
Parameters for each MFX type	Edit the parameters of the MFX type you've selected. * Refer to "MFX Parameters (MFX, MFX1-3)" (p. 40).
Output Level	Adjusts the volume of the sound that has passed through the MFX. If you're applying a MFX, this specifies the depth of the MFX. If you're not applying a MFX, this specifies the volume of the original sound. 0-127
Chorus Send Level	Specifies the level of the signal sent to the chorus. 0-127
Reverb Send Level	Specifies the level of the signal sent to the reverb. 0-127

MFX control

If you wanted to change the volume of MFX sounds, the delay time of Delay, and the like, using an external MIDI device, you would need to send System Exclusive messages-MIDI messages designed exclusively for the JUNO-DS. However, System Exclusive messages tend to be complicated, and the amount of data that needs to be transmitted can get quite large.

For that reason, a number of the more typical of the JUNO-DS's MFX parameters have been designed so they accept the use of Control Change (or other) MIDI messages for the purpose of making changes in their values. For example, you can use the Pitch Bend lever to change the amount of distortion, or use the keyboard's touch to change the delay time of Delay.

The parameters that can be changed are predetermined for each type of MFX; among the parameters described in "MFX parameters" (p. 40), these are indicated by a "#."

The function that allows you use MIDI messages to make these changes in realtime to the MFX parameters is called the MFX control. Up to four MFX controls can be used in a single patch/drum kit/performance.

When the MFX control is used, you can select the amount of control (Sens) applied, the parameter selected (Destination), and the MIDI message used (Source).

MEMO

By using the Matrix control instead of the MFX control, you can also change the parameters of some popular MFX in realtime (p. 12).

MFX CTRL

Parameter	Value/Explanation	
Source 1-4	Sets the MIDI message used to change the MFX parameter with the MFX control.	
	OFF	MFX control will not be used.
	CC01-31, 33-95	Controller numbers 1-31, 33-95
	PITCH BEND	Pitch bend
	AFTERTOUCH	Aftertouch
Destination 1-4	Sets the MFX parameters to be controlled with the Source 1-4. The MFX parameters available for control will depend on the MFX Type. * Refer to "MFX Parameters (MFX, MFX1-3)" (p. 40).	
	Sens 1-4	Specifies the depth of MFX control. Specify a positive (+) value if you want to change the value of the assigned destination in a positive direction (larger, toward the right, faster, etc.), or specify a negative value (-) if you want to change the value in a negative direction (smaller, toward the left, slower, etc.). Larger values will allow a greater amount of control. -63-+63

CHORUS

Parameter	Value/Explanation	
Chorus Type	Turns Chorus on/off, and specifies the type of chorus that is used. If Chorus is on, <input type="checkbox"/> shows a "✓" mark.	
	00: OFF	Neither chorus or delay is used.
	01: CHORUS	Chorus is used.
	02: DELAY	Delay is used.
Parameters for each chorus type	03: GM2 CHORUS	GM2 chorus
	Set the parameters of the selected chorus type. * Refer to "Chorus Parameters" (p. 58).	
Output Select	Specifies how the sound routed through chorus will be output.	
	MAIN	Output to the OUTPUT jacks in stereo.
	REV	Output to reverb in mono.
Chorus Level	M+R	Output to the OUTPUT jacks in stereo, and to reverb in mono.
	Adjusts the volume of the sound that has passed through chorus. 0-127	

REVERB

Parameter	Value/Explanation	
Reverb Type	Turns Reverb on/off, and specifies the type of reverb that is used. If Reverb is on, <input type="checkbox"/> shows a "✓" mark.	
	00: OFF	Reverb is not used.
	01: REVERB	Normal reverb
	02: SRV ROOM	This reverb simulates typical room acoustic reflections.
	03: SRV HALL	This reverb simulates typical concert hall acoustic reflections.
	04: SRV PLATE	This reverb simulates a reverb plate, a popular type of artificial reverb unit that derives its sound from the vibration of a metallic plate.
Parameters for each reverb type	05: GM2 REVERB	GM2 reverb
	Set the parameters of the selected reverb type. * Refer to "Reverb Parameters" (p. 58).	
Reverb Level	Adjusts the volume of the sound that has passed through reverb. 0-127	

Performance Mode

Performance Edit

MEMO

PERFORMANCE EDIT and PART EDIT have the same parameters in common.

Procedure

1. Press the [PATCH/PERFORM] button to make it light.
2. Select a performance that you want to edit.
3. Press the [SAMPLE IMPORT] button and [DAW CONTROL] button simultaneously.
The EDIT MENU screen appears.
4. Move the cursor to "PERFORMANCE EDIT," and press the [ENTER] button.
The PERFORM EDIT screen appears.
5. Move the cursor to tab, and use the [◀] [▶] buttons to switch the pages.
6. Move the cursor to the parameter that you want to edit, and use the value dial to change the value.
7. To save the edited settings, perform the operation "Saving Your Settings (Write)" (refer to owner's manual).

MEMO

- In the PERFORM EDIT screen, you can use pads [1]–[8] to select the part that you want to edit. If you hold down the [SHIFT] button and press a pad [1]–[8], a part 9–16 is selected.
- In the PERFORM EDIT screen, press the [MENU] button to open the INIT MENU window. Select "PERFORM" or "PART" and press the [ENTER] button to initialize the selected performance or part.

Performance Parameters

PATCH

Parameter	Value/Explanation
Type	Sets the assignment of a patch (Pat) or drum kit (Drm) to each of the parts. Pat, Drm
Bank	Selects the group to which the desired patch or drum kit belongs. DS (DS tone), PRST (Preset), GM (GM2 tone), EXP (expansion sounds), USER
Number	Selects the desired patch or drum kit by its number. 0001–
Kbd	Specifies, for each part, whether or not the keyboard controller section will be connected to the internal sound generator. OFF, ON

LEVEL/CH

Parameter	Value/Explanation
Solo	Turns on the part that you want to solo. Parts other than the soloed part are not heard. OFF, ON
Mute	Specifies whether each part's performance is temporarily muted (ON) or not muted (OFF). * The Mute parameter does not turn the part off; it mutes the sound by minimizing the volume. Therefore, the part still receives MIDI messages. OFF, ON
Level	Adjust the volume of each part. This setting's main purpose is to adjust the volume balance between parts. 0–127
Pan	Adjust the pan of each part. "L64" is far left, "0" is center, and "63R" is far right. L64–0–63R
RxCh	Specifies the MIDI receive channel for each part. 1–16
RxSw	For each part, specify whether MIDI messages will be received (ON), or not (OFF). If this is "OFF" the part will not respond. Normally, you should leave this "ON," but you can turn it "OFF" when you do not want a specific part to be playing during song playback. OFF, ON

OUTPUT

Parameter	Value/Explanation
Out	Specifies for each part how the direct sound will be output.
	MFX Output in stereo through MFX. You can also apply chorus or reverb to the sound that passes through MFX.
	L+R Output to the OUTPUT L (MONO) jack and OUTPUT R jack in stereo without passing through MFX.
	L, R Output to the OUTPUT L (MONO) jack or OUTPUT R jack in mono without passing through MFX.
PATCH Outputs according to the settings for patch.	
Sel	Of the three types of MFX that can be used simultaneously, specify which MFX will be used. 1–3 (MFX1–MFX3)
Lev	Set the level of the signal that is sent to the output destination specified by Part Output Assign. 0–127
Cho	Sets the level of the signal sent to chorus for each part. 0–127

Parameter	Value/Explanation
Rev	Sets the level of the signal sent to reverb for each part. 0–127
1–3	Turn MFX 1–3 on/off for each part. If turned on, a "✓" mark appears. Off (–), On (✓)
C	Turn Chorus on/off for each part. If turned on, a "✓" mark appears. Off (–), On (✓)
R	Turn Reverb on/off for each part. If turned on, a "✓" mark appears. Off (–), On (✓)

PITCH

Parameter	Value/Explanation
Oct	Adjusts the pitch of the part's sound up or down in units of an octave (± 3 octaves). * Note that when a rhythm set is assigned to a part, you cannot modify the Octave Shift. –3–+3
Crs	Adjusts the pitch of the part's sound up or down in semitone steps (± 4 octaves). –48–+48
Fine	Adjusts the pitch of the part's sound up or down in 1-cent steps (± 50 cents). –50–+50
Mono	Set this parameter to "MONO" when the patch assigned to the part is to be played monophonically, or to "POLY" when the patch is to be played polyphonically. If you want to use the Mono/Poly setting of the patch assigned to the part (p. 5), set this to "PAT." * This setting is ignored for parts to which a drum kit is assigned. MONO, POLY, PAT
Legt	Turn this parameter "ON" when you want to use the Legato feature and "OFF" when you don't. If you want to use the Legato Switch setting of the patch assigned to the part (p. 5), set this to "PAT." * This setting is ignored for parts to which a drum kit is assigned. OFF, ON, PAT
Bend	Specifies the amount of pitch change in semitones (2 octaves) that will occur when the Pitch Bend Lever is moved. The amount of change when the lever is tilted is set to the same value for both left and right sides. If you want to use the Pitch Bend Range setting of the patch assigned to the part (p. 7), set this to "PAT." 0–24, PAT
Port	Turn this parameter "ON" when you want to apply Portamento and "OFF" when you don't. If you want to use the Portamento Switch setting of the patch assigned to the part (p. 5), set this to "PAT." OFF, ON, PAT
Time	When portamento is used, this specifies the time over which the pitch will change. Higher settings will cause the pitch change to the next note to take more time. If you want to use the Portamento Time setting of the patch assigned to the part (p. 5), set this to "PAT." * This setting is ignored for parts to which a drum kit is assigned. 0–127, PAT

KBD

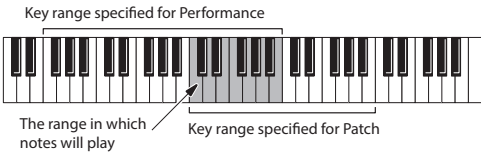
Parameter	Value/Explanation
Kbd	Specifies, for each part, whether or not the keyboard controller section will be connected to the internal sound generator and MIDI OUT. Normally you will leave this off; you can turn it on if you want to layer sounds. OFF, ON
RngLo, RngUp	Specifies the lowest/highest note that the tone will sound for each part. * When the Key Range (p. 7) is set for each individual tone in a patch, sounds are produced in the range where the Key Range of each tone and the Key Range for the part overlap. C- -G9 
V-Sens (Velocity Sensitivity Offset)	This changes the volume and cutoff frequency for each part according to the velocity with which the keys are pressed. If you want strongly played notes to raise the volume/cutoff frequency, set this parameter to positive (+) settings. If you want strongly played notes to lower the volume/cutoff frequency, use negative (-) settings. Set Velocity Sensitivity to "0" when you want sounds played at a fixed volume and cutoff frequency, regardless of the force with which the keys are played. * Patches also contain a Velocity Sensitivity Offset setting (p. 5). The ultimate Velocity Sensitivity Offset value is the sum of the part's and the patch's Velocity Sensitivity Offsets. Accordingly, if the patch's Velocity Sensitivity Offset is set to "127" (maximum), there will be no change in the part's Velocity Sensitivity Offset, even when this is set to a positive value. -63+63
V-Rsv	Specifies the number of voices that will be reserved for each part when more than 128 voices are played simultaneously. * It is not possible for the settings of all parts to total an amount greater than 128. 0-63, FULL
Oct	Adjusts the pitch of the part's sound up or down in units of an octave (± 3 octaves). * Note that when a drum kit is assigned to a part, you cannot modify the Octave Shift. -3+3

Calculating the number of voices being used

The JUNO-DS is able to play up to 128 notes simultaneously. The polyphony, or the number of voices (sounds) does not refer only to the number of sounds actually being played, but changes according to the number of tones used in the patches, and the number of Waves used in the tones. The following method is used to calculate the number of sounds used for one patch being played. (number of sounds being played) x (number of tones used by patches being played) x (number of waves used in the tones) Realtime Stretch requires twice the normal polyphony.

OFFSET

Parameter	Value/Explanation
Cutoff (Cutoff Offset)	Adjusts the cutoff frequency for the patch or drum kit assigned to a part. * Patches also have a Cutoff Offset setting (p. 4). The final cutoff frequency value is the sum of the tone Cutoff Frequency value and the patch and part Cutoff Offset values. If the tone's cutoff frequency is already set to "127" (maximum), there will be no change produced by setting the Cutoff Offset to a positive value. -64+63
Reso (Resonance Offset)	Adjusts the Resonance for the patch or rhythm set assigned to a part. * Patches also have a Resonance Offset setting (p. 4). The final Resonance value is the sum of the tone Resonance value and the patch and part Resonance Offset values. If the tone's resonance is already set to "127" (maximum), there will be no change produced by setting the resonance offset to a positive value. -64+63
Attack (Attack Time Offset)	Adjusts the TVA/TVF Envelope Attack Time for the patch or drum kit assigned to a part. * Patches also contain the Attack Time Offset setting (p. 4). The final TVA Envelope attack time value is therefore the sum of the tone's TVA Envelope Time 1 setting, the patch's Attack Time Offset, and the part's Attack Time Offset. If the tone's Time 1 is already set to "127" (maximum), there will be no change produced by setting the Attack Time Offset to a positive value. The same applies to the TVF envelope. -64+63
Decay	Adjusts the TVA/TVF Envelope Decay Time for the patch or drum kit assigned to a part. -64+63
Release (Release Time Offset)	Adjusts the TVA/TVF Envelope Release Time for the patch or drum kit assigned to a part. * Patches also contain a Release Time Offset setting (p. 4). The final TVA Envelope release time value is therefore the sum of the tone's TVA Envelope Time 4 setting, the patch's Release Time Offset, and the part's Release Time Offset. If the tone's Time 4 is set to "127" (maximum), there will be no change in the Release Time Offset, even when this is set to a positive value. The same applies to the TVF envelope. -64+63

VIBRATO

Parameter	Value/Explanation
Rate	For each part, adjust the vibrato speed (the rate at which the pitch is modulated). The pitch will be modulated more rapidly for higher settings, and more slowly with lower settings. -64+63
Depth	For each part, this adjusts the depth of the vibrato effect (the depth at which the pitch is modulated). The pitch will be modulated more greatly for higher settings, and less with lower settings. -64+63
Delay	For each part, this adjusts the time delay until the vibrato (pitch modulation) effect begins. Higher settings will produce a longer delay time before vibrato begins, while lower settings produce a shorter time. -64+63

SCALE

Parameter	Value/Explanation
C-B	Make scale tune settings for each part. -64+63

Equal Temperament

This tuning divides the octave into 12 equal parts, and is the most widely used method of temperament used in Western music.

Just Temperament (Tonic of C)

Compared with equal temperament, the principle triads sound pure in this tuning. However, this effect is achieved only in one key, and the triads will become ambiguous if you transpose.

Arabian Scale

In this scale, E and B are a quarter note lower and C[♯], F[♯] and G[♯] are a quarter-note higher compared to equal temperament. The intervals between G and B, C and E, F and G[♯], B[♭] and C[♯], and E[♭] and F[♯] have a natural third—the interval between a major third and a minor third. On the JUNO-DS, you can use Arabian temperament in the three keys of G, C and F.

Note name	Equal temperament	Just Temperament (tonic C)	Arabian Scale
C	0	0	-6
C [♯]	0	-8	+45
D	0	+4	-2
E [♭]	0	+16	-12
E	0	-14	-51
F	0	-2	-8
F [♯]	0	-10	+43
G	0	+2	-4
G [♯]	0	+14	+47
A	0	-16	0
B [♭]	0	+14	-10
B	0	-12	-49

MIDI

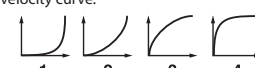
Parameter	Value/Explanation
PC	Program Change
BS	Bank Select
PB	Pitch Bend
PA	Polyphonic Aftertouch
CA	Channel Aftertouch
MD	Modulation
VO	Volume
PN	Pan
EX	Expression
HD	Hold 1
PC-VC	Set PL (phase lock) to "✓" (ON) when you want to suppress discrepancies in timing of parts played on the same MIDI channel. * When the PL (phase lock) is set to "ON," parts on the same MIDI channel are put in a condition in which their timing is matched, enabling them to be played at the same time. Accordingly, a certain amount of time may elapse between reception of the Note messages and playing of the sounds. Turn this setting to "ON" only as needed.
VC	Selects Velocity Curve for each MIDI channel one of the four following Velocity Curve types that best matches the touch of the connected MIDI keyboard. Set this to "—" (OFF) if you are using the MIDI keyboard's own velocity curve. 

Part Edit

MEMO

- PART EDIT and PERFORMANCE EDIT have the same parameters in common.
- If you're using the pattern sequencer, the part edit settings are saved as a "pattern."

Procedure

1. Press the [PATCH/PERFORM] button to make it light.
2. Select a performance that you want to edit.
3. Press the [SAMPLE IMPORT] button and [DAW CONTROL] button simultaneously.
The EDIT MENU screen appears.
4. Move the cursor to "PART EDIT," and press the [ENTER] button.
The PART EDIT screen appears.
5. Move the cursor to tab, and use the [◀] [▶] buttons to switch the pages.
6. Move the cursor to the parameter that you want to edit, and use the value dial to change the value.
7. To save the edited settings, perform the operation "Saving Your Settings (Write)" (refer to owner's manual).

MEMO

- In the PART EDIT screen, you can use pads [1]–[8] to select the part that you want to edit. If you hold down the [SHIFT] button and press a pad [1]–[8], a part 9–16 is selected.

Performance Parameters

PATCH

Parameter	Value/Explanation
TYPE	Sets the assignment of a patch (Patch) or drum kit (Drum) to each of the parts. Patch, Drum
BANK	Selects the group to which the desired patch or drum kit belongs. DS (DS tone), PRST (Preset), GM (GM2 tone), EXP (expansion sounds), USER
Category number	Selects the desired patch or drum kit by its number. 0001–

LEVEL/CH

Parameter	Value/Explanation
Solo Switch	Turns on the part that you want to solo. Parts other than the soloed part are not heard. OFF, ON
Mute Switch	Specifies whether each part's performance is temporarily muted (ON) or not muted (OFF). * The Mute parameter does not turn the part off; it mutes the sound by minimizing the volume. Therefore, the part still receives MIDI messages. OFF, ON
Level	Adjust the volume of each part. This setting's main purpose is to adjust the volume balance between parts. 0–127
Pan	Adjust the pan of each part. "L64" is far left, "0" is center, and "63R" is far right. L64–0–63R
Rx Switch	For each part, specify whether MIDI messages will be received (ON), or not (OFF). If this is "OFF," the part will not respond. Normally, you should leave this "ON," but you can turn it "OFF" when you do not want a specific part to be playing during song playback. OFF, ON
Rx Channel	Specifies the MIDI receive channel for each part. * You can't edit this parameter if the [PATTERN SEQUENCER] button is lit. 1–16

OUTPUT

Parameter	Value/Explanation
Output Assign	Specifies for each part how the direct sound will be output.
	MFX Output in stereo through MFX. You can also apply chorus or reverb to the sound that passes through MFX.
	L+R Output to the OUTPUT L (MONO) jack and OUTPUT R jack in stereo without passing through MFX.
	L, R Output to the OUTPUT L (MONO) jack or OUTPUT R jack in mono without passing through MFX.
PAT Outputs according to the settings for patch.	
Output MFX Sel	Of the three types of MFX that can be used simultaneously, specify which MFX will be used. 1–3 (MFX1–MFX3)
Output Level	Set the level of the signal that is sent to the output destination specified by Part Output Assign. 0–127
Cho Send Level	Sets the level of the signal sent to chorus for each part. 0–127
Rev Send level	Sets the level of the signal sent to reverb for each part. 0–127

PITCH

Parameter	Value/Explanation
Octave Shift	Adjusts the pitch of the part's sound up or down in units of an octave (± 3 octaves). * Note that when a rhythm set is assigned to a part, you cannot modify the Octave Shift. –3–+3
Coarse Tune	Adjusts the pitch of the part's sound up or down in semitone steps (± 4 octaves). –48–+48
Fine Tune	Adjusts the pitch of the part's sound up or down in 1-cent steps (± 50 cents). –50–+50
Mono/Poly	Set this parameter to "MONO" when the patch assigned to the part is to be played monophonically, or to "POLY" when the patch is to be played polyphonically. If you want to use the Mono/Poly setting of the patch assigned to the part (p. 5), set this to "PAT." * This setting is ignored for parts to which a drum kit is assigned. MONO, POLY, PAT
Legato Switch	Turn this parameter "ON" when you want to use the Legato feature and "OFF" when you don't. If you want to use the Legato Switch setting of the patch assigned to the part (p. 5), set this to "PAT." * This setting is ignored for parts to which a drum kit is assigned. OFF, ON, PAT
Bend Range	Specifies the amount of pitch change in semitones (2 octaves) that will occur when the Pitch Bend Lever is moved. The amount of change when the lever is tilted is set to the same value for both left and right sides. If you want to use the Pitch Bend Range setting of the patch assigned to the part (p. 7), set this to "PAT." 0–24, PAT
Porta Switch	Turn this parameter "ON" when you want to apply Portamento and "OFF" when you don't. If you want to use the Portamento Switch setting of the patch assigned to the part (p. 5), set this to "PAT." OFF, ON, PAT
Porta Time	When portamento is used, this specifies the time over which the pitch will change. Higher settings will cause the pitch change to the next note to take more time. If you want to use the Portamento Time setting of the patch assigned to the part (p. 5), set this to "PAT." * This setting is ignored for parts to which a drum kit is assigned. 0–127, PAT

KBD

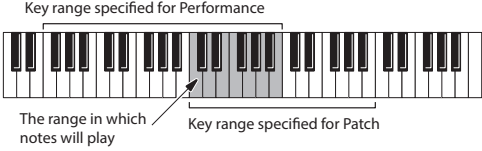
Parameter	Value/Explanation
Kbd Switch	Specifies, for each part, whether or not the keyboard controller section will be connected to the internal sound generator and MIDI OUT. Normally you will leave this off; you can turn it on if you want to layer sounds. OFF, ON
Key Range Lower, Upper	Specifies the lowest/highest note that the tone will sound for each part. * When the Key Range (p. 7) is set for each individual tone in a patch, sounds are produced in the range where the Key Range of each tone and the Key Range for the part overlap. 1-16 
Velo Sens Offset (Velocity Sensitivity Offset)	This changes the volume and cutoff frequency for each part according to the velocity with which the keys are pressed. If you want strongly played notes to raise the volume/cutoff frequency, set this parameter to positive (+) settings. If you want strongly played notes to lower the volume/cutoff frequency, use negative (-) settings. Set Velocity Sensitivity to "0" when you want sounds played at a fixed volume and cutoff frequency, regardless of the force with which the keys are played. * Patches also contain a Velocity Sensitivity Offset setting (p. 5). The ultimate Velocity Sensitivity Offset value is the sum of the part's and the patch's Velocity Sensitivity Offsets. Accordingly, if the patch's Velocity Sensitivity Offset is set to "127" (maximum), there will be no change in the part's Velocity Sensitivity Offset, even when this is set to a positive value. -63+63
Voice Reserve	Specifies the number of voices that will be reserved for each part when more than 128 voices are played simultaneously. * It is not possible for the settings of all parts to total an amount greater than 128. 0-63, FULL
Octave Shift	Adjusts the pitch of the part's sound up or down in units of an octave (±3 octaves). * Note that when a rhythm set is assigned to a part, you cannot modify the Octave Shift. -3+3

Calculating the number of voices being used

The JUNO-DS is able to play up to 128 notes simultaneously. The polyphony, or the number of voices (sounds) does not refer only to the number of sounds actually being played, but changes according to the number of tones used in the patches, and the number of Waves used in the tones. The following method is used to calculate the number of sounds used for one patch being played.
(number of sounds being Played) x (number of tones used by patches being played) x (number of waves used in the tones) Realtime Stretch requires twice the normal polyphony.

OFFSET

Parameter	Value/Explanation
Cutoff Offset	Adjusts the cutoff frequency for the patch or rhythm set assigned to a part. * Patches also have a Cutoff Offset setting (p. 4). The final Cutoff frequency value is the sum of the tone Cutoff Frequency value and the patch and part Cutoff Offset values. If the tone's cutoff frequency is already set to "127" (maximum), there will be no change produced by setting the Cutoff Offset to a positive value. -64+63
Reso Offset (Resonance Offset)	Adjusts the Resonance for the patch or rhythm set assigned to a part. * Patches also have a Resonance Offset setting (p. 4). The final Resonance value is the sum of the tone Resonance value and the patch and part Resonance Offset values. If the tone's resonance is already set to "127" (maximum), there will be no change produced by setting the resonance offset to a positive value. -64+63
Attack Offset (Attack Time Offset)	Adjusts the TVA/TVF Envelope Attack Time for the patch or drum kit assigned to a part. * Patches also contain the Attack Time Offset setting (p. 4). The final TVA Envelope attack time value is therefore the sum of the tone's TVA Envelope Time 1 setting, the patch's Attack Time Offset, and the part's Attack Time Offset. If the tone's Time 1 is already set to "127" (maximum), there will be no change produced by setting the Attack Time Offset to a positive value. The same applies to the TVF envelope. -64+63
Decay Offset	Adjusts the TVA/TVF Envelope Decay Time for the patch or drum kit assigned to a part. -64+63
Release Offset (Release Time Offset)	Adjusts the TVA/TVF Envelope Release Time for the patch or drum kit assigned to a part. * Patches also contain a Release Time Offset setting (p. 4). The final TVA Envelope release time value is therefore the sum of the tone's TVA Envelope Time 4 setting, the patch's Release Time Offset, and the part's Release Time Offset. If the tone's Time 4 is set to "127" (maximum), there will be no change in the Release Time Offset, even when this is set to a positive value. The same applies to the TVF envelope. -64+63

VIBRATO

Parameter	Value/Explanation
Vibrato Rate	For each part, adjust the vibrato speed (the rate at which the pitch is modulated). The pitch will be modulated more rapidly for higher settings, and more slowly with lower settings. -64+63
Vibrato Depth	For each part, this adjusts the depth of the vibrato effect (the depth at which the pitch is modulated). The pitch will be modulated more greatly for higher settings, and less with lower settings. -64+63
Vibrato Delay	For each part, this adjusts the time delay until the vibrato (pitch modulation) effect begins. Higher settings will produce a longer delay time before vibrato begins, while lower settings produce a shorter time. -64+63

SCALE

Parameter	Value/Explanation
C-B	Make scale tune settings for each part. -64+63

Equal Temperament

This tuning divides the octave into 12 equal parts, and is the most widely used method of temperament used in Western music.

Just Temperament (Tonic of C)

Compared with equal temperament, the principle triads sound pure in this tuning. However, this effect is achieved only in one key, and the triads will become ambiguous if you transpose.

Arabian Scale

In this scale, E and B are a quarter note lower and C[♯], F[♯] and G[♯] are a quarter-note higher compared to equal temperament. The intervals between G and B, C and E, F and G[♯], B[♭] and C[♯], and E[♭] and F[♯] have a natural third—the interval between a major third and a minor third. On the JUNO-DS, you can use Arabian temperament in the three keys of G, C and F.

Note name	Equal temperament	Just Temperament (tonic C)	Arabian Scale
C	0	0	-6
C [♯]	0	-8	+45
D	0	+4	-2
E [♭]	0	+16	-12
E	0	-14	-51
F	0	-2	-8
F [♯]	0	-10	+43
G	0	+2	-4
G [♯]	0	+14	+47
A	0	-16	0
B [♭]	0	+14	-10
B	0	-12	-49

MIDI

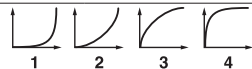
Parameter	Value/Explanation
PC	For each MIDI channel, specify whether MIDI messages will be received (ON), or not (OFF). Assigning a check mark (✓) will enable reception. Program Change
BS	Bank Select
BEND	Pitch Bend
PAFT	Polyphonic Aftertouch
CAFT	Channel Aftertouch
MOD	Modulation
VOL	Volume
PAN	Pan
EXP	Expression
HOLD	Hold 1
VERO CRV	Selects Velocity Curve for each MIDI channel one of the four following Velocity Curve types that best matches the touch of the connected MIDI keyboard. Set this to "OFF" if you are using the MIDI keyboard's own velocity curve. OFF, 1-4 
PHASELOCK	Set PHASELOCK to "ON" when you want to suppress discrepancies in timing of parts played on the same MIDI channel. * When the PHASELOCK is set to "ON", parts on the same MIDI channel are put in a condition in which their timing is matched, enabling them to be played at the same time. Accordingly, a certain amount of time may elapse between reception of the Note messages and playing of the sounds. Turn this setting to "ON" only as needed. OFF, ON

Effects Edit

In Performance mode you can use three multi effects (MFX1–3), one chorus, and one reverb. For each of the three MFX, the chorus, and the reverb, you can specify whether it will operate according to the effect settings of the performance, or according to the effect settings of the patch or drum kit assigned to the part you specify. The three MFX can be used independently, or you can connect two or three of them in series.

Signal Flow

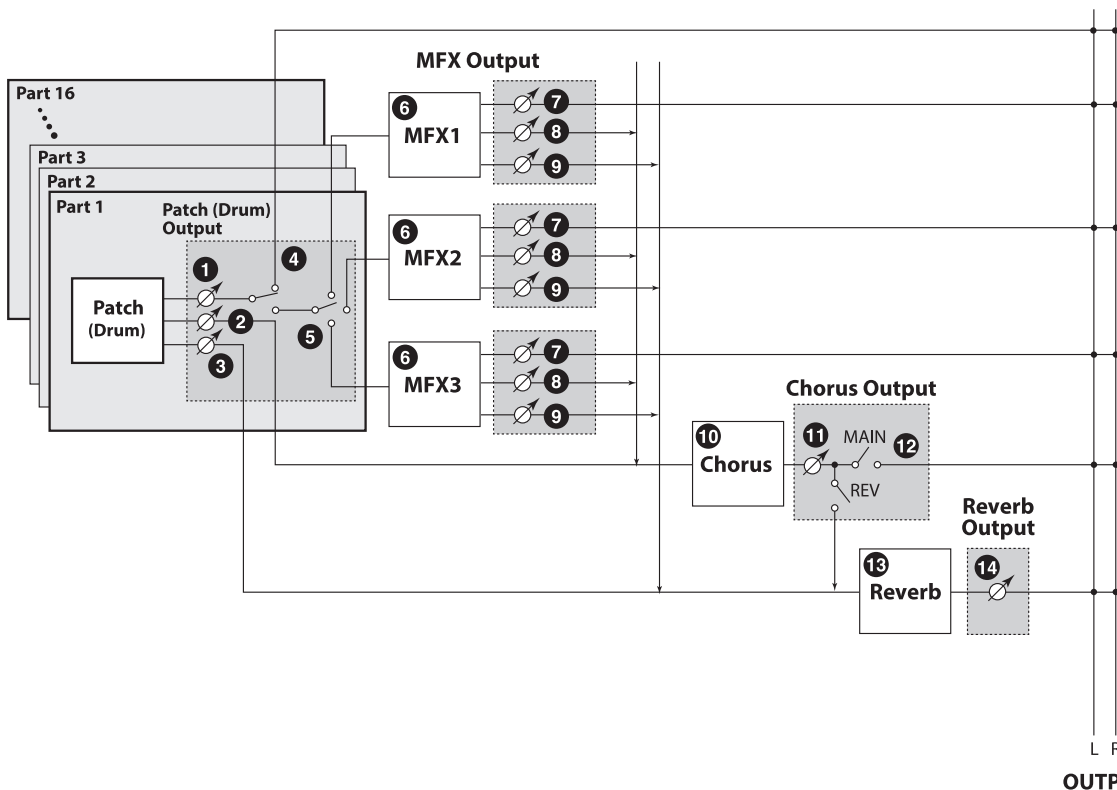

Make these settings in the "OUTPUT" tab of the PART EDIT screen.	1	Output Level	p. 21
	2	Cho Send Level	
	3	Rev Send Send	
	4	Output Assign	
	5	Output MFX Sel	
Make these settings in the "MFX1–3" tab of the EFFECTS EDIT screen.	6	MFX Type	p. 24
	7	Output Level	
	8	Chorus Send Level	
	9	Reverb Send level	

Make these settings in the "CHORUS" tab of the EFFECTS EDIT screen.	10	Chorus Type	p. 24
	11	Chorus Level	
	12	Output Select	
Make these settings in the "REVERB" tab of the EFFECTS EDIT screen.	13	Reverb Type	
	14	Reverb Level	

Procedure

1. Press the [SAMPLE IMPORT] button and [DAW CONTROL] button simultaneously. The EDIT MENU screen appears.
2. Move the cursor to "EFFECTS EDIT," and press the [ENTER] button. The EFFECTS EDIT screen appears.
3. Move the cursor to tab, and use the [◀] [▶] buttons to switch the pages.
4. Move the cursor to the parameter that you want to edit, and use the value dial to change the value.
5. To save the edited settings, perform the operation "Saving Your Settings (Write)" (refer to owner's manual).

Effects Parameters

COMMON

Parameter	Value/Explanation				
MFX Structure	Specify how MFX1–3 will be connected.				
	<table border="0"> <tr> <td>TYPE01</td> <td>TYPE02</td> </tr> <tr> <td></td> <td></td> </tr> </table>	TYPE01	TYPE02		
	TYPE01	TYPE02			
	<table border="0"> <tr> <td>TYPE03</td> <td>TYPE04</td> </tr> <tr> <td></td> <td></td> </tr> </table>	TYPE03	TYPE04		
	TYPE03	TYPE04			
	<table border="0"> <tr> <td>TYPE05</td> <td>TYPE06</td> </tr> <tr> <td></td> <td></td> </tr> </table>	TYPE05	TYPE06		
	TYPE05	TYPE06			
	<table border="0"> <tr> <td>TYPE07</td> <td>TYPE08</td> </tr> <tr> <td></td> <td></td> </tr> </table>	TYPE07	TYPE08		
	TYPE07	TYPE08			
	<table border="0"> <tr> <td>TYPE09</td> <td>TYPE10</td> </tr> <tr> <td></td> <td></td> </tr> </table>	TYPE09	TYPE10		
	TYPE09	TYPE10			
<table border="0"> <tr> <td>TYPE11</td> <td>TYPE12</td> </tr> <tr> <td></td> <td></td> </tr> </table>	TYPE11	TYPE12			
TYPE11	TYPE12				
<table border="0"> <tr> <td>TYPE13</td> <td>TYPE14</td> </tr> <tr> <td></td> <td></td> </tr> </table>	TYPE13	TYPE14			
TYPE13	TYPE14				
<table border="0"> <tr> <td>TYPE15</td> <td>TYPE16</td> </tr> <tr> <td></td> <td></td> </tr> </table>	TYPE15	TYPE16			
TYPE15	TYPE16				
MFX1–3 Source	PERFORM Use the MFX settings of the performance.				
	UPPER (PART1), LOWER (PART2), PART3–16 Use the MFX settings of the patch or drum kit assigned to the specified part				
Chorus Source	PERFORM Use the chorus settings of the performance.				
	UPPER (PART1), LOWER (PART2), PART3–16 Use the chorus settings of the patch or drum kit assigned to the specified part				
Reverb Source	PERFORM Use the reverb settings of the performance.				
	UPPER (PART1), LOWER (PART2), PART3–16 Use the reverb settings of the patch or drum kit assigned to the specified part				

MFX1–3

Parameter	Value/Explanation
MFX Type	Turns MFX on/off, and specifies the type of MFX that is used. If MFX is on, <input type="checkbox"/> shows a "✓" mark. * For details on MFX parameters, refer to "MFX Parameters (MFX, MFX1–3)" (p. 40). 00: THRU–80: BIT CRUSHER
Parameters for each MFX type	Edit the parameters of the MFX type you've selected. * Refer to "MFX Parameters (MFX, MFX1–3)" (p. 40).
Chorus Send Level	Specifies the level of the signal sent to the chorus. 0–127
Reverb Send Level	Specifies the level of the signal sent to the reverb. 0–127

MFX1–3 CTRL

Parameter	Value/Explanation
Source 1–4	Sets the MIDI message used to change the MFX parameter with the MFX control.
	OFF MFX control will not be used.
	CC01–31, 33–95 Controller numbers 1–31, 33–95
	PITCH BEND Pitch bend
	AFTERTOUCH Aftertouch
SYS CTRL1–4 Use the System Control 1–4 Source setting (p. 34).	
Destination 1–4	Sets the MFX parameters to be controlled with the Source1–4. The MFX parameters available for control will depend on the MFX Type. * Refer to "MFX Parameters (MFX, MFX1–3)" (p. 40).
Sens 1–4	Specifies the depth of MFX control. Specify a positive (+) value if you want to change the value of the assigned destination in a positive direction (larger, toward the right, faster, etc.), or specify a negative value (-) if you want to change the value in a negative direction (smaller, toward the left, slower, etc.). Larger values will allow a greater amount of control.
	-63+63

CHORUS

Parameter	Value/Explanation
Chorus Type	Turns Chorus on/off, and specifies the type of chorus that is used. If Chorus is on, <input type="checkbox"/> shows a "✓" mark.
	00: OFF Neither chorus or delay is used.
	01: CHORUS Chorus is used.
	02: DELAY Delay is used.
03: GM2 CHORUS GM2 chorus	
Parameters for each chorus type	Set the parameters of the selected chorus type. The chorus parameters available for control will depend on the Chorus Type. * Refer to "Chorus Parameters" (p. 58).
Output Select	Specifies how the sound routed through chorus will be output.
	MAIN Output to the OUTPUT jacks in stereo.
	REV Output to reverb in mono.
M+R Output to the OUTPUT jacks in stereo, and to reverb in mono.	
Chorus Level	Adjusts the volume of the sound that has passed through chorus. 0–127

REVERB

Parameter	Value/Explanation
Reverb Type	Turns Reverb on/off, and specifies the type of reverb that is used. If Reverb is on, <input type="checkbox"/> shows a "✓" mark.
	00: OFF Reverb is not used.
	01: REVERB Normal reverb
	02: SRV ROOM This reverb simulates typical room acoustic reflections.
	03: SRV HALL This reverb simulates typical concert hall acoustic reflections.
	04: SRV PLATE This reverb simulates a reverb plate, a popular type of artificial reverb unit that derives its sound from the vibration of a metallic plate.
05: GM2 REVERB GM2 reverb	
Parameters for each reverb type	Set the parameters of the selected reverb type. The reverb parameters available for control will depend on the Reverb Type. * Refer to "Reverb Parameters" (p. 58).
Reverb Level	Adjusts the volume of the sound that has passed through reverb. 0–127

Sample Edit

Procedure

1. Press the [SAMPLE IMPORT] button.
The SAMPLE MENU screen appears.
2. Move the cursor to "SAMPLE EDIT" and press the [ENTER] button.
The SAMPLE EDIT screen appears.
3. Move the cursor to tab, and use the [◀] [▶] buttons to switch the pages.
4. Move the cursor to the parameter that you want to edit, and use the value dial to change the value.
5. To save the edited settings, perform the operation "Saving Your Settings (Write)" (refer to owner's manual).

Sample Parameters

SAMPLE

NOTE

The following parameters cannot be edited for samples Sp:001–006 in the PRST bank.

Parameter	Value/Explanation
Original Key	Specifies the note number that plays the sample at the pitch at which it was imported. C-1–G9
Loop Switch	Turns loop playback on/off. OFF, ON
Start	Playback start point (Start Point) (*1) This lets you skip an unwanted portion of the waveform at the beginning of the sample so that the sample plays with the desired timing. 0–
Loop	Point at which the repeated portion starts on the second and subsequent plays (Loop Point) (*1) Specify this if you want to loop from a location other than Start After the Sample played back from Start to End, it will then be repeatedly played back in the forward direction, from the Loop to End. 0–
End	Playback end point (End Point) (*1) This lets you omit an unwanted portion of the waveform at the end of the sample. 0–

(*1)

The length of the imported sample is calculated, and the position of each point is shown as a time (units: milliseconds).

The displayed value (time) is the value when the sample is played at the key specified by Original Key. The playback time is shorter than displayed if you play a key that is higher than the Original Key, and longer than displayed if you play a key that is lower.

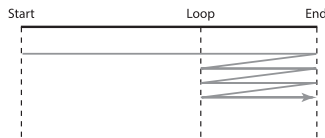

TVF

Parameter	Value/Explanation	
Filter Type	Selects the type of filter. A filter cuts or boosts a specific frequency region to change a sound's brightness, thickness, or other qualities. * If you set "LPF2" or "LPF3", the setting for the Resonance will be ignored (p. 25).	
	OFF	No filter is used.
	LPF	Low Pass Filter. This reduces the volume of all frequencies above the cutoff frequency (Cutoff Freq) in order to round off, or un-brighten the sound. This is the most common filter used in synthesizers.
	BPF	Band Pass Filter. This leaves only the frequencies in the region of the cutoff frequency (Cutoff Freq), and cuts the rest. This can be useful when creating distinctive sounds.
	HPF	High Pass Filter. This cuts the frequencies in the region below the cutoff frequency (Cutoff Freq). This is suitable for creating percussive sounds emphasizing their higher tones.
	PKG	Peaking Filter. This emphasizes the frequencies in the region of the cutoff frequency (Cutoff Freq). You can use this to create wah-wah effects by employing an LFO to change the cutoff frequency cyclically.
Filter Type	LPF2	Low Pass Filter 2. Although frequency components above the Cutoff frequency (Cutoff Freq) are cut, the sensitivity of this filter is half that of the LPF. This makes it a comparatively warmer low pass filter. This filter is good for use with simulated instrument sounds such as the acoustic piano.
	LPF3	Low Pass Filter 3. Although frequency components above the Cutoff frequency (Cutoff Freq) are cut, the sensitivity of this filter changes according to the Cutoff frequency. While this filter is also good for use with simulated acoustic instrument sounds, the nuance it exhibits differs from that of the LPF2, even with the same TVF Envelope settings.
Cutoff Frequency	Selects the frequency at which the filter begins to have an effect on the waveform's frequency components. "LPF/LPF2/LPF3" selected for the Filter Type Lower cutoff frequency settings reduce a tone's upper harmonics for a more rounded, warmer sound. Higher settings make it sound brighter. "BPF" selected for the Filter Type Harmonic components will change depending on the TVF Cutoff Frequency setting. This can be useful when creating distinctive sounds. "HPF" selected for the Filter Type Higher Cutoff Frequency settings will reduce lower harmonics to emphasize just the brighter components of the sound. "PKG" selected for the Filter Type The harmonics to be emphasized will vary depending on Cutoff Frequency setting. 0–127	
Resonance	Emphasizes the portion of the sound in the region of the cutoff frequency, adding character to the sound. Excessively high settings can produce oscillation, causing the sound to distort. 0–127	

Parameter	Value/Explanation
Cutoff Keyfollow	Use this parameter if you want the cutoff frequency to change according to the key that is pressed. Relative to the cutoff frequency at the C4 key (center C), positive (+) settings will cause the cutoff frequency to rise for notes higher than C4, and negative (-) settings will cause the cutoff frequency to fall for notes higher than C4. Larger settings will produce greater change. -200→+200
Cutoff V-Curve	Selects one of the following seven curves that determine how keyboard playing dynamics (velocity) influence the cutoff frequency. Set this to "FIXED" if you don't want the Cutoff frequency to be affected by the keyboard velocity. FIXED, 1-7
Cutoff V-Sens	Use this parameter when changing the cutoff frequency to be applied as a result of changes in playing velocity. If you want strongly played notes to raise the cutoff frequency, set this parameter to positive (+) settings. If you want strongly played notes to lower the cutoff frequency, use negative (-) settings. -63→+63
Resonance V-Sens	This allows keyboard velocity to modify the amount of Resonance. If you want strongly played notes to have a greater Resonance effect, set this parameter to positive (+) settings. If you want strongly played notes to have less Resonance, use negative (-) settings. -63→+63

TVF ENV

Parameter	Value/Explanation
TVF Env Depth	Specifies the depth of the TVF envelope. Higher settings will cause the TVF envelope to produce greater change. Negative (-) settings will invert the shape of the envelope. -63→+63
TVF Env V-Curve	Selects one of the following 7 curves that will determine how keyboard playing dynamics will affect the TVF envelope. Set this to "FIXED" if you don't want the TVF Envelope to be affected by the keyboard velocity. FIXED, 1-7
TVF Env V-Sens	Specifies how keyboard playing dynamics will affect the depth of the TVF envelope. Positive (+) settings will cause the TVF envelope to have a greater effect for strongly played notes, and negative (-) settings will cause the effect to be less. -63→+63
TVF Env T1 V-Sens	This allows keyboard dynamics to affect the Time 1 of the TVF envelope. If you want Time 1 to be speeded up for strongly played notes, set this parameter to a positive (+) value. If you want it to be slowed down, set this to a negative (-) value. -63→+63
TVF Env T4 V-Sens	The parameter to use when you want key release speed to control the Time 4 value of the TVF envelope. If you want Time 4 to be speeded up for quickly released notes, set this parameter to a positive (+) value. If you want it to be slowed down, set this to a negative (-) value. -63→+63
TVF Env Time Keyfollow	Use this setting if you want the TVF envelope times (Time 2–Time 4) to be affected by the keyboard location. Based on the TVF envelope times for the C4 key (center C), positive (+) settings will cause notes higher than C4 to have increasingly shorter times, and negative (-) settings will cause them to have increasingly longer times. Larger settings will produce greater change. -100→+100
TVF Env Time 1-4	Specify the TVF envelope times (Time 1–Time 4). Higher settings will lengthen the time until the next cutoff frequency level is reached. (For example, Time 2 is the time over which Level 1 will change to Level 2.) 0-127
TVF Env Level 0-4	Specify the TVF envelope levels (Level 0–Level 4). These settings specify how the cutoff frequency will change at each point, relative to the standard cutoff frequency (the cutoff frequency value specified in the TVF screen). 0-127

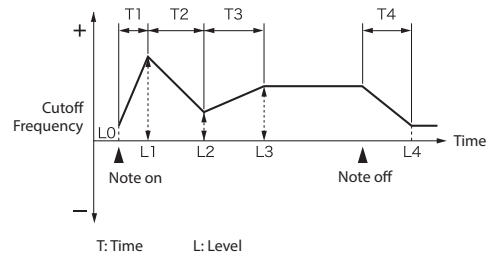

TVA

Parameter	Value/Explanation
Tone Level	Sets the volume of the tone. 0-127
Level V-Curve	You can select from seven curves that determine how keyboard playing strength will affect the volume. If you do not want the volume of the tone to be affected by the force with which you play the key, set this to "FIXED." FIXED, 1-7 
Level V-Sens	Set this when you want the volume of the tone to change depending on the force with which you press the keys. Set this to a positive (+) value to have the changes in tone volume increase the more forcefully the keys are played; to make the tone play more softly as you play harder, set this to a negative (-) value. -63+63
Bias Level	Adjusts the angle of the volume change that will occur in the selected Bias Direction. Larger settings will produce greater change. Negative (-) values will invert the change direction. -100+100
Bias Position	Specifies the key relative to which the volume will be modified. C-1-G9
Bias Direction	LWR The volume will be modified for the keyboard area below the Bias Position.
	UPR The volume will be modified for the keyboard area above the Bias Position.
	L&U The volume will be modified symmetrically toward the left and right of the Bias Position.
	ALL The volume changes linearly with the Bias Position at the center.

Bias

Bias causes the volume to be affected by the keyboard position. This is useful for changing volume through keyboard position (pitch) when playing acoustic instruments.

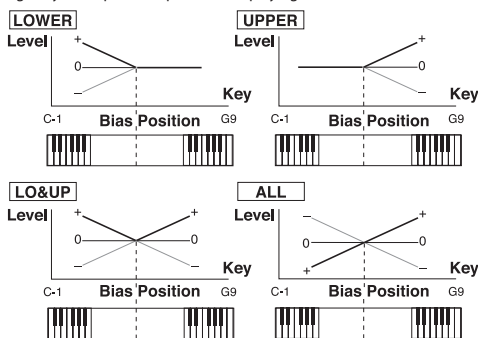

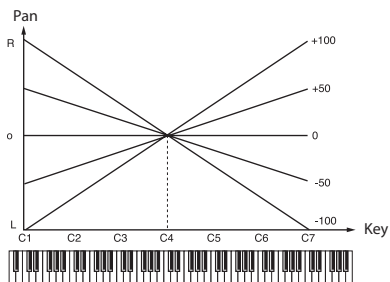
Tone Pan	Sets the pan of the tone. "L64" is far left, "0" is center, and "63R" is far right. L64-0-63R
Pan Keyfollow	Use this parameter if you want key position to affect panning. Positive (+) settings will cause notes higher than C4 key (center C) to be panned increasingly further toward the right, and negative (-) settings will cause notes higher than C4 key (center C) to be panned toward the left. Larger settings will produce greater change. -100+100 
Random Pan Depth	Use this parameter when you want the stereo location to change randomly each time you press a key. Higher settings will produce a greater amount of change. 0-63
Alternate Pan Depth	This setting causes panning to be alternated between left and right each time a key is pressed. Higher settings will produce a greater amount of change. "L" or "R" settings will reverse the order in which the pan will alternate between left and right. L63-0-63R

TVA ENV

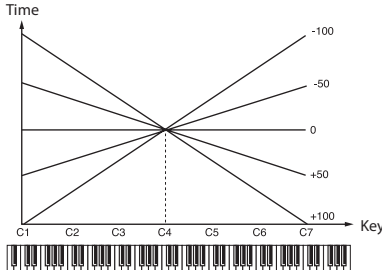
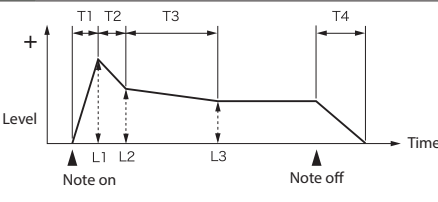
Parameter	Value/Explanation
TVA-Env T1 V-Sens	This allows keyboard dynamics to affect the Time 1 of the TVA envelope. If you want Time 1 to be speeded up for strongly played notes, set this parameter to a positive (+) value. If you want it to be slowed down, set this to a negative (-) value. -63+63
TVA-Env T4 V-Sens	The parameter to use when you want key release speed to control the Time 4 value of the TVA envelope. If you want Time 4 to be speeded up for quickly released notes, set this parameter to a positive (+) value. If you want it to be slowed down, set this to a negative (-) value. -63+63
TVA-Env Time KF	Use this setting if you want the TVA envelope times (Time 2-Time 4) to be affected by the keyboard location. Based on the TVA envelope times for the C4 key (center C), positive (+) settings will cause notes higher than C4 to have increasingly shorter times, and negative (-) settings will cause them to have increasingly longer times. Larger settings will produce greater change. -100+100 
TVA-Env Time 1-4	Specify the TVA envelope times (Time 1-Time 4). Higher settings will lengthen the time until the next volume level is reached. (For example, Time 2 is the time over which Level 1 will change to Level 2.) 0-127
TVA-Env Level 1-3	Specify the TVA envelope levels (Level 1-Level 3). These settings specify how the volume will change at each point, relative to the standard volume (the Tone Level value specified in the TVA screen). 0-127 

LFO1

Parameter	Value/Explanation	
Waveform	Selects the waveform of the LFO. * If you set this to "BD-U" or "BD-D" you must turn the Key Trigger parameter to "ON." If this is "OFF," it will have no effect.	
	SIN	Sine wave
	TRI	Triangle wave
	SAWU	Sawtooth wave
	SAWD	Sawtooth wave (negative polarity)
	SQR	Square wave
	RND	Random wave
	BD-U	Once the attack of the waveform output by the LFO is allowed to develop in standard fashion, the waveform then continues without further change.
	BD-D	Once the decay of the waveform output by the LFO is allowed to develop in standard fashion, the waveform then continues without further change.
	TRP	Trapezoidal wave
	S&H	Sample & Hold wave (one time per cycle, LFO value is changed)
	CHS	Chaos wave
	VSIN	Modified sine wave. The amplitude of a sine wave is randomly varied once each cycle.
	STEP	A waveform generated by the data specified by LFO Step 1-16. This produces stepped change with a fixed pattern similar to a step modulator.
Rate	Adjusts the modulation rate, or speed, of the LFO. * This setting will be ignored if the Waveform is set to "CHS." 0-127, note	
Rate Detune	LFO Rate Detune makes subtle changes in the LFO cycle rate (Rate) each time a key is pressed. Higher settings will cause greater change. * This parameter is invalid when Rate is set to "note." 0-127	

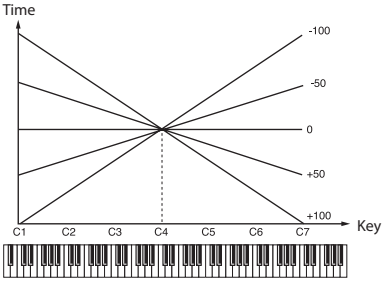
Parameter	Value/Explanation
Offset	Raises or lowers the LFO waveform relative to the central value (pitch or cutoff frequency). Positive (+) settings will move the waveform so that modulation will occur from the central value upward. Negative (-) settings will move the waveform so that modulation will occur from the central value downward. -100, -50, 0, +50, +100
Delay Time	Delay Time (LFO Delay Time) specifies the time elapsed before the LFO effect is applied (the effect continues) after the key is pressed (or released). * After referring to "How to Apply the LFO" (p. 28), change the setting until the desired effect is achieved. 0-127
Delay Time KF	Adjusts the value for the Delay Time depending on the key position, relative to the C4 key (center C). To decrease the time that elapses before the LFO effect is applied (the effect is continuous) with each higher key that is pressed in the upper registers, select a positive value; to increase the elapsed time, select a negative value. Larger settings will produce greater change. If you do not want the elapsed time before the LFO effect is applied (the effect is continuous) to change according to the key pressed, set this to "0." -100-+100 
Fade Mode	Specifies how the LFO will be applied. * After referring to "How to Apply the LFO" (p. 28), change the setting until the desired effect is achieved. ON <, ON >, OFF <, OFF >
Fade Time	Specifies the time over which the LFO amplitude will reach the maximum (minimum). * After referring to "How to Apply the LFO" (p. 28), change the setting until the desired effect is achieved. 0-127
Key Trigger	Specifies whether the LFO cycle will be synchronized to begin when the key is pressed (ON) or not (OFF). OFF, ON
Pitch Depth	Specifies how deeply the LFO will affect pitch. -63-+63
TVF Depth	Specifies how deeply the LFO will affect the cutoff frequency. -63-+63
TVA Depth	Specifies how deeply the LFO will affect the volume. -63-+63
Pan Depth	Specifies how deeply the LFO will affect the pan. -63-+63

STEP LFO

Parameter	Value/Explanation
Step Type	When generating an LFO waveform from the data specified in LFO Step 1-16, specify whether the level will change abruptly at each step (TYPE 1) or will be connected linearly (TYPE 2). TYPE 1, TYPE 2
LFO Step 1-16	Specifies the data for the Step LFO. If the LFO Pitch Depth is +63, each +1 unit of the step data corresponds to a pitch of +50 cents. -36-+36

How to Apply the LFO

Apply the LFO gradually after the key is pressed

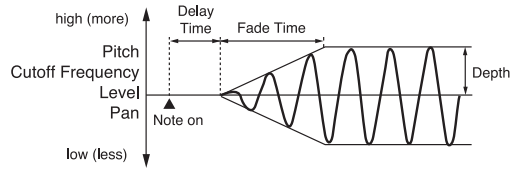

Parameter	Value/Explanation
Fade Mode	ON <
Delay Time	The time from when the keyboard is played until the LFO begins to be applied.
Fade Time	The time over which the LFO amplitude will reach the maximum after the Delay Time has elapsed.

Apply the LFO immediately when the key is pressed, and then gradually begin to decrease the effect

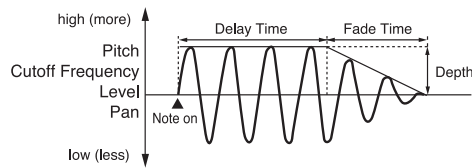

Parameter	Value/Explanation
Fade Mode	ON >
Delay Time	The time that the LFO will continue after the keyboard is played.
Fade Time	The time over which the LFO amplitude will reach the minimum after the Delay Time has elapsed.

Apply the LFO gradually after the key is released

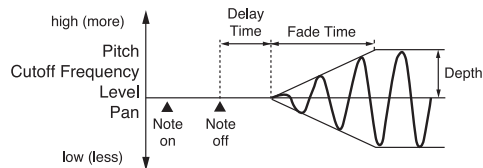

Parameter	Value/Explanation
Fade Mode	OFF <
Delay Time	The time from when the keyboard is released until the LFO begins to be applied.
Fade Time	The time over which the LFO amplitude will reach the maximum after the Delay Time has elapsed.

Apply the LFO from when the key is pressed until it is released, and gradually begin to decrease the effect when the key is released

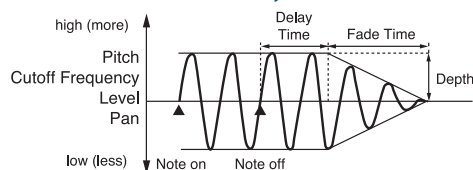

Parameter	Value/Explanation
Fade Mode	OFF >
Delay Time	The time that the LFO will continue after the keyboard is released.
Fade Time	The time over which the LFO amplitude will reach the minimum after the Delay Time has elapsed.

OUTPUT

Parameter	Value/Explanation
Tone Chorus Send	Specifies the level of the signal sent to the chorus. 0-127
Tone Reverb Send	Specifies the level of the signal sent to the reverb. 0-127

Editing Arpeggios

1. Press the [ARPEGGIO] button to make it light.
The ARPEGGIO screen appears.
2. Move the cursor to the item that you want to edit, and use the value dial to edit the setting.
3. Press the [EXIT] button to exit the ARPEGGIO screen.

Parameter	Value/Explanation
STYLE	Selects the arpeggio's basic performance style. 001-128
Part	In performance mode, this selects the part (only one part) that will be played by the arpeggio. If a drum kit is assigned to a part, you can play a drum kit along with the arpeggios. * This parameter is not shown if the patch mode is selected or the [SUPER LAYER] button is on. Part1 (Upper), Part2 (Lower), Part3-16
Arp Hold	You can produce arpeggios even without continuing to press the keyboard. OFF, ON
Grid	Sets the particular note division and resolution in a "single grid" used in creating the arpeggio in an Arpeggio Style, and how much of a "shuffle" syncopation is to be applied (none/weak/strong) to it (grid type). * Grid settings are shared with the rhythm pattern.
	1/4 (♩) Quarter note (one grid section = one beat)
	1/8 (♩) Eighth note (two grid sections = one beat)
	1/8 (♩) L Eighth note shuffle Light (two grid sections = one beat, with a light shuffle)
	1/8 (♩) H Eighth note shuffle Heavy (two grid sections = one beat, with a heavy shuffle)
	1/12 (♩) Eighth note triplet (three grid sections = one beat)
	1/16 (♩) Sixteenth note (four grid sections = one beat)
	1/16 (♩) L Sixteenth note shuffle Light (four grid sections = one beat, with a light shuffle)
	1/16 (♩) H Sixteenth note shuffle Heavy (four grid sections = one beat, with a heavy shuffle)
1/24 (♩) Sixteenth note triplet (six grid sections = one beat)	
Duration	This determines whether the sounds are played staccato (short and clipped), or tenuto (fully drawn out). * Duration settings are shared with the rhythm pattern.
	30-120% For example, when set to "30%," the length of the note in a grid (or when a series of grids is connected with ties, the final grid) is 30% of the full length of the note set in the grid type. Full Even if the linked grid is not connected with a tie, the same note continues to sound until the point at which the next new sound is specified.
Motif	Refer to "Selecting Ascending/Descending Variations (Motif)" (p. 29).
Velocity	Specifies the loudness of the notes that you play.
	REAL The velocity will change according to how strongly you strike the key. 1-127 The notes will be sounded with the velocity you specify here, regardless of how strongly you strike the key.
Oct Range	Adds an effect that shifts arpeggios one cycle at a time in octave units (octave range). You can set the shift range upwards or downwards (up to three octaves up or down). -3+3
Accent	Adjust the amount ("spread") of this dynamic variation. With a setting of "100," the arpeggiated notes will have the velocities that are programmed by the arpeggio style. With a setting of "0," all arpeggiated notes will be sounded at a fixed velocity. 0-100

Selecting Ascending/Descending Variations (Motif)

Selects the method used to play sounds (motif) when you have a greater number of notes than programmed for the Arpeggio Style.

- * When the number of keys played is less than the number of notes in the Style, the highest-pitched of the pressed keys is played by default.

Value	Explanation
Up (L)	Only the lowest of the keys pressed is sounded each time, and the notes play in order from the lowest of the pressed keys.
Up (L&H)	Notes from both the lowest and highest pressed keys are sounded each time, and the notes play in order from the lowest of the pressed keys.
Up ()	The notes play in order from the lowest of the pressed keys. No note is played every time.
Down (L)	Only the lowest of the keys pressed is sounded each time, and the notes play in order from the highest of the pressed keys.
Down (L&H)	Notes from both the lowest and highest pressed keys are sounded each time, and the notes play in order from the highest of the pressed keys.
Down ()	The notes play in order from the highest of the pressed keys. No note is played every time.
U/D (L)	Notes will be sounded from the lowest to the highest key you press and then back down to the lowest key, with only the lowest key sounded each time.
U/D (L&H)	Notes from both the lowest and highest pressed keys are sounded each time, and the notes play in order from the lowest of the pressed keys and then back again in the reverse order.
U/D ()	The notes play in order from the lowest of the pressed keys, and then back again in the reverse order. No note is played every time.
Rand (L)	Notes will be sounded randomly for the keys you press, with only the lowest key sounded each time.
Rand ()	Only the lowest of the keys pressed is sounded each time, the notes you press will be sounded randomly. No note is played every time.
Phrase	Pressing just one key will play a phrase based on the pitch of that key. If you press more than one key, the key you press last will be used.

Editing the Vocoder/Auto Pitch

1. Press the [VOCODER/AUTO PITCH] button to make it light.
The VOCODER/AUTO-PITCH screen appears.



2. Move the cursor to the parameter that you want to edit, and use the value dial to change the value.
3. To save the edited settings, perform the operation "Saving the Vocoder/Auto Pitch Settings (Write)."

Parameter	Value/Explanation
Mode	Selects the vocoder or auto-pitch. Vocoder, Auto-Pitch
Bank, Number	Selects the vocoder or auto-pitch setting. PRST 001-010 Vocoder settings
	PRST 011-020 Auto-pitch settings
	USER 501-520 User settings
Mode: Vocoder	
Carrier	Selects the sound that will be the basic waveform of the vocoder sound.
Level	Adjusts the output level of the sound that passes through the vocoder. 0-127
Pan	Adjusts the stereo position of the sound that passes through the vocoder. L64-63R
Mic Sens	Specifies the input sensitivity of the mic. 0-127
Envelope	Selects the character of the sound. SHARP Emphasizes the human voice.
	SOFT Emphasizes the sound of the instrument.
	LONG Produces a vintage sound with a long decay.
Synth Level	Specifies the input level of the instrumental sound. 0-127
Mic Mix Level	Specifies the amount of the mic audio passing through the Mic HPF (Mic High Pass Filter) that is added to the output of the vocoder. 0-127
Mic HPF	Specifies the frequency at which the high pass filter (HPF) applied to the mic audio starts to take effect. If this is set to "BYPASS," no filter is applied. BYPASS, 1000-16000Hz
Mode: Auto-Pitch	
Keyboard Part	Selects the sound that is played on the keyboard when using Auto-Pitch. Selects how Auto-Pitch correction is performed.
Type	SOFT Corrects the pitch smoothly.
	HARD Corrects the pitch quickly.
	ELECTRIC1 Corrects the pitch in a stepwise manner.
	ELECTRIC2 Corrects the pitch more strongly than ELECTRIC1. This reproduces the mechanical, step-wise pitch correction used in pop music.
	ROBOT Corrects the pitch to the specified note.
Level	Adjusts the output level of the sound that passes through the auto-pitch. 0-127
Pan	Adjusts the stereo position of the sound that passes through auto-pitch. L64-63R
Scale	Selects the scale to which Auto-Pitch corrects the pitch. CHROMATIC Corrects the pitch in semitone steps.
	Maj (Min) Corrects the pitch to the notes of the scale (Key) you specify.
Key	If the Scale parameter is set to "Maj (Min)," specify the key of the song you're singing. For example if the song is in C major, specify "C"; if the song is in A minor, specify "Am."
	C-Bm Relationship between the key of the song and the key signature (and) of the score
	Major keys C F# B# E# A# D# Minor keys Am Dm Gm Cm Fm Bbm Major keys C G D A E B F# Minor keys Am Em Bm F#m C#m C#m D#m
Octave	Makes the pitch one octave higher/lower. -1, 0, +1
Gender	Settings in the "-" direction give the voice an increasingly masculine character; settings in the "+" direction give the voice an increasingly feminine character. -10-+10
Balance	Specifies the volume balance between the direct sound (D) and the effect sound (W). D100:0W-D0:100W
Note	Fixes the pitch. * Available if Type is set to "Robot." C-B

Saving the Vocoder/Auto Pitch Settings (Write)

1. Press the [WRITE] button to make it light.
The VOCODER/AUTO-PITCH NAME screen appears.
2. Assign a name to the data that you're saving.

Operation	Explanation
[◀] [▶] buttons	Move the cursor.
Value dial, [-] [+] buttons	Select the character.
[▼] [▲] buttons	Switch between uppercase and lowercase.

Inserting/Deleting Characters

1. While entering a name, press the [MENU] button.
The NAME MENU window appears. The window closes if you press the button once again.
2. Move the cursor to "INSERT" or "DELETE," and press the [ENTER] button.

Function	Explanation
INSERT	Press the [ENTER] button to insert a space (blank) at the cursor location.
DELETE	Press the [ENTER] button to delete the character at the cursor location; subsequent characters will be moved forward to fill the gap.

3. When you've specified the name, press the [ENTER] button.
4. Use the value dial to specify the save-destination.
5. Press the [ENTER] button.
A confirmation message appears. If you decide to cancel, press the [EXIT] button.
6. Move the cursor to "OK," and press the [ENTER] button.
Saving is complete when the screen indicates "Completed!"

NOTE

Never turn off the power while the screen indicates "Writing..."

Creating an Original Scale (USER SCALE)

You can adjust the pitch of each note from C through B in units of one cent. The pitch you specify for each note is applied to that note for all octaves. You can create and save nine different “user scales” for later recall.

Setting a User Scale

1. Press [MENU] button.
The MENU screen appears.
2. Move the cursor to “USER SCALE,” and press the [ENTER] button.
The USER SCALE screen appears.

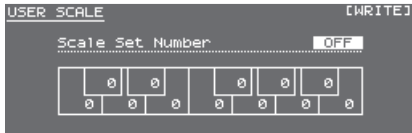

3. Select each of the 12 notes from C to B, and use the value dial to edit their pitch.

* You can also use the keyboard to select a note to edit.

Value -64--+63

Quarter Tone settings

1. In the USER SCALE screen, hold down the OCTAVE [DOWN] button and play a note on the keyboard.
The pitch of the note you played is flattened by 1/4 semitone (-50 cents).
Once again hold down the OCTAVE [DOWN] button and play the same note to restore it to its original pitch.
 2. In the SCALE EDIT screen, hold down the OCTAVE [UP] button and play a note on the keyboard.
The pitch of the note you played is sharpened by 1/4 semitone (+50 cents).
Once again hold down the OCTAVE [UP] button and play the same note to restore it to its original pitch.
4. When you've finished making settings, press the [WRITE] button.
The USER SCALE WRITE screen appears.
* If you press the [EXIT] button to exit the USER SCALE screen without performing the Write operation, the unsaved settings revert to their previous state.
 5. Select the write destination number (USER 1–9), and press the [ENTER] button.
A confirmation message appears.
If you decide to cancel, press the [EXIT] button.
 6. Move the cursor to “OK,” and press the [ENTER] button.
Writing is complete when the screen indicates “User Scale Write Completed.”

Recalling a User Scale

1. Press [MENU] button.
The MENU screen appears.
2. Move the cursor to “USER SCALE,” and press the [ENTER] button.
The USER SCALE screen appears.
The currently selected user scale number is shown.
When the instrument starts up, this always indicates “OFF.”
3. Press the [1]–[9] button to select a user scale.
To return to the normal state (OFF), press the [0] button.

MEMO

- If a user scale is selected, the user scale does not change even if you switch patches or performances.
- User scale returns to OFF when you turn off the power.
- If no user scale is registered to the button that you press, equal temperament is selected.
- If you use the shortcut ([KEY TOUCH]+[TRANPOSE]) to access the USER SCALE screen, you can press a [0]–[9] button to select a user scale and immediately exit the USER SCALE screen. This is convenient when you want to recall a user scale while performing.

System Settings

Procedure

1. Press the [MENU] button.
The MENU screen appears.
2. Move the cursor to "SYSTEM," and press the [ENTER] button.
3. Move the cursor to tab, and use the [◀] [▶] buttons to switch the pages.
4. Move the cursor to the parameter that you want to edit, and use the value dial to change the value.
5. Press the [EXIT] button to exit the screen.

MEMO

The parameters you edit are saved when you press the [WRITE] button in the SYSTEM screen, or when you exit the SYSTEM screen.

System Parameters

GENERAL

Parameter	Value/Explanation
LCD Contrast	Adjusting the display contrast. 1–20
LCD Brightness	Adjusting the display brightness. 1–20
Auto Off	Specifies whether the unit will turn off automatically after a certain time has elapsed. If you don't want the unit to turn off automatically, choose "OFF" setting. OFF, 30, 240[min]
Power Save Time	Amount of idle time that is to pass before the JUNO-DS enters power-save mode. When the JUNO-DS enters power-save mode, it will reduce its power consumption by turning off the display backlight and minimizing button illumination. OFF, 1, 3, 5, 10, 15, 20, 30, 60[min]
Illumination	Specifies whether the buttons illuminate when they are waiting for an operation. OFF, ON

PAD COLOR

Parameter	Value/Explanation
Pad Brightness	Adjusts the brightness of pads [1]–[8]. 1–127
COLOR	The illumination color of pads [1]–[8] can be specified for each function.
Back Ground	Specifies the basic illumination color of the pads.
Level Meter	OFF, 1–13 Specifies the illumination color of the level meter that indicates the volume when you play the keyboard.
Part Select	Specifies the pad illumination color that indicates the selected part when you use the pads to select a part.
Track Select	Specifies the pad illumination color that indicates the selected track when you use the pads to select a track.
Track Data	Specifies the pad illumination color that indicates a track already containing performance data.
Track Mute	Specifies the pad illumination color that indicates a muted track.
Rhythm Pattern	1–13 Specifies the pad illumination color when the RHYTHM PAT TERN screen is displayed.
Audio Player	Specifies the pad illumination color when the AUDIO PLAYER screen is displayed.
Tone Switch	Specifies the pad illumination color for pads [5]–[8] that indicate tones turned on in the PATCH EDIT screen.
Tone Select	Specifies the pad illumination color for the pad that indicates the selected tone in the PATCH EDIT screen.

PAD NOTE

Parameter	Value/Explanation
Pad Note Switch	Specifies the mode in which MIDI note messages are transmitted. OFF Messages are not transmitted. PATCH Only in patch mode. PERFORM Only in performance mode. BOTH In patch mode and in performance mode.
Pad 1–8 Note Number	Specifies the note that is transmitted. C–G9
Pad 1–8 Velocity	Specifies the velocity of the note that is transmitted. OFF, 1–127
Pad 1–8 Channel	Specifies the MIDI channel of the note that is transmitted. 1–16

KEY TOUCH

Parameter	Value/Explanation
Velo Curve	Sets the keyboard's touch. LIGHT, MEDIUM, HEAVY
Curve Offset	Adjusts the Velo Curve. Lower values make the keyboard feel lighter. Higher values make the keyboard feel heavier. -10→+9
Velocity	Specifies the velocity transmitted when a key is played. REAL The transmitted velocity value will correspond to the force with which you strike the key. 1–127 The transmitted velocity value will be fixed, regardless of the force with which you strike the key.

SOUND

Parameter	Value/Explanation
Master Tune	Adjusts the overall tuning of the JUNO-DS. The display shows the frequency of the A4 note (center A). 415.3–466.2[Hz]
Master Key Shift	Shifts the JUNO-DS's overall pitch range in semitone steps. -24→+24
Master Level	Sets the JUNO-DS's overall volume. 0–127
Output Gain	Adjusts the output gain from the JUNO-DS's output. -12→+12[dB]
Audio Level	Specifies the volume when playing audio file from the Audio Player. 0–127

MASTER EQ

Parameter	Value/Explanation
Master EQ Switch	Turn the master EQ (this is an equalizer that is applied to the overall sound of the entire JUNO-DS) on/off. OFF, ON
EQ Low Freq	Frequency of the low range. 200, 400[Hz]
EQ Low Gain	Gain of the low frequency range. -15→+15[dB]
EQ Mid Freq	Frequency of the middle range. 200–8000[Hz]
EQ Mid Gain	Gain of the middle frequency range. -15→+15[dB]
EQ Mid Q	Width of the middle frequency range. Set a higher value for Q to narrow the range to be affected. 0.5, 1.0, 2.0, 4.0, 8.0
EQ High Freq	Frequency of the high range. 2000, 4000, 8000[Hz]
EQ High Gain	Gain of the high frequency range. -15→+15[dB]
EQ Total Gain	Gain of the overall Master EQ. -15→+15[dB]

MIC IN SETTINGS

Parameter	Value/Explanation
Mic In Level	Adjusts the input level of the MIC INPUT jack. 0–127
Mic In Reverb Switch	Specifies whether reverb is applied (ON) to the mic input or not applied (OFF). OFF, ON
Mic In Reverb Level	Adjust the amount of reverb that is applied to the sound of the microphone. 0–127
Mic In Reverb Type	Select the type of reverb/delay that is applied to the sound of the microphone. ROOM1, ROOM2, STAGE1, STAGE2, HALL1, HALL2, DELAY, PAN-DELAY
Mic In Reverb Time	Adjusts the length of the reverberation (when Reverb Type is ROOM1–HALL2) or the delay time of the delay (when Reverb Type is DELAY or PAN-DELAY). 0–127
Noise Suppressor Switch	Switches the noise suppressor on/off. The noise suppressor is a function that suppresses noise during periods of silence. OFF, ON
Noise Suppressor Threshold	Adjusts the volume at which noise suppression starts to be applied. 0–127
Noise Suppressor Release	Adjusts the time from when noise suppression starts until the volume reaches 0. 0–127
Mic Mode	Specifies the mic input mode.
	ALL VOCAL FX

PEDAL

Parameter	Value/Explanation
Control Pedal	
	Specifies the function of the pedal that is connected to the PEDAL CONTROL jack. The number in parentheses () is the controller number of the control change message produced by the pedal when the corresponding function is assigned.
	MODULATION (CC01) Vibrato
	PORTA-TIME (CC05) Portamento time
	VOLUME (CC07) Level
	PAN (CC10) Pan
	EXPRESSION (CC11) Level
	HOLD (CC64) The sound will be sustained for keys that are played or were already held down while holding down the pedal.
	PORTAMENTO (CC65) Portamento switch
	SOSTENUTO (CC66) The sound will be sustained only for keys that were already pressed when you pressed the pedal.
	RESONANCE (CC71) Resonance
	RELEAS-TIME (CC72) Release time
	ATTACK-TIME (CC73) Attack time
	CUTOFF (CC74) Cutoff
	DECAY-TIME (CC75) Decay time
	VIB-RATE (CC76) Vibrato speed
	VIB-DEPTH (CC77) Vibrato depth
	VIB-DELAY (CC78) Vibrato delay time
	CHORUS-SEND (CC93) The amount of the chorus
	REVERB-SEND (CC91) The amount of the reverb
	AFTERTOUCH Channel aftertouch
	* In Patch mode, the effect of the above functions applies to the currently selected sound. In Performance mode, the effect applies to the current part or to parts whose keyboard switch (p. 19, p. 20, p. 22) is on.
	START/STOP Pressing the pedal will start/stop the rhythm pattern, audio player, or pattern sequencer.
	TAP-TEMPO The tempo will be set to the interval at which you press the pedal (Tap Tempo).
	PROG-UP If you're in the patch mode, this selects the next sound. If you're in the performance mode, this selects the next-numbered performance.
	PROG-DOWN If you're in the patch mode, this selects the previous sound. If you're in the performance mode, this selects the previous-numbered performance.
	FAV-UP The favorite of the next number or bank will be selected.
	FAV-DOWN The favorite of the previous number or bank will be selected.
Control Pedal Polarity	Selects the polarity of the pedal connected to the PEDAL CONTROL jack. STANDARD, REVERSE
Hold Pedal	
Continuous Hold Pedal	If this is ON, the PEDAL HOLD jack will support half-pedaling. OFF, ON
Hold Pedal Polarity	Selects the polarity of the pedal connected to the PEDAL HOLD jack. STANDARD, REVERSE

KNOB

Parameter	Value/Explanation	
Knob 1–4 Assign	Specifies the function that is assigned to each knob when the parameter controlled by the control knobs is set to ASSIGN 1–4.	
	OFF	No function is assigned.
	CC01–31, 32 (OFF), 33–95	Controller number 1–31, 32, 33–95
	Pitch Bend	The same effect as moving the pitch bend.
	Aftertouch	Aftertouch
	* In Patch mode, the effect of the above functions applies to the currently selected sound. In Performance mode, the effect applies to the selected part.	
	EQ Low Freq	Frequency of the low range.
	EQ Low Gain	Gain of the low frequency range.
	EQ Mid Freq	Frequency of the middle range.
	EQ Mid Gain	Gain of the middle frequency range.
EQ Mid Q	Width of the middle frequency range.	
EQ High Freq	Frequency of the high range.	
EQ High Gain	Gain of the high frequency range.	

SYNC/TEMPO

Parameter	Value/Explanation
Sync Mode	Specifies the synchronization message that the JUNO-DS will use for operation.
	MASTER SLAVE
Clock Source	When the Sync Mode is "SLAVE," this setting specifies whether the JUNO-DS will synchronize to synchronization messages from the MIDI IN connector or from the USB COMPUTER port. MIDI, USB
Startup Tempo	Specifies the tempo when the JUNO-DS starts. 20–250
Tempo Lock	When you switch performances or patterns, this specifies whether the tempo of the newly selected performance/pattern is used, or the current tempo is maintained. OFF, ON (maintain)

METRONOME

Parameter	Value/Explanation	
Metronome Mode	Specifies how the metronome will be sounded.	
	OFF	No metronome is sounded.
	PLAY-ONLY	The metronome sounds when a pattern is playing.
	REC-ONLY	The metronome sounds when a pattern is being recorded.
	PLAY&REC	The metronome sounds when a pattern is playing or being recorded.
ALWAYS	The metronome sounds at all times.	
Metronome Level	Adjusts the metronome volume. 0–10	
Metronome Sound	Selects the metronome sound.	
	TYPE1	Conventional metronome sound (first beat is a bell)
	TYPE2	Click sound
	TYPE3	Beep sound
TYPE4	Cowbell sound	
Metronome Accent Switch	Adds an accent to the metronome sound. OFF, ON	

MIDI

Parameter	Value/Explanation			
Local Switch	Determines whether the internal sound generator is disconnected (OFF) from the controller section (keyboard, pitch bend/modulation lever, buttons, sliders, pedal, and so on); or not disconnected (ON). Normally you'll leave this "ON." Choose the "OFF" setting if you want operations on the JUNO-DS to only control DAW software on your computer. OFF, ON			
Patch Rx/Tx Ch	In patch mode, specifies the MIDI message transmit/receive channel for the keyboard part. 1-16			
Performance Control Channel	Specifies the MIDI receive channel on which MIDI messages (program change/bank select) from an external MIDI device will be received by the JUNO-DS to switch performances. Choose "OFF" setting if you don't want performances to be switched from a connected MIDI device. 1-16, OFF			
Transmit Program Change, Bank Select, Active Sensing	Specifies whether program change messages/bank select messages/active sensing messages will be transmitted (ON) or not be transmitted (OFF). OFF, ON			
Transmit Edit Data	Specifies whether changes you make in the settings of a patch or performance will be transmitted as system exclusive messages (ON), or will not be transmitted (OFF). OFF, ON			
Receive Program Change, Bank Select	Specifies whether program change messages/bank select messages will be received (ON) or not be received (OFF). OFF, ON			
Soft Through	If this is "ON," incoming MIDI messages from the MIDI IN connector will be re-transmitted without change from the MIDI OUT connector. OFF, ON			
USB Driver	Sets the USB driver. * This setting will take effect when you turn the power off, then on again.			
	<table border="1"> <tr> <td>GENERIC</td> <td>Choose this if you want to use the generic USB driver provided by your computer's operating system.</td> </tr> <tr> <td>VENDOR</td> <td>Choose this if you want to use a USB driver downloaded from the Roland website. (*1)</td> </tr> </table>	GENERIC	Choose this if you want to use the generic USB driver provided by your computer's operating system.	VENDOR
GENERIC	Choose this if you want to use the generic USB driver provided by your computer's operating system.			
VENDOR	Choose this if you want to use a USB driver downloaded from the Roland website. (*1)			

*1: Download the Driver

In order to use the JUNO-DS with the "VENDOR" setting, you must download the driver from the following URL and install it on your computer.
For details on installation, refer to the following URL.

➔ <http://www.roland.com/support/>

CONTROL

Parameter	Value/Explanation	
Sys Ctrl 1-4 Source	Specify the MIDI messages that will be used as system controls. System Control settings allow you to specify MIDI messages that will apply in common to the entire JUNO-DS, and can be used for controlling volume, tone, etc. You can assign up to four MIDI messages for this type of control. * If you want to make assignments for realtime control of the sound and effects for each tone independently, use "Matrix control" (p. 12) or "MFX control" (p. 18).	
	OFF	No function is assigned.
	CC01-31, 32 (OFF), 33-95	Controller number 1-31, 32, 33-95
	PITCH BEND	The same effect as moving the pitch bend.
AFTERTOUC	Aftertouch	

INFORMATION

Parameter	Value/Explanation
Version	View the software version.
Expansion	Displays information about expansion sounds.

Connecting to a Computer via USB

If you use a commercially available USB cable to connect a USB port of your computer to the USB COMPUTER port located on the rear panel of the JUNO-DS, you can use MIDI-compatible software (DAW software) to play back audio and MIDI data on the JUNO-DS.

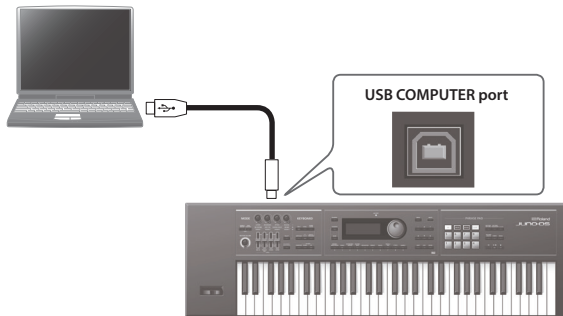

For details on operating requirements, refer to the Roland website.
<http://www.roland.com/support/>

NOTE

- For some types of computer, this might not work correctly. Refer to the Roland website for details on the operating systems that are supported.
- A USB cable is not included. You can purchase one from the dealer where you purchased the JUNO-DS.
- Use a USB 2.0 cable.
- Your computer's USB port must support USB 2.0 Hi-Speed.
- Turn on the power of the JUNO-DS before you start the DAW software on your computer. Don't turn the JUNO-DS's power on/off while your DAW software is running.

USB audio

JUNO-DS → Computer

If the JUNO-DS is connected to your computer via a USB cable, the audio output you've chosen in the JUNO-DS can be recorded into your computer's DAW software.

Computer → JUNO-DS

If the JUNO-DS is connected to your computer via a USB cable, the sound of your computer can be reproduced from an audio system connected to the JUNO-DS's jacks.

USB MIDI

If the JUNO-DS is connected to your computer via a USB cable, the JUNO-DS's performance data (MIDI data) can be recorded into your DAW software, and performance data (MIDI data) played back by your DAW software can be sounded by the JUNO-DS's sound engine.

Installing the USB Driver

The USB driver is software that exchanges data between the JUNO-DS and your computer software. In order to use the JUNO-DS's dedicated USB driver, you must install the USB driver.

MEMO

For details on downloading and installing the USB driver, refer to the Roland website.

<http://www.roland.com/support/>

Making USB Driver Settings

Here's how to switch between the JUNO-DS's dedicated USB driver and the generic driver provided by your operating system.

1. Press the [MENU] button.
The MENU screen appears.
2. Move the cursor to "SYSTEM," and press the [ENTER] button.
The SYSTEM screen appears.
3. Move the cursor to "MIDI" tab – "USB Driver," and use the value dial to select the driver.

Driver	Explanation
VENDOR	The dedicated driver provided by Roland specifically for the JUNO-DS is used. Both MIDI and audio are available.
GENERIC	The generic driver of the operating system is used. Only MIDI is available.

When you switch the driver, a confirmation screen appears. If you decide to cancel, press the [EXIT] button.

4. Move the cursor to "WRITE," and press the [ENTER] button.
Setting is complete when the screen indicates "Completed."

MEMO

This system takes effect when the JUNO-DS is powered-on.

5. Turn the power off, and then on again.

Using the JUNO-DS with DAW Software

Using the JUNO-DS As a DAW Controller

You can use the JUNO-DS as a controller for your DAW software. The JUNO-DS provides various DAW control maps. Simply select the appropriate control map to apply the appropriate settings for the DAW software that you're using.

MEMO

If you want to use the JUNO-DS as a controller for your DAW software, set the USB Driver setting to "VENDOR."

Using the JUNO-DS to Control DAW Software

1. Use a USB cable to connect the JUNO-DS to your computer. A confirmation message appears.
 - * This message is not shown if you power-on the JUNO-DS with it already connected to the computer.
2. Move the cursor to "YES," and press the [ENTER] button. DAW Control mode is on, and the DAW CONTROL screen appears.
3. Move the cursor to "Control Map," and use the value dial to select the DAW software that you're using.

Value	Explanation
LOGIC PRO	When controlling Logic Pro.
SONAR	When controlling SONAR.
CUBASE	When controlling Cubase.
USER	Choose "USER" if your system cannot use the Mackie Control control surface. You'll be able to choose the MIDI messages that are transmitted when you press pads [1]–[8].

4. As necessary, move the cursor to "Sync Output" or "Sync Mode," and use the value dial to change the setting.

Parameter	Value/Explanation			
Sync Output	Specifies whether clock, start, continue, stop, and song position pointer messages are transmitted to another device (ON) or are not transmitted (OFF). <ul style="list-style-type: none"> * When the DAW CONTROL screen is not shown, this parameter is forcibly turned OFF. 			
	OFF, ON			
Sync Mode	Specifies the synchronization message that the JUNO-DS will use for operation.			
	<table border="1"> <tbody> <tr> <td>MASTER</td> <td>The JUNO-DS will be the master. Choose this setting when using the JUNO-DS by itself without synchronizing to another device.</td> </tr> <tr> <td>SLAVE</td> <td>The JUNO-DS will be the slave. Choose this setting when you want the JUNO-DS to synchronize to MIDI Clock messages received from another MIDI device.</td> </tr> </tbody> </table>	MASTER	The JUNO-DS will be the master. Choose this setting when using the JUNO-DS by itself without synchronizing to another device.	SLAVE
MASTER	The JUNO-DS will be the master. Choose this setting when using the JUNO-DS by itself without synchronizing to another device.			
SLAVE	The JUNO-DS will be the slave. Choose this setting when you want the JUNO-DS to synchronize to MIDI Clock messages received from another MIDI device.			

5. Turn the Local Switch "OFF" in the "Controller" tab (p. 37).
6. In your DAW software, open the project file that you want to control.

MEMO

Before you continue, select "JUNO-DS" as the MIDI input device and output device.

For details on how to do this, refer to the owner's manual of your DAW software.

7. Make the appropriate control surface settings for the DAW software you selected.

Settings in LOGIC PRO

This explanation describes the procedure when using Logic Pro X. The procedure may differ for other versions.

1. From the Logic Pro X menu, choose [Logic Pro X] → [Control Surfaces] → [Setup] to open the setting screen.
2. From the menu, choose [New] → [Install].
3. From the list of Model, choose "Mackie Control" and press "Add."
4. As the input port and the output port, specify "JUNO-DS DAW CTRL."

Settings in SONAR

This explanation describes the procedure when using SONAR X2 Producer. The procedure may differ for other versions.

1. From the SONAR menu, choose [Edit] → [Preferences] → [MIDI Devices] to open the input/output device selection.
2. To the input devices and output devices, add "JUNO-DS DAW CTRL."
3. In [Preferences], choose [MIDI Control Surfaces].
4. Press "Add new Controller/Surface" to access the control surface settings dialog box.
5. Choose "Mackie Control" as the control surface, choose "JUNO-DS DAW CTRL" as the input port and output port, and then press "OK."

Settings in CUBASE

This explanation describes the procedure when using the Mac OS X version of Cubase 7. The procedure may differ for other versions.

1. From the Cubase [Devices] menu, choose [Device Setup].
2. Press the [+] button located in the upper left of the dialog box, and choose "Mackie Control" from the pull-down menu.
3. As the MIDI input and MIDI output for Mackie Control, specify "JUNO-DS DAW CTRL."
4. In the left side of the dialog box, choose "MIDI Port Setup" to access the setting screen.
5. In "JUNO-DS DAW CTRL," clear the check box from "In 'ALL MIDI Inputs'."

8. Operate the JUNO-DS to control your DAW software.

Available controllers	Explanation
[▶/■] button	Playback/Stop
[●] button	Start recording on record-standby tracks.
[◀] button	Return the current position to the beginning.
[SHIFT]+Pad [2]	Rewind
[SHIFT]+Pad [3]	Fast forward
The [▶/■] through [◀] buttons emulate the Mackie Control control surface.	
Pad [1]–[8]	Emulate the Mackie Control control surface Function buttons (F1–F8).
Control knobs	You can control the functions that are assigned (p. 33) to Assign 1–4 (p. 37).
[LEVEL] sliders	You can control the functions that are assigned to the four sliders (p. 37).

Assigning Functions to Knobs and Sliders

You can assign functions to the control knobs (1–4) and the [LEVEL] sliders (1–4).

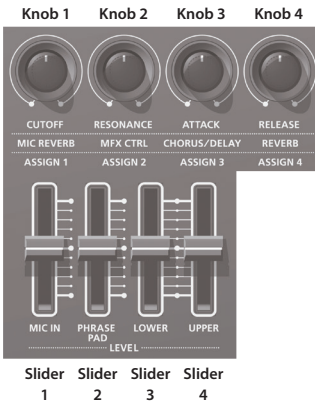

You can store sixteen sets of these assignments, with each set containing the assignments of the control knobs (1–4) and the [LEVEL] sliders (1–4).

1. In the DAW CONTROL screen, select the “Controller” tab.
2. Select the set of assignments that you want to edit.

MEMO

You can press the [ENTER] button and rename the set.

3. Move the cursor to the parameter that you want to edit, and use the value dial to change the value.

Parameter	Explanation
Local Switch	Turns the Local switch on/off when in DAW Control mode. If you're using a DAW software with the JUNO-DS's keyboard controller section and sound generator section, you should turn the Local Switch "OFF". Here's why. We need to connect these sections in the following order: the JUNO-DS's keyboard a DAW software the JUNO-DS's sound generator. Since the JUNO-DS's keyboard section and sound generator section are connected internally, such a connection order would normally be impossible. However, if the Local Switch is "OFF," the JUNO-DS's keyboard section and its sound generator section will be independent, allowing you to use a DAW software as shown here in the illustration.
Tx Channel	Specifies the MIDI transmit channel used when in DAW Control mode. Set this as desired.
Knob 1–4	Select the MIDI messages that are transmitted when you turn the control knobs (1–4).
Slider 1–4	Select the MIDI messages that are transmitted when you control the [LEVEL] sliders (1–4).

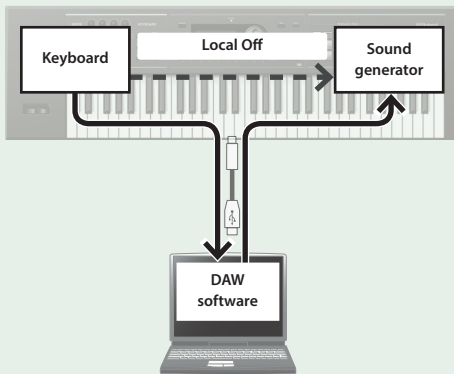

Using the JUNO-DS As a MIDI Keyboard

Your playing on the JUNO-DS's keyboard (MIDI data) can be recorded into your DAW software, or used to play software instruments.

1. Connect the JUNO-DS to your computer.
2. Press the [DAW CONTROL] button to make it light.
The DAW CONTROL screen appears.
3. In the DAW CONTROL screen, select the “Controller” tab.
4. Turn the Local Switch “OFF.”

MEMO

Set the MIDI transmit channel as necessary (Tx Channel: p. 37).

Playing the JUNO-DS's Sound Generator from DAW Software

Performance data (MIDI data) played back by your DAW software can make the JUNO-DS's sound generator produce sound.

1. Connect the JUNO-DS to your computer.
2. Press the [DAW CONTROL] button to make it light.
3. Start your DAW software, and open the project file that you want to play.

MEMO

Before you continue, select “JUNO-DS” as the MIDI input device and output device.

For details on how to make this setting, refer to the owner's manual of your DAW software.

4. In the DAW CONTROL screen, select the “Part Edit” tab.



No.	Explanation
1	Performance
2	Patches that are assigned to each part
3	Receive switch for each part If you set to “OFF,” MIDI messages are not received.
4	Receive channel for each part

* Depending on the channel settings of your DAW, messages that switch studio sets may be transmitted on the channel of a part, causing the tone to switch. If this occurs, check the channel settings of your DAW.

5. Change the settings as necessary.

MEMO

It is convenient to turn receive switch on/off if you temporarily want to stop receiving MIDI messages.

6. In your DAW software, set the transmit channels of the tracks that you're playing back to match the receive channel settings of the JUNO-DS.
For details on how to make this setting, refer to the owner's manual of your DAW software.
7. Play back your DAW software.
You hear the playback sounded by the JUNO-DS's patches.

MEMO

If you want your settings to be remembered, save the DAW CONTROL settings (p. 38).

Using the JUNO-DS As an Audio Interface

The JUNO-DS's audio output you've specified can be recorded into DAW software on your computer. Sound from your computer can also be reproduced from a device that's connected to the JUNO-DS's OUTPUT jacks.

1. Connect the JUNO-DS to your computer.
2. Start up your DAW software, and choose "JUNO-DS" as the audio input device and output device.

For details on how to make this setting, refer to the owner's manual of your DAW software.

Saving the DAW CONTROL Settings

The DAW CONTROL settings revert to their previous state when you turn off the power. If you want the DAW CONTROL settings to be remembered even after power-off, save them.

1. In the DAW CONTROL screen (expect in the "Part Edit" tab), press the [WRITE] button.

* If you press the [WRITE] button when the "Part Edit" tab is selected, PERFORMANCE WRITE is executed.

A confirmation message appears.
If you decide to cancel, press the [EXIT] button.

2. Move the cursor to "OK," and press the [ENTER] button.
Saving is complete when the screen indicates "Completed!"

NOTE

Never turn off the power while the screen indicates "Writing...."

MEMO

When you save the DAW CONTROL settings, the system settings are also saved.

Error Messages

If an incorrect operation is performed, or if processing could not be performed as you specified, an error message appears. Refer to the explanation for the error message that appears, and take the appropriate action.

Message	Meaning	Action
Battery Low!	The battery has run down.	Replace the batteries, or use an AC adaptor.
Cannot Read!	Failed to load the audio file from the USB flash drive.	Make sure that USB flash drive is correctly connected. Use USB Flash Memory sold by Roland.
Duplicate File Name! Overwrite it?	A file of the same name already exists.	If you want to overwrite it, proceed with the operation. If you don't want to delete the identically-named file, save using a different file name.
Duplicate File Name!	A file of the same name already exists.	Check the name.
Format USB Memory Error!	An error occurred when formatting the USB flash drive.	Use USB Flash Memory sold by Roland. We cannot guarantee operation if other products are used.
Incorrect File!	This is a file that the JUNO-DS is unable to play/import.	Do not use this file.
Incorrect File Name!	A "." (period) cannot be used at the beginning of a file name.	Specify a different character.
Int Memory Full!	There is insufficient memory capacity in the internal pattern writing destination.	Delete unneeded pattern.
Memory Damaged!	Failed when reading from the waveform memory file system.	Please execute a Factory Reset. If this does not resolve the problem, contact your dealer or a nearby Roland service center.
Memory Full!	There is insufficient free capacity to store the sample.	Delete unneeded sample.
Memory Full! Optimize?	There is insufficient free capacity to store the sample. Do you want to execute Optimize?	You can obtain free capacity by optimizing the memory area (p. 2).
MIDI Buffer Full!	An unusually large amount of MIDI data was received, and could not be processed.	Reduce the amount of MIDI messages that are being transmitted.
MIDI Offline!	The MIDI IN connection was broken.	Check that there is no problem with the MIDI cable connected to the JUNO-DS's MIDI IN, and that the MIDI cable was not disconnected.
No more Registered Favorites!	No more favorites have been registered.	Check the currently selected favorite number and the direction ("FAV-UP" or "FAV-DOWN") that's assigned to the pedal (p. 33).
No Room!	The number of stored waveforms has reached the maximum (256).	Delete unneeded sample.
Not Found!	The file was not found on the USB flash drive.	Make sure that the file exists on the USB flash drive.
Now Playing!	Since the JUNO-DS is playing, this operation cannot be executed.	Stop playback before you execute the operation.
Now Recording!	Since the JUNO-DS is recording, this operation cannot be executed.	Stop recording before you execute the operation.
Pattern Full!	The maximum number of notes that can be recorded in one pattern has been exceeded; the pattern cannot be recorded any further.	Delete unneeded data from the pattern that you're recording.
	This indication may appear if a large amount of data, such as movements of the Control knobs, is being recorded. No further pattern recording is possible.	
Permission Denied!	The operation cannot be performed because the USB flash drive, file, or folder is write-protected.	Disable the write-protect setting of the USB flash drive. Using your computer, disable the write-protect setting of the file or folder.
Read Error!	Failed to load data from USB flash drive.	Make sure that USB flash drive is correctly connected.
	It may be that the file is damaged.	Do not use this file.
	This file cannot be loaded since its format is incorrect.	
Rec Overflow!	Since a large amount of recorded data was input all at once, it could not be processed correctly.	Reduce the amount of recorded data.
Sample Length Too Long!	The audio file cannot be imported because it is too long.	An audio file that exceeds 64 MB stereo or 32 MB mono cannot be imported.
Sample Length Too Short!	The audio file cannot be imported because it is too short.	Extremely short audio files cannot be imported.
Sys Mem Damaged!	It is possible that the contents of system memory have been damaged.	Please execute a Factory Reset. If this does not resolve the problem, contact your dealer or a nearby Roland service center.
USB Mem NotReady!	USB flash drive is not connected.	Connect USB flash drive.
Write Error!	Failed to write data to USB flash drive.	Make sure that USB flash drive is correctly connected.
	Data cannot be written because the USB flash drive has no more free space.	Delete unneeded files from the USB flash drive. Alternatively, use a different USB flash drive device, one that has more free space available.
	The file or the USB flash drive itself is write protected.	Make sure that the file or the USB flash drive is not write protected.

MFX/Chorus/Reverb Parameters

MFX Parameters (MFX, MFX1-3)

The MFX feature 80 different kinds of effects. Some of the effects consist of two or more different effects connected in series.

Type	MFX	Page	
Filter	00 THRU	-	
	01 EQUALIZER	p. 41	
	02 SPECTRUM		
	03 ISOLATOR		
	04 LOW BOOST		
	05 SUPER FILTER	p. 42	
	06 STEP FILTER		
	07 ENHANCER		
	08 AUTO WAH		
	09 HUMANIZER		
10 SPEAKER SIMULATOR	p. 43		
11 PHASER			
Modulation	12 STEP PHASER	p. 44	
	13 MLT STAGE PHASER		
	14 INFINITE PHASER		
	15 RING MODULATOR		
	16 STEP RING MOD		
	17 TREMOLO		
	18 AUTO PAN	p. 45	
	19 STEP PAN		
	20 SLICER		
	21 ROTARY		
	22 VK ROTARY		
	23 CHORUS		p. 46
24 FLANGER			
25 STEP FLANGER			
26 HEXA-CHORUS			
27 TREMOLO CHORUS			
28 SPACE-D			
29 3D CHORUS	p. 47		
30 3D FLANGER			
31 3D STEP FLANGER	p. 48		
32 2BAND CHORUS			
33 2BAND FLANGER			
34 2BAND STEP FLANGR			
35 OVERDRIVE			
36 DISTORTION			
Dynamics	37 VS OVERDRIVE	p. 49	
	38 VS DISTORTION		
	39 GUITAR AMP SIM		
	40 COMPRESSOR		
	41 LIMITER		
	42 GATE		
	43 DELAY		p. 50
	44 LONG DELAY		
Delay	45 SERIAL DELAY	p. 51	
	46 MODULATION DELAY		
	47 3TAP PAN DELAY		
	48 4TAP PAN DELAY		
	49 MULTI TAP DELAY		
	50 REVERSE DELAY		
	51 SHUFFLE DELAY	p. 52	
	52 3D DELAY		
	53 ANALOG DELAY		
	54 ANALOG LONG DELAY		
Lo-Fi 1	55 TAPE ECHO	p. 53	
	56 LOFI NOISE		
	57 LOFI COMPRESS		
	58 LOFI RADIO		
Pitch	59 TELEPHONE	p. 54	
	60 PHONOGRAPH		
	61 PITCH SHIFTER		
Reverb	62 2VOI PCH SHIFTER	p. 55	
	63 STEP PCH SHIFTER		
	64 REVERB		
	65 GATED REVERB		

Type	MFX	Page
Combination	66 OD → CHORUS	p. 55
	67 OD → FLANGER	
	68 OD → DELAY	p. 56
	69 DST → CHORUS	
	70 DST → FLANGER	
	71 DST → DELAY	
	72 ENH → CHORUS	
	73 ENH → FLANGER	
	74 ENH → DELAY	
	75 CHORUS → DELAY	
76 FLANGER → DELAY		
77 CHORUS → FLANGER	p. 57	
78 SYMPATHETIC RESO		
Piano	79	Di VOCODER
Lo-Fi 2	80	BIT CRUSHER

MEMO

- Parameters marked with a ☆ can be controlled using the control knob to which "MFX CTRL" is assigned.
- Parameters marked with a sharp "#" can be controlled using a MFX control (p. 18, p. 24) or Matrix control (p. 12). (Two setting items will change simultaneously for "#1" and "#2").

Note

Some effect parameters (such as Rate or Delay Time) can be set in terms of a note value.

	Sixty-fourth-note triplet		Sixty-fourth note		Thirty-second-note triplet		Thirty-second note
	Sixteenth-note triplet		Dotted thirty-second note		Sixteenth note		Eighth-note triplet
	Dotted sixteenth note		Eighth note		Quarter-note triplet		Dotted eighth note
	Quarter note		Half-note triplet		Dotted quarter note		Half note
	Whole-note triplet		Dotted half note		Whole note		Double-note triplet
	Dotted whole note		Double note				

NOTE

- If you specify the delay time as a note value, slowing down the tempo will not change the delay time beyond a certain length. This is because there is an upper limit for the delay time; if the delay time is specified as a note value and you slow down the tempo until this upper limit is reached, the delay time cannot change any further. This upper limit is the maximum value that can be specified when setting the delay time as a numerical value.
- If you specify a parameter for which a note value is assigned as the MFX control Destination, you can't use MFX control to control that parameter.

When Using 3D Effects

The following 3D effects utilize RSS (Roland Sound Space) technology to create a spaciousness that cannot be produced by delay, reverb, chorus, etc.

- 52: 3D DELAY
- 29: 3D CHORUS
- 30: 3D FLANGER
- 31: 3D STEP FLANGER

When using these effects, we recommend that you place your speakers as follows. Also, make sure that the speakers are at a sufficient distance from the walls on either side.

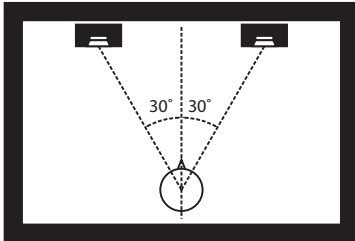

If the left and right speakers are too far apart, or if there is too much reverberation, the full 3D effect may not appear. Each of these effects has an "Output Mode" parameter. If the sound from the OUTPUT jacks is to be heard through speakers, set this parameter to "SPEAKER." If the sound is to be heard through headphones, set it to "PHONES." This will ensure that the optimal 3D effect will be heard. If this parameter is not set correctly, the full 3D effect may not appear.

About the Step Reset function

- 06: STEP FILTER
- 16: STEP RING MOD
- 19: STEP PAN
- 20: SLICER
- 63: STEP PCH SHIFTER

The above types contain a sixteen-step sequencer. For these types, you can use a MFX control to reset the sequence to play from the first step. To do this, set the MFX control Destination to "Step Reset."

For example if you are using the modulation lever to control the effect, you would make the following settings.

Parameter	Value
Source	CC01: Modulation
Destination	Step Reset
Sens	+63

With these settings, the sequence will play back from the first step whenever you operate the modulation lever.

Rotary effect

- 21: ROTARY
- 22: VK ROTARY

When performing sounds that use these effects, you can change the speed of the rotary effect by moving the modulation lever away from yourself.

01: EQUALIZER

This is a four-band stereo equalizer (low, mid x 2, high).

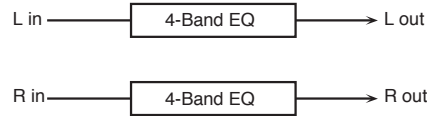

Parameter	Value	Explanation
Low Freq	200, 400[Hz]	Frequency of the low range
Low Gain #	-15--+15[dB]	Gain of the low range
Mid1 Freq	200-8000[Hz]	Frequency of the middle range 1
Mid1 Gain	-15--+15[dB]	Gain of the middle range 1
Mid1 Q	0.5, 1.0, 2.0, 4.0, 8.0	Width of the middle range 1 Set a higher value for Q to narrow the range to be affected.
Mid2 Freq	200-8000[Hz]	Frequency of the middle range 2
Mid2 Gain	-15--+15[dB]	Gain of the middle range 2
Mid2 Q	0.5, 1.0, 2.0, 4.0, 8.0	Width of the middle range 2 Set a higher value for Q to narrow the range to be affected.
High Freq	2000, 4000, 8000[Hz]	Frequency of the high range
☆ High Gain #	-15--+15[dB]	Gain of the high range
Level #	0-127	Output level

02: SPECTRUM

This is a stereo spectrum. Spectrum is a type of filter which modifies the timbre by boosting or cutting the level at specific frequencies.

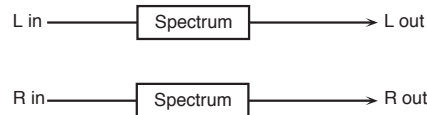

Parameter	Value	Explanation
Band1 (250[Hz])	-15--+15[dB]	Gain of each frequency band
Band2 (500[Hz])		
Band3 (1000[Hz])		
Band4 (1250[Hz])		
Band5 (2000[Hz])		
Band6 (3150[Hz])		
Band7 (4000[Hz])		
Band8 (8000[Hz])		
Q	0.5, 1.0, 2.0, 4.0, 8.0	Simultaneously adjusts the width of the adjusted ranges for all the frequency bands.
☆ Level #	0-127	Output level

03: ISOLATOR

This is an equalizer which cuts the volume greatly, allowing you to add a special effect to the sound by cutting the volume in varying ranges.

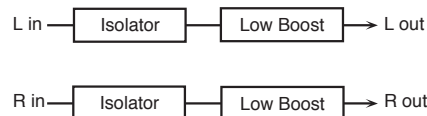

Parameter	Value	Explanation
Boost/Cut Low #	-60--+4[dB]	These boost and cut each of the High, Middle, and Low frequency ranges. At -60 dB, the sound becomes inaudible. 0 dB is equivalent to the input level of the sound.
☆ Boost/Cut Mid #		
Boost/Cut High #		
Anti Phase Low Sw	OFF, ON	Turns the Anti-Phase function on and off for the Low frequency ranges. When turned on, the counter-channel of stereo sound is inverted and added to the signal.
Anti Phase Low Level	0-127	Adjusts the level settings for the Low frequency ranges. Adjusting this level for certain frequencies allows you to lend emphasis to specific parts (This is effective only for stereo source.).
Anti Phase Mid Sw	OFF, ON	Settings of the Anti-Phase function for the Middle frequency ranges.
Anti Phase Mid Level	0-127	The parameters are the same as for the Low frequency ranges.
Low Boost Sw	OFF, ON	Turns Low Booster on/off. This emphasizes the bottom to create a heavy bass sound.
Low Boost Level	0-127	Increasing this value gives you a heavier low end. * Depending on the Isolator and filter settings this effect may be hard to distinguish.
Level	0-127	Output level

04: LOW BOOST

Boosts the volume of the lower range, creating powerful lows.



Parameter	Value	Explanation
Boost Frequency #	50-125[Hz]	Center frequency at which the lower range will be boosted
☆ Boost Gain #	0-+12[dB]	Amount by which the lower range will be boosted
Boost Width	WIDE, MID, NARROW	Width of the lower range that will be boosted
Low Gain	-15-+15[dB]	Gain of the low frequency range
High Gain	-15-+15[dB]	Gain of the high frequency range
Level	0-127	Output level

05: SUPER FILTER

This is a filter with an extremely sharp slope. The cutoff frequency can be varied cyclically.



Parameter	Value	Explanation
Filter Type	Filter type	Frequency range that will pass through each filter
	LPF	Frequencies below the cutoff
	BPF	Frequencies in the region of the cutoff
	HPF	Frequencies above the cutoff
	NOTCH	Frequencies other than the region of the cutoff
Filter Slope	Amount of attenuation per octave	
	-12[dB]	Gentle
	-24[dB]	Steep
	-36[dB]	Extremely steep
☆ Filter Cutoff #	0-127	Cutoff frequency of the filter. Increasing this value will raise the cutoff frequency.
Filter Resonance #	0-127	Filter resonance level. Increasing this value will emphasize the region near the cutoff frequency.
Filter Gain	0-+12[dB]	Amount of boost for the filter output
Modulation Sw	OFF, ON	On/off switch for cyclic change
Modulation Wave	How the cutoff frequency will be modulated	
	TRI	Triangle wave
	SQR	Square wave
	SIN	Sine wave
	SAW1	Sawtooth wave (upward)
	SAW2	Sawtooth wave (downward)
Rate #	0.05-10.00[Hz], note	Rate of modulation
Depth	0-127	Depth of modulation
Attack #	0-127	Speed at which the cutoff frequency will change. This is effective if Modulation Wave is SQR, SAW1, or SAW2.
Level	0-127	Output level

06: STEP FILTER

This is a filter whose cutoff frequency can be modulated in steps. You can specify the pattern by which the cutoff frequency will change.



Parameter	Value	Explanation
Step 01-16	0-127	Cutoff frequency at each step
☆ Rate #	0.05-10.00[Hz], note	Rate of modulation
Attack #	0-127	Speed at which the cutoff frequency changes between steps
Filter Type	Filter type	
	Frequency range that will pass through each filter	
	LPF	frequencies below the cutoff
	BPF	frequencies in the region of the cutoff
	HPF	frequencies above the cutoff
	NOTCH	frequencies other than the region of the cutoff
Filter Slope	Amount of attenuation per octave	
	-12[dB]	gentle
	-24[dB]	steep
	-36[dB]	extremely steep
Filter Resonance #	0-127	Filter resonance level. Increasing this value will emphasize the region near the cutoff frequency.
Filter Gain	0-+12[dB]	Amount of boost for the filter output
Level	0-127	Output level

MEMO

You can use MFX control to restart the step sequence from the beginning (p. 18, p. 24).

07: ENHANCER

Controls the overtone structure of the high frequencies, adding sparkle and tightness to the sound.



Parameter	Value	Explanation
Sens #	0-127	Sensitivity of the enhancer
☆ Mix #	0-127	Level of the overtones generated by the enhancer
Low Gain	-15-+15[dB]	Gain of the low range
High Gain	-15-+15[dB]	Gain of the high range
Level	0-127	Output Level

08: AUTO WAH

Cyclically controls a filter to create cyclic change in timbre.



Parameter	Value	Explanation
Filter Type	Type of filter	
	LPF	The wah effect will be applied over a wide frequency range.
	BPF	The wah effect will be applied over a narrow frequency range.
Manual #	0-127	Adjusts the center frequency at which the effect is applied.
Peak	0-127	Adjusts the amount of the wah effect that will occur in the range of the center frequency. Set a higher value for Q to narrow the range to be affected.
Sens #	0-127	Adjusts the sensitivity with which the filter is controlled.
Polarity	Sets the direction in which the frequency will change when the auto-wah filter is modulated.	
	UP	The filter will change toward a higher frequency.
	DOWN	The filter will change toward a lower frequency.
☆ Rate #	0.05-10.00[Hz], note	Frequency of modulation
Depth #	0-127	Depth of modulation
Phase #	0-180[deg]	Adjusts the degree of phase shift of the left and right sounds when the wah effect is applied.
Low Gain	-15-+15[dB]	Gain of the low range
High Gain	-15-+15[dB]	Gain of the high range
Level	0-127	Output level

09: HUMANIZER

Adds a vowel character to the sound, making it similar to a human voice.

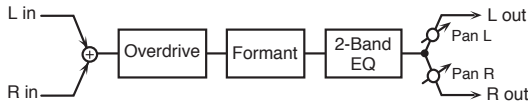

Parameter	Value	Explanation
Drive Sw	OFF, ON	Turns Drive on/off.
Drive #	0-127	Degree of distortion Also changes the volume.
Vowel1	a, e, i, o, u	Selects the vowel.
Vowel2	a, e, i, o, u	
☆ Rate #	0.05-10.00[Hz], note	Frequency at which the two vowels switch
Depth #	0-127	Effect depth
Input Sync Sw	OFF, ON	LFO reset on/off Determines whether the LFO for switching the vowels is reset by the input signal (ON) or not (OFF).
Input Sync Threshold	0-127	Volume level at which reset is applied
Manual #	Point at which Vowel 1/2 switch	
	49 or less	Vowel 1 will have a longer duration.
	50	Vowel 1 and 2 will be of equal duration.
	51 or more	Vowel 2 will have a longer duration.
Low Gain	-15-+15[dB]	Gain of the low frequency range
High Gain	-15-+15[dB]	Gain of the high frequency range
Pan #	L64-63R	Stereo location of the output
Level	0-127	Output level

10: SPEAKER SIMULATOR

Simulates the speaker type and microphone settings used to record the speaker sound.

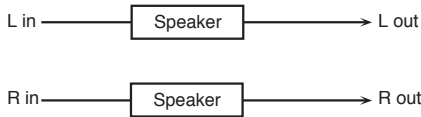

Parameter	Value	Explanation
Speaker Type	(See the following table)	Type of speaker
Mic Setting	1, 2, 3	Adjusts the location of the microphone that is recording the sound of the speaker. This can be adjusted in three steps, with the microphone becoming more distant in the order of 1, 2, and 3.
☆ Mic Level #	0-127	Volume of the microphone
Direct Level #	0-127	Volume of the direct sound
Level #	0-127	Output level

Specifications of each Speaker Type

The speaker column indicates the diameter of each speaker unit (in inches) and the number of units.

Type	Cabinet	Speaker	Microphone
SMALL 1	small open-back enclosure	10	dynamic
SMALL 2	small open-back enclosure	10	dynamic
MIDDLE	open back enclosure	12 x 1	dynamic
JC-120	open back enclosure	12 x 2	dynamic
BUILT-IN 1	open back enclosure	12 x 2	dynamic
BUILT-IN 2	open back enclosure	12 x 2	condenser
BUILT-IN 3	open back enclosure	12 x 2	condenser
BUILT-IN 4	open back enclosure	12 x 2	condenser
BUILT-IN 5	open back enclosure	12 x 2	condenser
BG STACK 1	sealed enclosure	12 x 2	condenser
BG STACK 2	large sealed enclosure	12 x 2	condenser
MS STACK 1	large sealed enclosure	12 x 4	condenser
MS STACK 2	large sealed enclosure	12 x 4	condenser
METAL STACK	large double stack	12 x 4	condenser
2-STACK	large double stack	12 x 4	condenser
3-STACK	large triple stack	12 x 4	condenser

11: PHASER

This is a stereo phaser. A phase-shifted sound is added to the original sound and modulated.

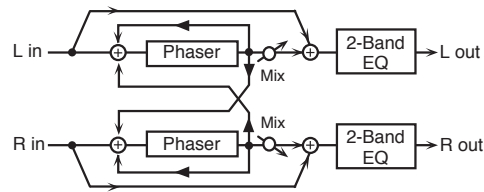

Parameter	Value	Explanation
Mode	4-STAGE, 8-STAGE, 12-STAGE	Number of stages in the phaser
☆ Manual #	0-127	Adjusts the basic frequency from which the sound will be modulated.
Rate	0.05-10.00[Hz], note	Frequency of modulation
Depth	0-127	Depth of modulation
Polarity	Selects whether the left and right phase of the modulation will be the same or the opposite.	
	INVERSE	The left and right phase will be opposite. When using a mono source, this spreads the sound.
	SYNCHRO	The left and right phase will be the same. Select this when inputting a stereo source.
Resonance #	0-127	Amount of feedback
Cross Feedback	-98-+98[%]	Adjusts the proportion of the phaser sound that is fed back into the effect. Negative (-) settings will invert the phase.
Mix #	0-127	Level of the phase-shifted sound
Low Gain	-15-+15[dB]	Gain of the low range
High Gain	-15-+15[dB]	Gain of the high range
Level	0-127	Output level

12: STEP PHASER

This is a stereo phaser. The phaser effect will be varied gradually.

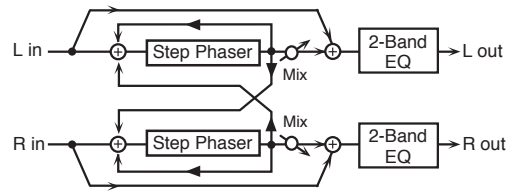

Parameter	Value	Explanation
Mode	4-STAGE, 8-STAGE, 12-STAGE	Number of stages in the phaser
☆ Manual #	0-127	Adjusts the basic frequency from which the sound will be modulated.
Rate #	0.05-10.00[Hz], note	Frequency of modulation
Depth	0-127	Depth of modulation
Polarity	Selects whether the left and right phase of the modulation will be the same or the opposite.	
	INVERSE	The left and right phase will be opposite. When using a mono source, this spreads the sound.
	SYNCHRO	The left and right phase will be the same. Select this when inputting a stereo source.
Resonance #	0-127	Amount of feedback
Cross Feedback	-98-+98[%]	Adjusts the proportion of the phaser sound that is fed back into the effect. Negative (-) settings will invert the phase.
Step Rate #	0.10-20.00[Hz], note	Rate of the step-wise change in the phaser effect
Mix #	0-127	Level of the phase-shifted sound
Low Gain	-15-+15[dB]	Gain of the low range
High Gain	-15-+15[dB]	Gain of the high range
Level	0-127	Output level

13: MLT STAGE PHASER

Extremely high settings of the phase difference produce a deep phaser effect.

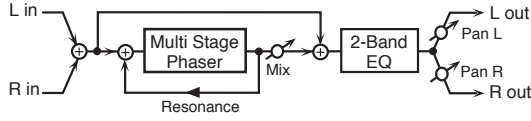

Parameter	Value	Explanation
Mode	4-STAGE, 8-STAGE, 12-STAGE, 16-STAGE, 20-STAGE, 24-STAGE	Number of phaser stages
☆ Manual #	0-127	Adjusts the basic frequency from which the sound will be modulated.
Rate #	0.05-10.00[Hz], note	Frequency of modulation
Depth	0-127	Depth of modulation
Resonance #	0-127	Amount of feedback
Mix #	0-127	Level of the phase-shifted sound
Pan #	L64-63R	Stereo location of the output sound
Low Gain	-15-+15[dB]	Gain of the low range
High Gain	-15-+15[dB]	Gain of the high range
Level	0-127	Output level

14: INFINITE PHASER

A phaser that continues raising/lowering the frequency at which the sound is modulated.

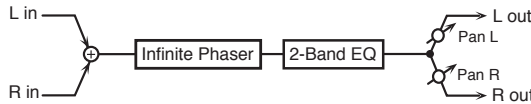

Parameter	Value	Explanation
Mode	1-4	Higher values will produce a deeper phaser effect.
☆ Speed #	-100-+100	Speed at which to raise or lower the frequency at which the sound is modulated (+: upward / -: downward)
Resonance #	0-127	Amount of feedback
Mix #	0-127	Volume of the phase-shifted sound
Pan #	L64-63R	Panning of the output sound
Low Gain	-15-+15[dB]	Amount of boost/cut for the low-frequency range
High Gain	-15-+15[dB]	Amount of boost/cut for the high-frequency range
Level	0-127	Output level

15: RING MODULATOR

This is an effect that applies amplitude modulation (AM) to the input signal, producing bell-like sounds. You can also change the modulation frequency in response to changes in the volume of the sound sent into the effect.



Parameter	Value	Explanation
☆ Frequency #	0-127	Adjusts the frequency at which modulation is applied.
Sens #	0-127	Adjusts the amount of frequency modulation applied.
Polarity	Determines whether the frequency modulation moves towards higher frequencies or lower frequencies.	
	UP	Higher frequencies
	DOWN	Lower frequencies
Low Gain	-15-+15[dB]	Gain of the low frequency range
High Gain	-15-+15[dB]	Gain of the high frequency range
Balance #	D100:0W-D0:100W	Volume balance between the direct sound (D) and the effect sound (W)
Level	0-127	Output level

16: STEP RING MOD

This is a ring modulator that uses a 16-step sequence to vary the frequency at which modulation is applied.



Parameter	Value	Explanation
Step 01-16	0-127	Frequency of ring modulation at each step
☆ Rate #	0.05-10.00[Hz], note	Rate at which the 16-step sequence will cycle
Attack #	0-127	Speed at which the modulation frequency changes between steps
Low Gain	-15-+15[dB]	Amount of boost/cut for the low-frequency range
High Gain	-15-+15[dB]	Amount of boost/cut for the high-frequency range
Balance #	D100:0W-D0:100W	Volume balance of the original sound (D) and effect sound (W)
Level	0-127	Output level

MEMO

You can use MFX control to restart the step sequence from the beginning (p. 18, p. 24).

17: TREMOLO

Cyclically modulates the volume to add tremolo effect to the sound.



Parameter	Value	Explanation
Mod Wave	Modulation Wave	
	TRI	Triangle wave
	SQR	Square wave
	SIN	Sine wave
	SAW1, 2	Sawtooth wave
☆ Rate #	0.05-10.00[Hz], note	Frequency of the change
Depth #	0-127	Depth to which the effect is applied
Low Gain	-15-+15[dB]	Gain of the low range
High Gain	-15-+15[dB]	Gain of the high range
Level	0-127	Output level

18: AUTO PAN

Cyclically modulates the stereo location of the sound.



Parameter	Value	Explanation
Mod Wave	Modulation Wave	
	TRI	Triangle wave
	SQR	Square wave
	SIN	Sine wave
	SAW1, 2	Sawtooth wave
☆ Rate #	0.05-10.00[Hz], note	Frequency of the change
Depth #	0-127	Depth to which the effect is applied
Low Gain	-15-+15[dB]	Gain of the low range
High Gain	-15-+15[dB]	Gain of the high range
Level	0-127	Output level

19: STEP PAN

This uses a 16-step sequence to vary the panning of the sound.

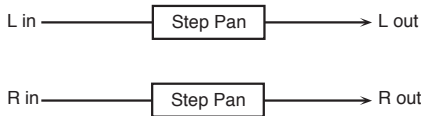

Parameter	Value	Explanation
Step 01-16	L64-63R	Pan at each step
☆ Rate #	0.05-10.00[Hz], note	Rate at which the 16-step sequence will cycle
Attack #	0-127	Speed at which the pan changes between steps
Input Sync Sw	OFF, ON	Specifies whether an input note will cause the sequence to resume from the first step of the sequence (ON) or not (OFF)
Input Sync Threshold	0-127	Volume at which an input note will be detected
Level	0-127	Output level

MEMO

You can use MFX control to restart the step sequence from the beginning (p. 18, p. 24).

20: SLICER

By applying successive cuts to the sound, this effect turns a conventional sound into a sound that appears to be played as a backing phrase. This is especially effective when applied to sustain-type sounds.

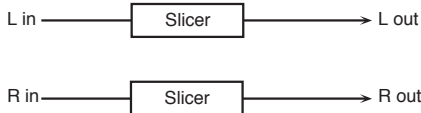

Parameter	Value	Explanation
Step 01-16	0-127	Level at each step
☆ Rate #	0.05-10.00[Hz], note	Rate at which the 16-step sequence will cycle
Attack #	0-127	Speed at which the level changes between steps
Input Sync Sw	OFF, ON	Specifies whether an input note will cause the sequence to resume from the first step of the sequence (ON) or not (OFF)
Input Sync Threshold	0-127	Volume at which an input note will be detected
Mode	LEGATO	Sets the manner in which the volume changes as one step progresses to the next. The change in volume from one step's level to the next remains unaltered. If the level of a following step is the same as the one preceding it, there is no change in volume.
	SLASH	The level is momentarily set to 0 before progressing to the level of the next step. This change in volume occurs even if the level of the following step is the same as the preceding step.
Shuffle #	0-127	Timing of volume changes in levels for even-numbered steps (step 2, step 4, step 6...). The higher the value, the later the beat progresses.
Level	0-127	Output level

MEMO

You can use MFX control to restart the step sequence from the beginning (p. 18, p. 24).

21: ROTARY

The Rotary effect simulates the sound of the rotary speakers often used with the electric organs of the past. Since the movement of the high range and low range rotors can be set independently, the unique type of modulation characteristic of these speakers can be simulated quite closely. This effect is most suitable for electric organ Tones.

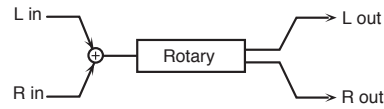

Parameter	Value	Explanation
☆ Speed #	Simultaneously switch the rotational speed of the low frequency rotor and high frequency rotor. SLOW FAST	Slows down the rotation to the Slow Rate. Speeds up the rotation to the Fast Rate.
Woofer Slow Speed	0.05-10.00[Hz]	Slow speed (SLOW) of the low frequency rotor
Woofer Fast Speed	0.05-10.00[Hz]	Fast speed (FAST) of the low frequency rotor
Woofer Acceleration	0-15	Adjusts the time it takes the low frequency rotor to reach the newly selected speed when switching from fast to slow (or slow to fast) speed.
Woofer Level	0-127	Volume of the low frequency rotor
Tweeter Slow Speed	0.05-10.00[Hz]	Settings of the high frequency rotor The parameters are the same as for the low frequency rotor.
Tweeter Fast Speed	0.05-10.00[Hz]	
Tweeter Acceleration	0-15	
Tweeter Level	0-127	
Separation	0-127	Spatial dispersion of the sound
Level #	0-127	Output level

22: VK ROTARY

This type provides modified response for the rotary speaker, with the low end boosted further. This effect features the same specifications as the VK-7's built-in rotary speaker.

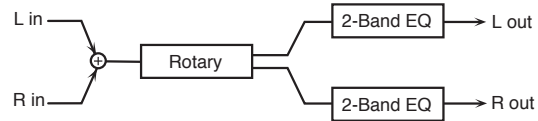

Parameter	Value	Explanation
☆ Speed #	Rotational speed of the rotating speaker SLOW FAST	Slow Fast
☆ Brake #	OFF, ON	Switches the rotation of the rotary speaker. When this is turned on, the rotation will gradually stop. When it is turned off, the rotation will gradually resume.
Woofer Slow Speed	0.05-10.00[Hz]	Low-speed rotation speed of the woofer
Woofer Fast Speed	0.05-10.00[Hz]	High-speed rotation speed of the woofer
Woofer Trans Up	0-127	Adjusts the rate at which the woofer rotation speeds up when the rotation is switched from SLOW to FAST.
Woofer Trans Down	0-127	Adjusts the rate at which the woofer rotation speeds up when the rotation is switched from FAST to SLOW.
Woofer Level	0-127	Volume of the woofer
Tweeter Slow Speed	0.05-10.00[Hz]	Settings of the tweeter The parameters are the same as for the woofer.
Tweeter Fast Speed	0.05-10.00[Hz]	
Tweeter Trans Up	0-127	
Tweeter Trans Down	0-127	
Tweeter Level	0-127	
Spread	0-10	Sets the rotary speaker stereo image.
Low Gain	-15-+15[dB]	Gain of the low range
High Gain	-15-+15[dB]	Gain of the high range
Level #	0-127	Output level
Type	STANDARD, STACK, CLEAN	Type of speaker

23: CHORUS

This is a stereo chorus. A filter is provided so that you can adjust the timbre of the chorus sound.

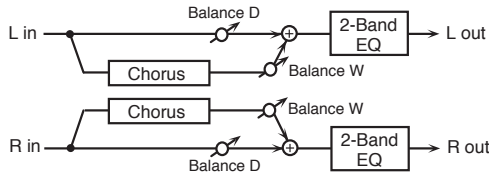

Parameter	Value	Explanation
Filter Type	Type of filter	
	OFF	No filter is used
	LPF	Cuts the frequency range above the Cutoff Freq
Cutoff Freq	HPF	Cuts the frequency range below the Cutoff Freq
	200–8000[Hz]	Center frequency when using the filter to cut a specific frequency range
Pre Delay	0.0–100[msec]	Adjusts the delay time from the direct sound until the chorus sound is heard.
☆ Rate #	0.05–10.00[Hz], note	Frequency of modulation
Depth	0–127	Depth of modulation
Phase	0–180[deg]	Spatial spread of the sound
Low Gain	-15–+15[dB]	Gain of the low range
High Gain	-15–+15[dB]	Gain of the high range
Balance #	D100:0W–D0:100W	Volume balance between the direct sound (D) and the chorus sound (W)
Level	0–127	Output level

24: FLANGER

This is a stereo flanger (The LFO has the same phase for left and right.). It produces a metallic resonance that rises and falls like a jet airplane taking off or landing. A filter is provided so that you can adjust the timbre of the flanged sound.

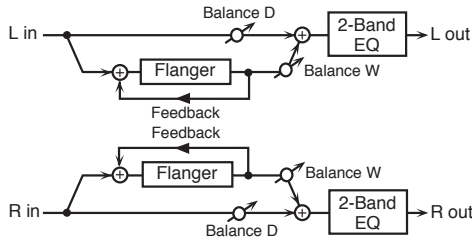

Parameter	Value	Explanation
Filter Type	Type of filter	
	OFF	No filter is used
	LPF	Cuts the frequency range above the Cutoff Freq
Cutoff Freq	HPF	Cuts the frequency range below the Cutoff Freq
	200–8000[Hz]	Center frequency when using the filter to cut a specific frequency range
Pre Delay	0.0–100[msec]	Adjusts the delay time from when the direct sound begins until the flanger sound is heard.
☆ Rate #	0.05–10.00[Hz], note	Frequency of modulation
Depth	0–127	Depth of modulation
Phase	0–180[deg]	Spatial spread of the sound
Feedback #	-98–+98[%]	Adjusts the proportion of the flanger sound that is fed back into the effect. Negative (-) settings will invert the phase.
Low Gain	-15–+15[dB]	Gain of the low range
High Gain	-15–+15[dB]	Gain of the high range
Balance #	D100:0W–D0:100W	Volume balance between the direct sound (D) and the flanger sound (W)
Level	0–127	Output level

25: STEP FLANGER

This is a flanger in which the flanger pitch changes in steps. The speed at which the pitch changes can also be specified in terms of a note-value of a specified tempo.

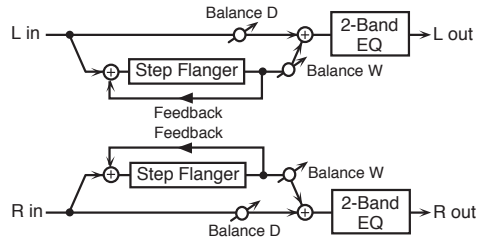

Parameter	Value	Explanation
Filter Type	Type of filter	
	OFF	No filter is used
	LPF	Cuts the frequency range above the Cutoff Freq
Cutoff Freq	HPF	Cuts the frequency range below the Cutoff Freq
	200–8000[Hz]	Center frequency when using the filter to cut a specific frequency range
Pre Delay	0.0–100[msec]	Adjusts the delay time from when the direct sound begins until the flanger sound is heard.
☆ Rate #	0.05–10.00[Hz], note	Frequency of modulation
Depth	0–127	Depth of modulation
Phase	0–180[deg]	Spatial spread of the sound
Feedback #	-98–+98[%]	Adjusts the proportion of the flanger sound that is fed back into the effect. Negative (-) settings will invert the phase.
☆ Step Rate #	0.10–20.00[Hz], note	Rate (period) of pitch change
Low Gain	-15–+15[dB]	Gain of the low range
High Gain	-15–+15[dB]	Gain of the high range
Balance #	D100:0W–D0:100W	Volume balance between the direct sound (D) and the flanger sound (W)
Level	0–127	Output level

26: HEXA-CHORUS

Uses a six-phase chorus (six layers of chorused sound) to give richness and spatial spread to the sound.

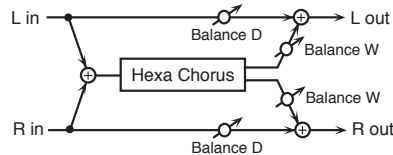

Parameter	Value	Explanation
Pre Delay	0.0–100[msec]	Adjusts the delay time from the direct sound until the chorus sound is heard.
☆ Rate #	0.05–10.00[Hz], note	Frequency of modulation
Depth	0–127	Depth of modulation
Pre Delay Deviation	0–20	Adjusts the differences in Pre Delay between each chorus sound.
Depth Deviation	-20–+20	Adjusts the difference in modulation depth between each chorus sound.
Pan Deviation	0–20	Adjusts the difference in stereo location between each chorus sound.
	0	All chorus sounds will be in the center.
	20	Each chorus sound will be spaced at 60 degree intervals relative to the center.
Balance #	D100:0W–D0:100W	Volume balance between the direct sound (D) and the chorus sound (W)
Level	0–127	Output level

27: TREMOLO CHORUS

This is a chorus effect with added Tremolo (cyclic modulation of volume).

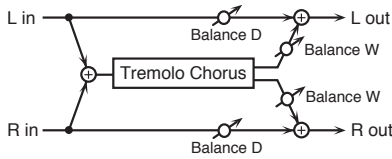

Parameter	Value	Explanation
Pre Delay	0.0–100[msec]	Adjusts the delay time from the direct sound until the chorus sound is heard.
☆ Chorus Rate #	0.05–10.00[Hz], note	Modulation frequency of the chorus effect
Chorus Depth	0–127	Modulation depth of the chorus effect
Tremolo Rate #	0.05–10.00[Hz], note	Modulation frequency of the tremolo effect
Tremolo Separation	0–127	Spread of the tremolo effect
Tremolo Phase	0–180[deg]	Spread of the tremolo effect
Balance #	D100:0W–D0:100W	Volume balance between the direct sound (D) and the tremolo chorus sound (W)
Level	0–127	Output level

28: SPACE-D

This is a multiple chorus that applies two-phase modulation in stereo. It gives no impression of modulation, but produces a transparent chorus effect.

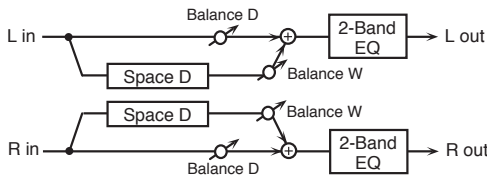

Parameter	Value	Explanation
Pre Delay	0.0–100[msec]	Adjusts the delay time from the direct sound until the chorus sound is heard.
☆ Rate #	0.05–10.00[Hz], note	Frequency of modulation
Depth	0–127	Depth of modulation
Phase	0–180[deg]	Spatial spread of the sound
Low Gain	-15–+15[dB]	Gain of the low range
High Gain	-15–+15[dB]	Gain of the high range
Balance #	D100:0W–D0:100W	Volume balance between the direct sound (D) and the chorus sound (W)
Level	0–127	Output level

29: 3D CHORUS

This applies a 3D effect to the chorus sound. The chorus sound will be positioned 90 degrees left and 90 degrees right.

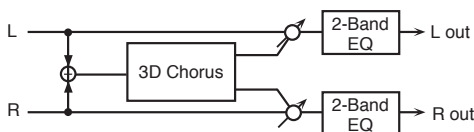

Parameter	Value	Explanation
Filter Type	Type of filter	
	OFF	No filter is used
	LPF	Cuts the frequency range above the Cutoff Freq
	HPF	Cuts the frequency range below the Cutoff Freq
Cutoff Freq	200–8000[Hz]	Center frequency when using the filter to cut a specific frequency range
Pre Delay	0.0–100[msec]	Adjusts the delay time from the direct sound until the chorus sound is heard.
☆ Rate #	0.05–10.00[Hz], note	Frequency of modulation
Depth	0–127	Modulation depth of the chorus effect
Phase	0–180[deg]	Spatial spread of the sound
Output Mode	The optimal 3D effect will be achieved.	
	SPEAKER	When using speakers
	PHONES	When using headphones
Low Gain	-15–+15[dB]	Gain of the low range
High Gain	-15–+15[dB]	Gain of the high range
Balance #	D100:0W–D0:100W	Volume balance between the direct sound (D) and the chorus sound (W)
Level	0–127	Output level

30: 3D FLANGER

This applies a 3D effect to the flanger sound. The flanger sound will be positioned 90 degrees left and 90 degrees right.

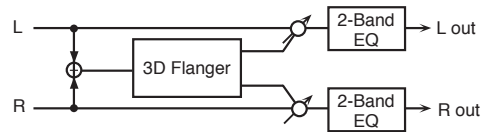

Parameter	Value	Explanation
Filter Type	Type of filter	
	OFF	No filter is used
	LPF	Cuts the frequency range above the Cutoff Freq
	HPF	Cuts the frequency range below the Cutoff Freq
Cutoff Freq	200–8000[Hz]	Center frequency when using the filter to cut a specific frequency range
Pre Delay	0.0–100[msec]	Adjusts the delay time from when the direct sound begins until the flanger sound is heard.
☆ Rate #	0.05–10.00[Hz], note	Frequency of modulation
Depth	0–127	Depth of modulation
Phase	0–180[deg]	Spatial spread of the sound
Feedback #	-98–+98[%]	Adjusts the proportion of the flanger sound that is fed back into the effect. Negative (-) settings will invert the phase.
Output Mode	The optimal 3D effect will be achieved.	
	SPEAKER	When using speakers
	PHONES	When using headphones
Low Gain	-15–+15[dB]	Gain of the low range
High Gain	-15–+15[dB]	Gain of the high range
Balance #	D100:0W–D0:100W	Volume balance between the direct sound (D) and the flanger sound (W)
Level	0–127	Output level

31: 3D STEP FLANGER

This applies a 3D effect to the step flanger sound. The flanger sound will be positioned 90 degrees left and 90 degrees right.

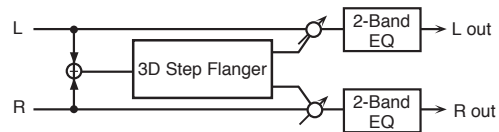

Parameter	Value	Explanation
Filter Type	Type of filter	
	OFF	No filter is used
	LPF	Cuts the frequency range above the Cutoff Freq
	HPF	Cuts the frequency range below the Cutoff Freq
Cutoff Freq	200–8000[Hz]	Center frequency when using the filter to cut a specific frequency range
Pre Delay	0.0–100[msec]	Adjusts the delay time from when the direct sound begins until the flanger sound is heard.
Rate #	0.05–10.00[Hz], note	Frequency of modulation
Depth	0–127	Depth of modulation
Phase	0–180[deg]	Spatial spread of the sound
Feedback #	-98–+98[%]	Adjusts the proportion of the flanger sound that is fed back into the effect. Negative (-) settings will invert the phase.
☆ Step Rate #	0.10–20.00[Hz], note	Rate (period) of pitch change
Output Mode	The optimal 3D effect will be achieved.	
	SPEAKER	When using speakers
	PHONES	When using headphones
Low Gain	-15–+15[dB]	Gain of the low range
High Gain	-15–+15[dB]	Gain of the high range
Balance #	D100:0W–D0:100W	Volume balance between the direct sound (D) and the flanger sound (W)
Level	0–127	Output level

32: 2BAND CHORUS

A chorus effect that lets you apply an effect independently to the low-frequency and high-frequency ranges.

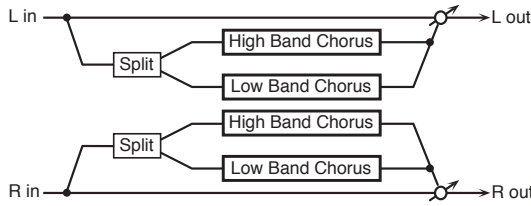

Parameter	Value	Explanation
Split Freq	200–8000[Hz]	Frequency at which the low and high ranges will be divided
Low Pre Delay	0.0–100[msec]	Delay time from when the original sound is heard to when the low-range chorus sound is heard
Low Rate #	0.05–10.00[Hz], note	Rate at which the low-range chorus sound is modulated
Low Depth	0–127	Modulation depth for the low-range chorus sound
Low Phase	0–180[deg]	Spaciousness of the low-range chorus sound
High Pre Delay	0.0–100[msec]	Delay time from when the original sound is heard to when the high-range chorus sound is heard
☆ High Rate #	0.05–10.00[Hz], note	Rate at which the high-range chorus sound is modulated
High Depth	0–127	Modulation depth for the high-range chorus sound
High Phase	0–180[deg]	Spaciousness of the high-range chorus sound
Balance #	D100:0W–D0:100W	Volume balance of the original sound (D) and chorus sound (W)
Level	0–127	Output level

33: 2BAND FLANGER

A flanger that lets you apply an effect independently to the low-frequency and high-frequency ranges.

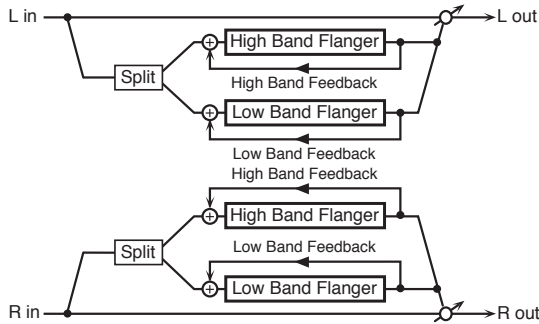

Parameter	Value	Explanation
Split Freq	200–8000[Hz]	Frequency at which the low and high ranges will be divided
Low Pre Delay	0.0–100[msec]	Delay time from when the original sound is heard to when the low-range flanger sound is heard
Low Rate #	0.05–10.00[Hz], note	Rate at which the low-range flanger sound is modulated
Low Depth	0–127	Modulation depth for the low-range flanger sound
Low Phase	0–180[deg]	Spaciousness of the low-range flanger sound
Low Feedback #	-98–+98[%]	Proportion of the low-range flanger sound that is to be returned to the input (negative (-) values invert the phase)
High Pre Delay	0.0–100[msec]	Delay time from when the original sound is heard to when the high-range flanger sound is heard
☆ High Rate #	0.05–10.00[Hz], note	Rate at which the high-range flanger sound is modulated
High Depth	0–127	Modulation depth for the high-range flanger sound
High Phase	0–180[deg]	Spaciousness of the high-range flanger sound
High Feedback #	-98–+98[%]	Proportion of the high-range flanger sound that is to be returned to the input (negative (-) values invert the phase)
Balance #	D100:0W–D0:100W	Volume balance of the original sound (D) and flanger sound (W)
Level	0–127	Output level

34: 2BAND STEP FLNGER

A step flanger that lets you apply an effect independently to the low-frequency and high-frequency ranges.

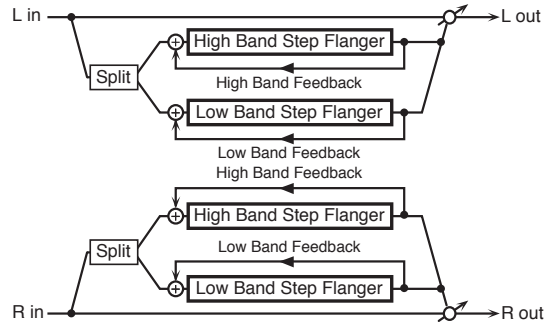

Parameter	Value	Explanation
Split Freq	200–8000[Hz]	Frequency at which the low and high ranges will be divided
Low Pre Delay	0.0–100[msec]	Delay time from when the original sound is heard to when the low-range flanger sound is heard
Low Rate #	0.05–10.00[Hz], note	Rate at which the low-range flanger sound is modulated
Low Depth	0–127	Modulation depth for the low-range flanger sound
Low Phase	0–180[deg]	Spaciousness of the low-range flanger sound
Low Feedback #	-98–+98[%]	Proportion of the low-range flanger sound that is to be returned to the input (negative (-) values invert the phase)
Low Step Rate #	0.10–20.00[Hz], note	Rate at which the steps will cycle for the low-range flanger sound
High Pre Delay	0.0–100[msec]	Delay time from when the original sound is heard to when the high-range flanger sound is heard
High Rate #	0.05–10.00[Hz], note	Rate at which the high-range flanger sound is modulated
High Depth	0–127	Modulation depth for the high-range flanger sound
High Phase	0–180[deg]	Spaciousness of the high-range flanger sound
High Feedback #	-98–+98[%]	Proportion of the high-range flanger sound that is to be returned to the input (negative (-) values invert the phase)
☆ High Step Rate #	0.10–20.00[Hz], note	Rate at which the steps will cycle for the high-range flanger sound
Balance #	D100:0W–D0:100W	Volume balance of the original sound (D) and flanger sound (W)
Level	0–127	Output level

35: OVERDRIVE

Creates a soft distortion similar to that produced by vacuum tube amplifiers.

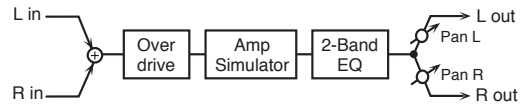

Parameter	Value	Explanation
☆ Drive #	0–127	Degree of distortion Also changes the volume.
Amp Type	Type of guitar amp	
	SMALL	Small amp
	BUILT-IN	Single-unit type amp
	2-STACK	Large double stack amp
Low Gain	3-STACK	Large triple stack amp
	-15–+15[dB]	Gain of the low range
High Gain	-15–+15[dB]	Gain of the high range
Pan #	L64–63R	Stereo location of the output sound
Level	0–127	Output level

36: DISTORTION

Produces a more intense distortion than Overdrive. The parameters are the same as for “35: OVERDRIVE.”

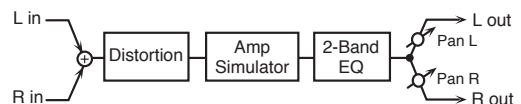

37: VS OVERDRIVE

This is an overdrive that provides heavy distortion.

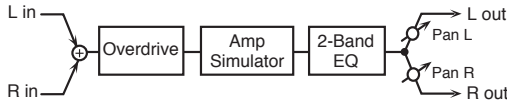

Parameter	Value	Explanation
☆ Drive #	0–127	Degree of distortion Also changes the volume.
Tone #	0–127	Sound quality of the Overdrive effect
Amp Sw	OFF, ON	Turns the Amp Simulator on/off.
Amp Type	Type of guitar amp	
	SMALL	Small amp
	BUILT-IN	Single-unit type amp
	2-STACK 3-STACK	Large double stack amp Large triple stack amp
Low Gain	-15→+15[dB]	Gain of the low range
High Gain	-15→+15[dB]	Gain of the high range
Pan #	L64–63R	Stereo location of the output sound
Level	0–127	Output level

38: VS DISTORTION

This is a distortion effect that provides heavy distortion. The parameters are the same as for “37: VS OVERDRIVE.”

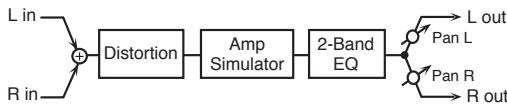

39: GUITAR AMP SIM

This is an effect that simulates the sound of a guitar amplifier.

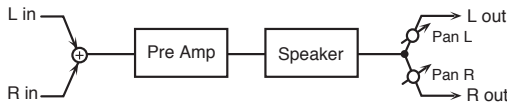

Parameter	Value	Explanation	
Pre Amp Sw	OFF, ON	Turns the amp switch on/off.	
Pre Amp Type	Type of guitar amp		
	JC-120, CLEAN TWIN, MATCH DRIVE, BG LEAD, MS1959I, MS1959II, MS1959I+II, SLDN LEAD, METAL 5150, METAL LEAD, OD-1, OD-2 TURBO, DISTORTION, FUZZ		
	☆ Pre Amp Volume #	0–127	Volume and amount of distortion of the amp
	Pre Amp Master #	0–127	Volume of the entire pre-amp
	Pre Amp Gain	LOW, MIDDLE, HIGH	Amount of pre-amp distortion
	Pre Amp Bass	0–127	Tone of the bass/mid/treble frequency range Middle cannot be set if “MATCH DRIVE” is selected as the Pre Amp Type.
	Pre Amp Middle		
	Pre Amp Treble		
	Pre Amp Presence	0–127	Tone for the ultra-high frequency range
	Pre Amp Bright	OFF, ON	Turning this “On” produces a sharper and brighter sound. This parameter applies to the “JC-120,” “CLEAN TWIN,” and “BG LEAD” Pre Amp Types.
Speaker Sw	OFF, ON	Determines whether the signal passes through the speaker (ON), or not (OFF).	
Speaker Type	(See the following table)	Type of speaker	
Mic Setting	1–3	Adjusts the location of the microphone that’s capturing the sound of the speaker. This can be adjusted in three steps, from 1 to 3, with the microphone becoming more distant as the value increases.	
Mic Level	0–127	Volume of the microphone	
Direct Level	0–127	Volume of the direct sound	
Pan #	L64–63R	Stereo location of the output sound	
Level #	0–127	Output level	

Specifications of each Speaker Type

The speaker column indicates the diameter of each speaker unit (in inches) and the number of units.

Type	Cabinet	Speaker	Microphone
SMALL 1	small open-back enclosure	10	dynamic
SMALL 2	small open-back enclosure	10	dynamic
MIDDLE	open back enclosure	12 x 1	dynamic
JC-120	open back enclosure	12 x 2	dynamic
BUILT-IN 1	open back enclosure	12 x 2	dynamic
BUILT-IN 2	open back enclosure	12 x 2	condenser
BUILT-IN 3	open back enclosure	12 x 2	condenser
BUILT-IN 4	open back enclosure	12 x 2	condenser
BUILT-IN 5	open back enclosure	12 x 2	condenser
BG STACK 1	sealed enclosure	12 x 2	condenser
BG STACK 2	large sealed enclosure	12 x 2	condenser
MS STACK 1	large sealed enclosure	12 x 4	condenser
MS STACK 2	large sealed enclosure	12 x 4	condenser
METAL STACK	large double stack	12 x 4	condenser
2-STACK	large double stack	12 x 4	condenser
3-STACK	large triple stack	12 x 4	condenser

40: COMPRESSOR

Flattens out high levels and boosts low levels, smoothing out fluctuations in volume.

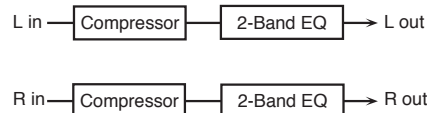

Parameter	Value	Explanation
Attack #	0–127	Sets the time from when the input exceeds the Threshold until the volume starts being compressed
☆ Threshold #	0–127	Adjusts the volume at which compression begins
Post Gain	0→+18[dB]	Adjusts the output gain.
Low Gain	-15→+15[dB]	Gain of the low range
High Gain	-15→+15[dB]	Gain of the high range
Level #	0–127	Output level

41: LIMITER

Compresses signals that exceed a specified volume level, preventing distortion from occurring.

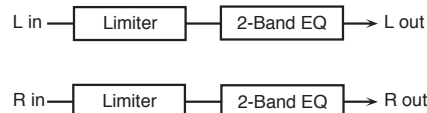

Parameter	Value	Explanation
Release #	0–127	Adjusts the time after the signal volume falls below the Threshold Level until compression is no longer applied.
☆ Threshold #	0–127	Adjusts the volume at which compression begins
Ratio	1.5:1, 2:1, 4:1, 100:1	Compression ratio
Post Gain	0→+18[dB]	Adjusts the output gain.
Low Gain	-15→+15[dB]	Gain of the low range
High Gain	-15→+15[dB]	Gain of the high range
Level #	0–127	Output level

42: GATE

Cuts the reverb's delay according to the volume of the sound sent into the effect. Use this when you want to create an artificial-sounding decrease in the reverb's decay.

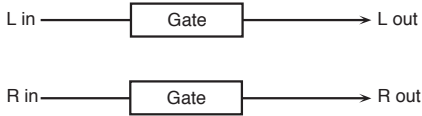

Parameter	Value	Explanation
☆ Threshold #	0–127	Volume level at which the gate begins to close
Mode	Type of gate	
	GATE	The gate will close when the volume of the original sound decreases, cutting the original sound.
	DUCK (Duking)	The gate will close when the volume of the original sound increases, cutting the original sound.
Attack	0–127	Adjusts the time it takes for the gate to fully open after being triggered.
Hold	0–127	Adjusts the time it takes for the gate to start closing after the source sound falls beneath the Threshold.
Release	0–127	Adjusts the time it takes the gate to fully close after the hold time.
Balance #	D100:0W–D0:100W	Volume balance between the direct sound (D) and the effect sound (W)
Level	0–127	Output level

44: LONG DELAY

A delay that provides a long delay time.

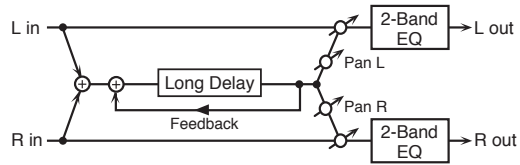

Parameter	Value	Explanation
☆ Delay Time	0–2600[msec], note	Delay time from when the original sound is heard to when the delay sound is heard
Phase	NORMAL, INVERSE	Phase of the delay (NORMAL: non-inverted, INVERT: inverted)
Feedback #	-98–+98[%]	Proportion of the delay sound that is to be returned to the input (negative (-) values invert the phase)
HF Damp	200–8000[Hz], BYPASS	Frequency at which the high-frequency content of the delayed sound will be cut (BYPASS: no cut)
Pan #	L64–63R	Panning of the delay sound
Low Gain	-15–+15[dB]	Gain of the low range
High Gain	-15–+15[dB]	Gain of the high range
Balance #	D100:0W–D0:100W	Volume balance of the original sound (D) and delay sound (W)
Level	0–127	Output level

43: DELAY

This is a stereo delay.

When Feedback Mode is NORMAL:

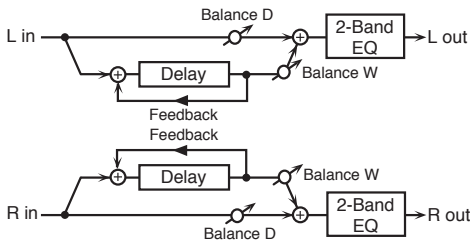

When Feedback Mode is CROSS:

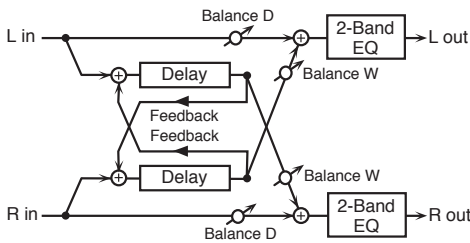

Parameter	Value	Explanation
Delay Left	0–1300[msec], note	Adjusts the time until the delay sound is heard.
Delay Right		
Phase Left	Phase of the left delay sound	
	NORMAL	Non-inverted
	INVERT	Inverted
Phase Right	Phase of the right delay sound	
	NORMAL	Non-inverted
	INVERT	Inverted
Feedback Mode	NORMAL, CROSS	Selects the way in which delay sound is fed back into the effect (See the figures.).
☆ Feedback #	-98–+98[%]	Adjusts the amount of the delay sound that's fed back into the effect. Negative (-) settings invert the phase.
HF Damp	200–8000[Hz], BYPASS	Adjusts the frequency above which sound fed back to the effect is filtered out. If you don't want to filter out any high frequencies, set this parameter to BYPASS.
Low Gain	-15–+15[dB]	Gain of the low range
High Gain	-15–+15[dB]	Gain of the high range
Balance #	D100:0W–D0:100W	Volume balance between the direct sound (D) and the delay sound (W)
Level	0–127	Output level

45: SERIAL DELAY

This delay connects two delay units in series. Feedback can be applied independently to each delay unit, allowing you to produce complex delay sounds.

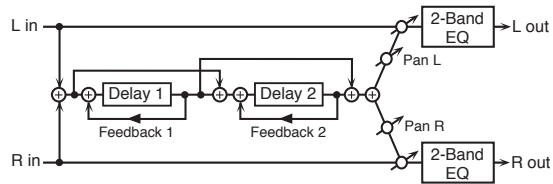

Parameter	Value	Explanation
Delay 1 Time	0–1300[msec], note	Delay time from when sound is input to delay 1 until the delay sound is heard
☆ Delay 1 Feedback #	-98–+98[%]	Proportion of the delay sound that is to be returned to the input of delay 1 (negative (-) values invert the phase)
Delay 1 HF Damp	200–8000[Hz], BYPASS	Frequency at which the high-frequency content of the delayed sound of delay 1 will be cut (BYPASS: no cut)
Delay 2 Time	0–1300[msec], note	Delay time from when sound is input to delay 2 until the delay sound is heard
Delay 2 Feedback #	-98–+98[%]	Proportion of the delay sound that is to be returned to the input of delay 2 (negative (-) values invert the phase)
Delay 2 HF Damp	200–8000[Hz], BYPASS	Frequency at which the high-frequency content of the delayed sound of delay 2 will be cut (BYPASS: no cut)
Pan #	L64–63R	Panning of the delay sound
Low Gain	-15–+15[dB]	Gain of the low range
High Gain	-15–+15[dB]	Gain of the high range
Balance #	D100:0W–D0:100W	Volume balance of the original sound (D) and delay sound (W)
Level	0–127	Output level

46: MODULATION DELAY

Adds modulation to the delayed sound.

When Feedback Mode is NORMAL:

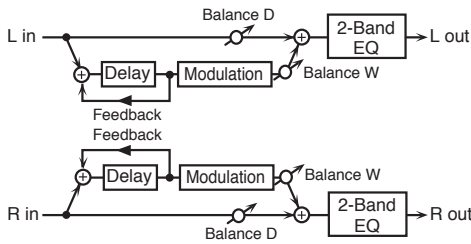

When Feedback Mode is CROSS:

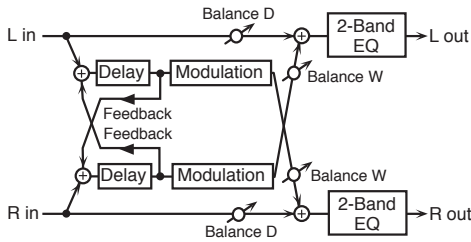

Parameter	Value	Explanation
Delay Left	0-1300[msec], note	Adjusts the time until the delay sound is heard.
Delay Right	0-1300[msec], note	Adjusts the time until the delay sound is heard.
Feedback Mode	NORMAL, CROSS	Selects the way in which delay sound is fed back into the effect (See the figures.)
Feedback #	-98-+98[%]	Adjusts the amount of the delay sound that's fed back into the effect. Negative (-) settings invert the phase.
HF Damp	200-8000[Hz], BYPASS	Adjusts the frequency above which sound fed back to the effect is filtered out. If you don't want to filter out any high frequencies, set this parameter to BYPASS.
☆ Rate #	0.05-10.00[Hz], note	Frequency of modulation
Depth	0-127	Depth of modulation
Phase	0-180[deg]	Spatial spread of the sound
Low Gain	-15-+15[dB]	Gain of the low range
High Gain	-15-+15[dB]	Gain of the high range
Balance #	D100:0W-D0:100W	Volume balance between the direct sound (D) and the delay sound (W)
Level	0-127	Output level

47: 3TAP PAN DELAY

Produces three delay sounds; center, left and right.

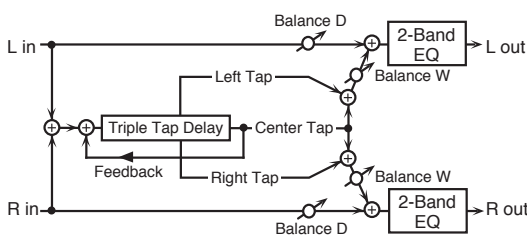

Parameter	Value	Explanation
Delay Left, Right, Center	0-2600[msec], note	Adjusts the time from the original sound until the left, right, and center delayed sounds are heard
☆ Center Feedback #	-98-+98[%]	Adjusts the amount of the delay sound that's fed back into the effect. Negative (-) settings invert the phase.
HF Damp	200-8000[Hz], BYPASS	Adjusts the frequency above which sound fed back to the effect is filtered out. If you do not want to filter out any high frequencies, set this parameter to BYPASS.
Left, Right, Center Level	0-127	Volume of each delay
Low Gain	-15-+15[dB]	Gain of the low range
High Gain	-15-+15[dB]	Gain of the high range
Balance #	D100:0W-D0:100W	Volume balance between the direct sound (D) and the delay sound (W)
Level	0-127	Output level

48: 4TAP PAN DELAY

This effect has four delays.

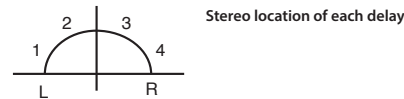
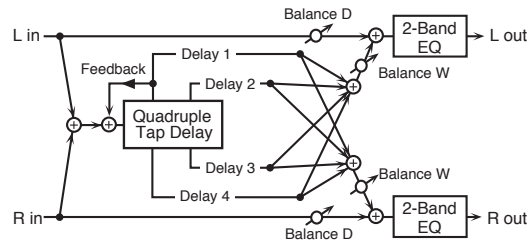

Parameter	Value	Explanation
Delay 1-4 Time	0-2600[msec], note	Adjusts the time from the original sound until delay sounds 1-4 are heard
☆ Delay 1 Feedback #	-98-+98[%]	Adjusts the amount of the delay sound that's fed back into the effect. Negative (-) settings invert the phase.
HF Damp	200-8000[Hz], BYPASS	Adjusts the frequency above which sound fed back to the effect is filtered out. If you do not want to filter out any high frequencies, set this parameter to BYPASS.
Delay 1-4 Level	0-127	Volume of each delay
Low Gain	-15-+15[dB]	Gain of the low range
High Gain	-15-+15[dB]	Gain of the high range
Balance #	D100:0W-D0:100W	Volume balance between the direct sound (D) and the delay sound (W)
Level	0-127	Output level

49: MULTI TAP DELAY

This effect provides four delays. Each of the Delay Time parameters can be set to a note length based on the selected tempo. You can also set the panning and level of each delay sound.

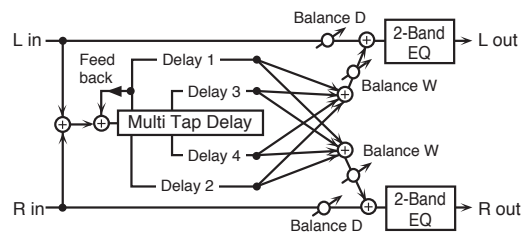

Parameter	Value	Explanation
Delay 1-4 Time	0-2600[msec], note	Adjusts the time until Delays 1-4 are heard.
☆ Delay 1 Feedback #	-98-+98[%]	Adjusts the amount of the delay sound that's fed back into the effect. Negative (-) settings invert the phase.
HF Damp	200-8000[Hz], BYPASS	Adjusts the frequency above which sound fed back to the effect is filtered out. If you do not want to filter out any the high frequencies, set this parameter to BYPASS.
Delay 1-4 Pan	L64-63R	Stereo location of Delays 1-4
Delay 1-4 Level	0-127	Output level of Delays 1-4
Low Gain	-15-+15[dB]	Gain of the low range
High Gain	-15-+15[dB]	Gain of the high range
Balance #	D100:0W-D0:100W	Volume balance between the direct sound (D) and the effect sound (W)
Level	0-127	Output level

50: REVERSE DELAY

This is a reverse delay that adds a reversed and delayed sound to the input sound. A tap delay is connected immediately after the reverse delay.

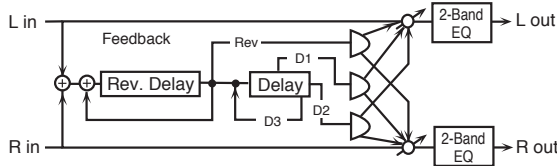

Parameter	Value	Explanation
Threshold	0-127	Volume at which the reverse delay will begin to be applied
Rev Delay Time	0-1300[msec], note	Delay time from when sound is input into the reverse delay until the delay sound is heard
☆ Rev Delay Feedback #	-98-+98[%]	Proportion of the delay sound that is to be returned to the input of the reverse delay (negative (-) values invert the phase)
Rev Delay HF Damp	200-8000[Hz], BYPASS	Frequency at which the high-frequency content of the reverse-delayed sound will be cut (BYPASS: no cut)
Rev Delay Pan	L64-63R	Panning of the reverse delay sound
Rev Delay Level	0-127	Volume of the reverse delay sound
Delay 1-3 Time	0-1300[msec], note	Delay time from when sound is input into the tap delay until the delay sound is heard
Delay 3 Feedback #	-98-+98[%]	Proportion of the delay sound that is to be returned to the input of the tap delay (negative (-) values invert the phase)
Delay HF Damp	200-8000[Hz], BYPASS	Frequency at which the hi-frequency content of the tap delay sound will be cut (BYPASS: no cut)
Delay 1 Pan, Delay 2 Pan	L64-63R	Panning of the tap delay sounds
Delay 1 Level, Delay 2 Level	0-127	Volume of the tap delay sounds
Low Gain	-15-+15[dB]	Gain of the low range
High Gain	-15-+15[dB]	Gain of the high range
Balance #	D100:0W-D0:100W	Volume balance of the original sound (D) and delay sound (W)
Level	0-127	Output level

51: SHUFFLE DELAY

Adds a shuffle to the delay sound, giving the sound a bouncy delay effect with a swing feel.

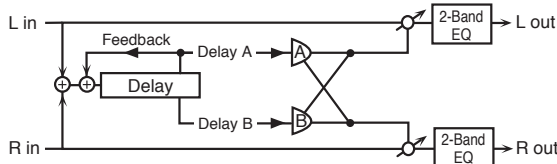

Parameter	Value	Explanation
☆ Delay Time #	0-2600[msec], note	Adjusts the time until the delay sound is heard.
Shuffle Rate #	0-100	Adjusts the ratio (as a percentage) of the time that elapses before Delay B sounds relative to the time that elapses before the Delay A sounds. When set to 100, the delay times are the same.
Acceleration	0-15	Adjusts the speed which the Delay Time changes from the current setting to its specified new setting.
Feedback #	-98-+98[%]	Adjusts the amount of the delay that's feedback into the effect. Negative (-) settings invert the phase.
HF Damp	200-8000[Hz], BYPASS	Adjusts the frequency above which sound fed back to the effect is filtered out. If you don't want to filter out any high frequencies, set this parameter to BYPASS.
Pan A, B	L64-63R	Stereo location of Delay A/B
Level A, B	0-127	Volume of delay A/B
Low Gain	-15-+15[dB]	Gain of the low range
High Gain	-15-+15[dB]	Gain of the high range
Balance #	D100:0W-D0:100W	Volume balance between the direct sound (D) and the effect sound (W)
Level	0-127	Output level

52: 3D DELAY

This applies a 3D effect to the delay sound. The delay sound will be positioned 90 degrees left and 90 degrees right.

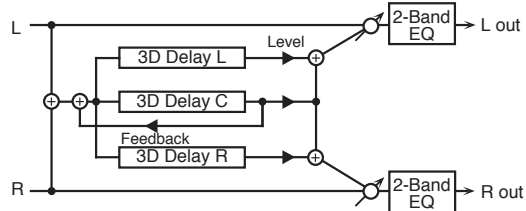

Parameter	Value	Explanation
Delay Left		
Delay Right	0-2600[msec], note	Adjusts the delay time from the direct sound until the delay sound is heard.
Delay Center		
☆ Center Feedback #	-98-+98[%]	Adjusts the proportion of the delay sound that is fed back into the effect. Negative (-) settings will invert the phase.
HF Damp	200-8000[Hz], BYPASS	Adjusts the frequency above which sound fed back to the effect will be cut. If you do not want to cut the high frequencies, set this parameter to BYPASS.
Left Level		
Right Level	0-127	Output level of the delay sound
Center Level		
Output Mode		The optimal 3D effect will be achieved.
	SPEAKER	When using speakers
	PHONES	When using headphones
Low Gain	-15-+15[dB]	Gain of the low range
High Gain	-15-+15[dB]	Gain of the high range
Balance #	D100:0W-D0:100W	Volume balance between the direct sound (D) and the effect sound (W)
Level	0-127	Output level

53: ANALOG DELAY

A stereo delay in which the delay time can be varied smoothly.

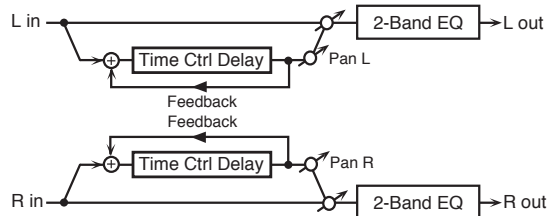

Parameter	Value	Explanation
☆ Delay Time #	0-1300[msec], note	Adjusts the time until the delay is heard.
Acceleration	0-15	Adjusts the speed which the Delay Time changes from the current setting to a specified new setting. The rate of change for the Delay Time directly affects the rate of pitch change.
Feedback #	-98-+98[%]	Adjusts the amount of the delay that's fed back into the effect. Negative (-) settings invert the phase.
HF Damp	200-8000[Hz], BYPASS	Adjusts the frequency above which sound fed back to the effect is filtered out. If you do not want to filter out any high frequencies, set this parameter to BYPASS.
Low Gain	-15-+15[dB]	Gain of the low range
High Gain	-15-+15[dB]	Gain of the high range
Balance #	D100:0W-D0:100W	Volume balance between the direct sound (D) and the delay sound (W)
Level	0-127	Output level

54: ANALOG LONG DELAY

A delay in which the delay time can be varied smoothly, and allowing an extended delay to be produced.

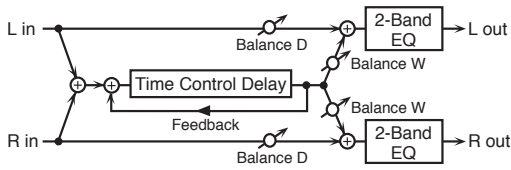

Parameter	Value	Explanation
☆ Delay Time #	0-2600[msec], note	Adjusts the time until the delay is heard.
Acceleration	0-15	Adjusts the speed which the Delay Time changes from the current setting to a specified new setting. The rate of change for the Delay Time directly affects the rate of pitch change.
Feedback #	-98-+98[%]	Adjusts the amount of the delay that's fed back into the effect. Negative (-) settings invert the phase.
HF Damp	200-8000[Hz], BYPASS	Adjusts the frequency above which sound fed back to the effect is filtered out. If you do not want to filter out any high frequencies, set this parameter to BYPASS.
Pan #	L64-63R	Stereo location of the delay
Low Gain	-15-+15[dB]	Gain of the low range
High Gain	-15-+15[dB]	Gain of the high range
Balance #	D100:0W-D0:100W	Volume balance between the direct sound (D) and the delay sound (W)
Level	0-127	Output level

55: TAPE ECHO

A virtual tape echo that produces a realistic tape delay sound. This simulates the tape echo section of a Roland RE-201 Space Echo.

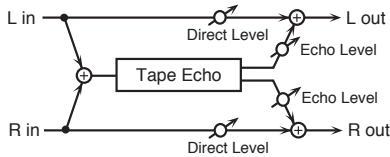

Parameter	Value	Explanation
Mode	S, M, L, S+M, S+L, M+L, S+M+L	Combination of playback heads to use. Select from three different heads with different delay times. S: short, M: middle, L: long
☆ Repeat Rate #	0-127	Tape speed. Increasing this value will shorten the spacing of the delayed sounds.
Intensity #	0-127	Amount of delay repeats
Bass	-15-+15[dB]	Boost/cut for the lower range of the echo sound
Treble	-15-+15[dB]	Boost/cut for the upper range of the echo sound
Head S Pan	L64-63R	Independent panning for the short, middle, and long playback heads
Head M Pan		
Head L Pan		
Tape Distortion	0-5	Amount of tape-dependent distortion to be added. This simulates the slight tonal changes that can be detected by signal-analysis equipment. Increasing this value will increase the distortion.
Wow/Flutter Rate	0-127	Speed of wow/flutter (complex variation in pitch caused by tape wear and rotational irregularity)
Wow/Flutter Depth	0-127	Depth of wow/flutter
Echo Level #	0-127	Volume of the echo sound
Direct Level #	0-127	Volume of the original sound
Level	0-127	Output level

56: LOFI NOISE

In addition to a lo-fi effect, this adds various types of noise such as white noise and disc noise.

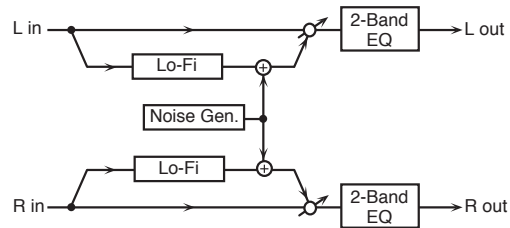

Parameter	Value	Explanation
LoFi Type	1-9	Degrades the sound quality. The sound quality grows poorer as this value is increased.
Post Filter Type	OFF	No filter is used
	LPF	Cuts the frequency range above the Cutoff.
	HPF	Cuts the frequency range below the Cutoff.
Post Filter Cutoff	200-8000[Hz]	Center frequency of the filter
W/P Noise Type	WHITE, PINK	Switch between white noise and pink noise.
W/P Noise LPF	200-8000[Hz], BYPASS	Center frequency of the low pass filter applied to the white/pink noise (BYPASS: no cut)
W/P Noise Level #	0-127	Volume of the white/pink noise
Disc Noise Type	LP, EP, SP, RND	Type of record noise. The frequency at which the noise is heard depends on the selected type.
Disc Noise LPF	200-8000[Hz], BYPASS	Adjusts the cutoff frequency of the low pass filter applied to the record noise. If you don't want to filter out any high frequencies, set this parameter to BYPASS.
Disc Noise Level #	0-127	Volume of the record noise
Hum Noise Type	50, 60[Hz]	Frequency of the hum noise
Hum Noise LPF	200-8000[Hz], BYPASS	Center frequency of the low pass filter applied to the hum noise (BYPASS: no cut)
Hum Noise Level #	0-127	Volume of the hum noise
Low Gain	-15-+15[dB]	Gain of the low range
High Gain	-15-+15[dB]	Gain of the high range
☆ Balance #	D100:0W-D0:100W	Volume balance between the direct sound (D) and the effect sound (W)
Level	0-127	Output level

57: LOFI COMPRESS

This is an effect that intentionally degrades the sound quality for creative purposes.

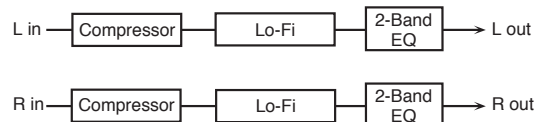

Parameter	Value	Explanation
Pre Filter Type	1	Compressor off
	2-6	Compressor on
LoFi Type	1-9	Degrades the sound quality. The sound quality grows poorer as this value is increased.
Post Filter Type	OFF	No filter is used
	LPF	Cuts the frequency range above the Cutoff
	HPF	Cuts the frequency range below the Cutoff
Post Filter Cutoff	200-8000[Hz]	Basic frequency of the Post Filter
Low Gain	-15-+15[dB]	Gain of the low range
High Gain	-15-+15[dB]	Gain of the high range
☆ Balance #	D100:0W-D0:100W	Volume balance between the direct sound (D) and the effect sound (W)
Level #	0-127	Output level

58: LOFI RADIO

In addition to a Lo-Fi effect, this effect also generates radio noise.

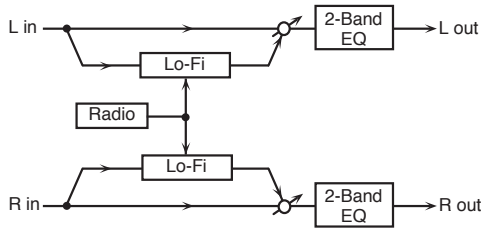

Parameter	Value	Explanation
LoFi Type	1-9	Degrades the sound quality. The sound quality grows poorer as this value is increased.
Post Filter Type	Type of filter	
	OFF	No filter is used
	LPF	Cuts the frequency range above the Cutoff.
	HPF	Cuts the frequency range below the Cutoff.
Post Filter Cutoff	200-8000[Hz]	Basic frequency of the Post Filter
☆ Radio Detune #	0-127	Simulates the tuning noise of a radio. As this value is raised, the tuning drifts further.
Radio Noise Level #	0-127	Volume of the radio noise
Low Gain	-15-+15[dB]	Gain of the low range
High Gain	-15-+15[dB]	Gain of the high range
Balance #	D100:0W-D0:100W	Volume balance between the direct sound (D) and the effect sound (W)
Level	0-127	Output level

59: TELEPHONE

This effect produces a muffled sound, like that heard through a telephone.

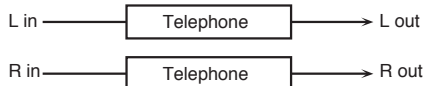

Parameter	Value	Explanation
☆ Voice Quality #	0-15	Audio quality of the telephone voice
Treble	-15-+15[dB]	Bandwidth of the telephone voice
Balance #	D100:0W-D0:100W	Volume balance between the direct sound (D) and the effect sound (W)
Level	0-127	Output level

60: PHONOGRAPH

Simulates a sound recorded on an analog record and played back on a record player. This effect also simulates the various types of noise that are typical of a record, and even the rotational irregularities of an old turntable.

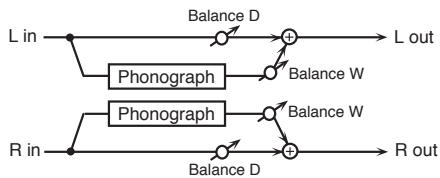

Parameter	Value	Explanation
Signal Distortion	0-127	Depth of distortion
Frequency Range	0-127	Frequency response of the playback system. Decreasing this value will produce the impression of an old system with a poor frequency response.
Disc Type	LP, EP, SP	Rotational speed of the turntable. This will affect the frequency of the scratch noise.
Scratch Noise Level	0-127	Amount of noise due to scratches on the record
Dust Noise Level	0-127	Volume of noise due to dust on the record
Hiss Noise Level	0-127	Volume of continuous "hiss"
Total Noise Level #	0-127	Volume of overall noise
Wow	0-127	Depth of long-cycle rotational irregularity
Flutter	0-127	Depth of short-cycle rotational irregularity
Random	0-127	Depth of indefinite-cycle rotational irregularity
☆ Total Wow/Flutter #	0-127	Depth of overall rotational irregularity
Balance #	D100:0W-D0:100W	Volume balance between the direct sound (D) and the effect sound (W)
Level	0-127	Output level

61: PITCH SHIFTER

A stereo pitch shifter.

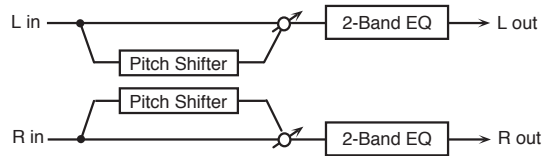

Parameter	Value	Explanation
☆ Coarse #1	-24-+12[semi]	Adjusts the pitch of the pitch shifted sound in semitone steps.
Fine #1	-100-+100[cent]	Adjusts the pitch of the pitch shifted sound in 2-cent steps.
Delay Time	0-1300[msec], note	Adjusts the delay time from the direct sound until the pitch shifted sound is heard.
Feedback #	-98-+98[%]	Adjusts the proportion of the pitch shifted sound that is fed back into the effect. Negative (-) settings will invert the phase.
Low Gain	-15-+15[dB]	Gain of the low range
High Gain	-15-+15[dB]	Gain of the high range
Balance #	D100:0W-D0:100W	Volume balance between the direct sound (D) and the pitch shifted sound (W)
Level	0-127	Output level

62: 2VOI PCH SHIFTER

Shifts the pitch of the original sound. This 2-voice pitch shifter has two pitch shifters, and can add two pitch shifted sounds to the original sound.

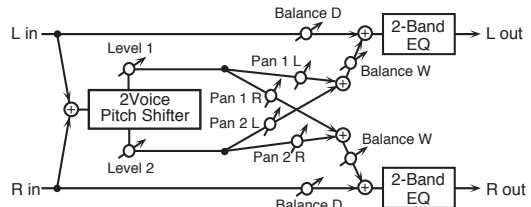

Parameter	Value	Explanation
☆ Pitch1 Coarse #1	-24-+12[semi]	Adjusts the pitch of Pitch Shift 1 in semitone steps.
Pitch1 Fine #1	-100-+100[cent]	Adjusts the pitch of Pitch Shift Pitch 1 in 2-cent steps.
Pitch1 Delay	0-1300[msec], note	Adjusts the delay time from the direct sound until the Pitch Shift 1 sound is heard.
Pitch1 Feedback #	-98-+98[%]	Adjusts the proportion of the pitch shifted sound that is fed back into the effect. Negative (-) settings will invert the phase.
Pitch1 Pan #	L64-63R	Stereo location of the Pitch Shift 1 sound
Pitch1 Level	0-127	Volume of the Pitch Shift1 sound
Pitch2 Coarse #2	-24-+12[semi]	Settings of the Pitch Shift 2 sound. The parameters are the same as for the Pitch Shift 1 sound.
Pitch2 Fine #2	-100-+100[cent]	
Pitch2 Delay	0-1300[msec], note	
Pitch2 Feedback #	-98-+98[%]	
Pitch2 Pan #	L64-63R	
Pitch2 Level	0-127	
Low Gain	-15-+15[dB]	Gain of the low range
High Gain	-15-+15[dB]	Gain of the high range
Balance #	D100:0W-D0:100W	Volume balance between the direct sound (D) and the pitch shifted sound (W)
Level	0-127	Output level

63: STEP PCH SHIFTER

A pitch shifter in which the amount of pitch shift is varied by a 16-step sequence.

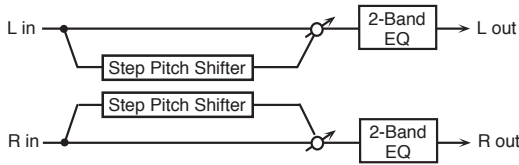

Parameter	Value	Explanation
Step 01-16	-24+12[semi]	Amount of pitch shift at each step (semitone units)
Rate #	0.05-10.0[Hz], note	Rate at which the 16-step sequence will cycle
Attack #	0-127	Speed at which the amount of pitch shift changes between steps
☆ Gate Time #	0-127	Duration of the pitch shifted sound at each step
Fine	-100+100[cent]	Pitch shift adjustment for all steps (2-cent units)
Delay Time	0-1300[msec], note	Delay time from the original sound until the pitch-shifted sound is heard
Feedback #	-98+98[%]	Proportion of the pitch-shifted sound that is to be returned to the input (negative (-) values invert the phase)
Low Gain	-15+15[dB]	Gain of the low range
High Gain	-15+15[dB]	Gain of the high range
Balance #	D100:0W-D0:100W	Volume balance of the original sound (D) and pitch-shifted sound (W)
Level	0-127	Output level

MEMO

You can use MFX control to restart the step sequence from the beginning (p. 18, p. 24).

64: REVERB

Adds reverberation to the sound, simulating an acoustic space.

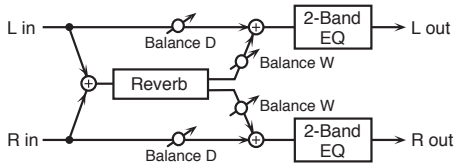

Parameter	Value	Explanation
Type	Type of reverb	
	ROOM1	Dense reverb with short decay
	ROOM2	Sparse reverb with short decay
	STAGE1	Reverb with greater late reverberation
	STAGE2	Reverb with strong early reflections
	HALL1	Reverb with clear reverberance
HALL2	Reverb with rich reverberance	
Pre Delay	0.0-100[msec]	Adjusts the delay time from the direct sound until the reverb sound is heard.
☆ Time #	0-127	Time length of reverberation
HF Damp	200-8000[Hz], BYPASS	Adjusts the frequency above which the reverberant sound will be cut. As the frequency is set lower, more of the high frequencies will be cut, resulting in a softer and more muted reverberance. If you do not want to cut the high frequencies, set this parameter to BYPASS.
Low Gain	-15+15[dB]	Gain of the low range
High Gain	-15+15[dB]	Gain of the high range
Balance #	D100:0W-D0:100W	Volume balance between the direct sound (D) and the reverb sound (W)
Level	0-127	Output level

65: GATED REVERB

This is a special type of reverb in which the reverberant sound is cut off before its natural length.

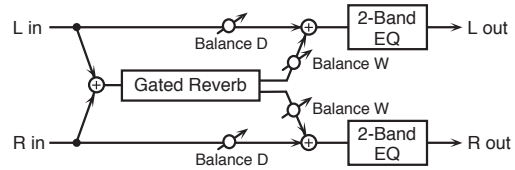

Parameter	Value	Explanation
Type	Type of reverb	
	NORMAL	Conventional gated reverb
	REVERSE	Backwards reverb
	SWEEP1	The reverberant sound moves from right to left
SWEEP2	The reverberant sound moves from left to right	
Pre Delay	0.0-100[msec]	Adjusts the delay time from the direct sound until the reverb sound is heard.
Gate Time	5-500[msec]	Adjusts the delay time from when the reverb is heard until it disappears.
Low Gain	-15+15[dB]	Gain of the low range
High Gain	-15+15[dB]	Gain of the high range
☆ Balance #	D100:0W-D0:100W	Volume balance between the direct sound (D) and the reverb sound (W)
Level #	0-127	Output level

66: OD → CHORUS

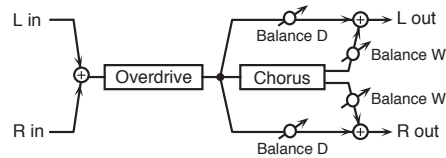

Parameter	Value	Explanation
Overdrive Drive #	0-127	Degree of distortion. Also changes the volume.
Overdrive Pan #	L64-63R	Stereo location of the overdrive sound
Chorus Pre Delay	0.0-100[msec]	Adjusts the delay time from the direct sound until the chorus sound is heard.
☆ Chorus Rate #	0.05-10.00[Hz], note	Frequency of modulation
Chorus Depth	0-127	Depth of modulation
Chorus Balance #	D100:0W-D0:100W	Adjusts the volume balance between the sound that is sent through the chorus (W) and the sound that is not sent through the chorus (D).
Level	0-127	Output level

67: OD → FLANGER

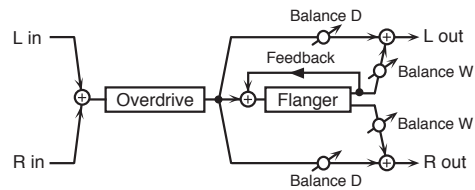

Parameter	Value	Explanation
Overdrive Drive #	0-127	Degree of distortion. Also changes the volume.
Overdrive Pan #	L64-63R	Stereo location of the overdrive sound
Flanger Pre Delay	0.0-100[msec]	Adjusts the delay time from when the direct sound begins until the flanger sound is heard.
☆ Flanger Rate #	0.05-10.00[Hz], note	Frequency of modulation
Flanger Depth	0-127	Depth of modulation
Flanger Feedback #	-98+98[%]	Adjusts the proportion of the flanger sound that is fed back into the effect. Negative (-) settings will invert the phase.
Flanger Balance #	D100:0W-D0:100W	Adjusts the volume balance between the sound that is sent through the flanger (W) and the sound that is not sent through the flanger (D).
Level	0-127	Output level

68: OD → DELAY

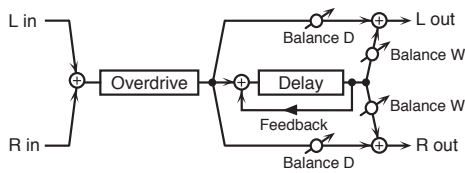

Parameter	Value	Explanation
Overdrive Drive #	0–127	Degree of distortion Also changes the volume.
Overdrive Pan #	L64–63R	Stereo location of the overdrive sound
Delay Time	0–2600[msec], note	Adjusts the delay time from the direct sound until the delay sound is heard.
☆ Delay Feedback #	-98–+98[%]	Adjusts the proportion of the delay sound that is fed back into the effect. Negative (-) settings will invert the phase.
Delay HF Damp	200–8000[Hz], note	Adjusts the frequency above which sound fed back to the effect will be cut. If you do not want to cut the high frequencies, set this parameter to BYPASS.
Delay Balance #	D100:0W–D0:100W	Adjusts the volume balance between the sound that is sent through the delay (W) and the sound that is not sent through the delay (D).
Level	0–127	Output level

69: DST → CHORUS

The parameters are essentially the same as in “66: OD → CHORUS” with the exception of the following two.

Overdrive Drive → Distortion Drive,
Overdrive Pan → Distortion Pan

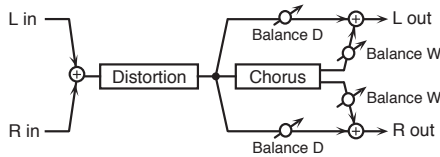

70: DST → FLANGER

The parameters are essentially the same as in “67: OD → FLANGER,” with the exception of the following two.

Overdrive Drive → Distortion Drive,
Overdrive Pan → Distortion Pan

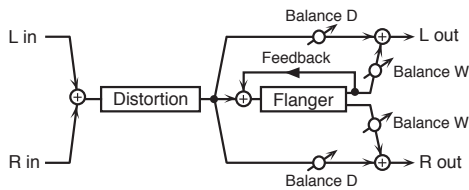

71: DST → DELAY

The parameters are essentially the same as in “68: OD → DELAY,” with the exception of the following two.

Overdrive Drive → Distortion Drive,
Overdrive Pan → Distortion Pan

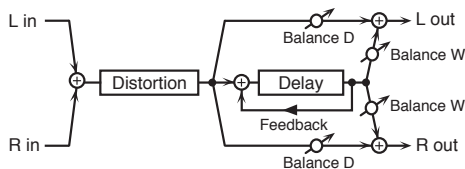

72: ENH → CHORUS

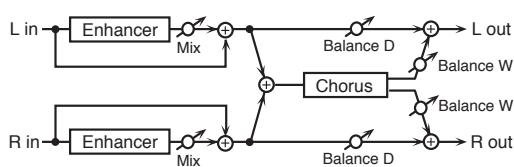

Parameter	Value	Explanation
Enhancer Sens #	0–127	Sensitivity of the enhancer
Enhancer Mix #	0–127	Level of the overtones generated by the enhancer
Chorus Pre Delay	0.0–100[msec]	Adjusts the delay time from the direct sound until the chorus sound is heard.
☆ Chorus Rate #	0.05–10.00[Hz], note	Frequency of modulation
Chorus Depth	0–127	Depth of modulation
Chorus Balance #	D100:0W–D0:100W	Adjusts the volume balance between the sound that is sent through the chorus (W) and the sound that is not sent through the chorus (D).
Level	0–127	Output level

73: ENH → FLANGER

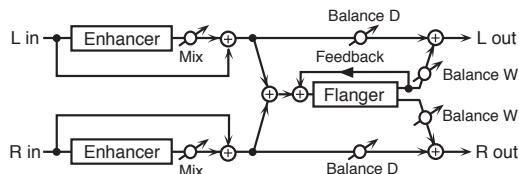

Parameter	Value	Explanation
Enhancer Sens #	0–127	Sensitivity of the enhancer
Enhancer Mix #	0–127	Level of the overtones generated by the enhancer
Flanger Pre Delay	0.0–100[msec]	Adjusts the delay time from when the direct sound begins until the flanger sound is heard.
☆ Flanger Rate #	0.05–10.00[Hz], note	Frequency of modulation
Flanger Depth	0–127	Depth of modulation
Flanger Feedback #	-98–+98[%]	Adjusts the proportion of the flanger sound that is fed back into the effect. Negative (-) settings will invert the phase.
Flanger Balance #	D100:0W–D0:100W	Adjusts the volume balance between the sound that is sent through the flanger (W) and the sound that is not sent through the flanger (D).
Level	0–127	Output level

74: ENH → DELAY

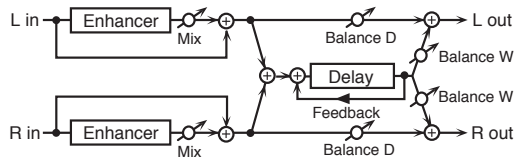

Parameter	Value	Explanation
Enhancer Sens #	0–127	Sensitivity of the enhancer
Enhancer Mix #	0–127	Level of the overtones generated by the enhancer
Delay Time	0–2600[msec], note	Adjusts the delay time from the direct sound until the delay sound is heard.
☆ Delay Feedback #	-98–+98[%]	Adjusts the proportion of the delay sound that is fed back into the effect. Negative (-) settings will invert the phase.
Delay HF Damp	200–8000[Hz], BYPASS	Adjusts the frequency above which sound fed back to the effect will be cut. If you do not want to cut the high frequencies, set this parameter to BYPASS.
Delay Balance #	D100:0W–D0:100W	Adjusts the volume balance between the sound that is sent through the delay (W) and the sound that is not sent through the delay (D).
Level	0–127	Output level

75: CHORUS → DELAY

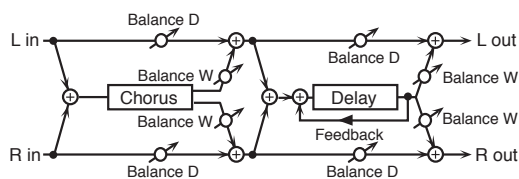

Parameter	Value	Explanation
Chorus Pre Delay	0.0–100[msec]	Adjusts the delay time from the direct sound until the chorus sound is heard.
☆ Chorus Rate #	0.05–10.00[Hz], note	Frequency of modulation
Chorus Depth	0–127	Depth of modulation
Chorus Balance #	D100:0W–D0:100W	Volume balance between the direct sound (D) and the chorus sound (W)
Delay Time	0–2600[msec], note	Adjusts the delay time from the direct sound until the delay sound is heard.

Parameter	Value	Explanation
Delay Feedback #	-98~+98[%]	Adjusts the proportion of the delay sound that is fed back into the effect. Negative (-) settings will invert the phase.
Delay HF Damp	200-8000[Hz], BYPASS	Adjusts the frequency above which sound fed back to the effect will be cut. If you do not want to cut the high frequencies, set this parameter to BYPASS.
Delay Balance #	D100:0W-D0:100W	Adjusts the volume balance between the sound that is sent through the delay (W) and the sound that is not sent through the delay (D).
Level	0-127	Output level

76: FLANGER → DELAY

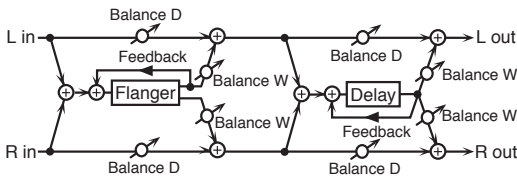

Parameter	Value	Explanation
Flanger Pre Delay	0.0-100[msec]	Adjusts the delay time from when the direct sound begins until the flanger sound is heard.
☆ Flanger Rate #	0.05-10.00[Hz], note	Frequency of modulation
Flanger Depth	0-127	Depth of modulation
Flanger Feedback #	-98~+98[%]	Adjusts the proportion of the flanger sound that is fed back into the effect. Negative (-) settings will invert the phase.
Flanger Balance #	D100:0W-D0:100W	Volume balance between the direct sound (D) and the flanger sound (W)
Delay Time	0-2600[msec], note	Adjusts the delay time from the direct sound until the delay sound is heard.
Delay Feedback #	-98~+98[%]	Adjusts the proportion of the delay sound that is fed back into the effect. Negative (-) settings will invert the phase.
Delay HF Damp	200-8000[Hz], note	Adjusts the frequency above which sound fed back to the effect will be cut. If you do not want to cut the high frequencies, set this parameter to BYPASS.
Delay Balance #	D100:0W-D0:100W	Adjusts the volume balance between the sound that is sent through the delay (W) and the sound that is not sent through the delay (D).
Level	0-127	Output level

77: CHORUS → FLANGER

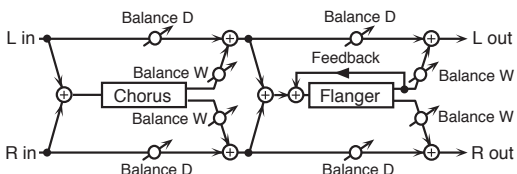

Parameter	Value	Explanation
Chorus Pre Delay	0.0-100[msec]	Adjusts the delay time from the direct sound until the chorus sound is heard.
Chorus Rate #	0.05-10.00[Hz], note	Modulation frequency of the chorus effect
Chorus Depth	0-127	Modulation depth of the chorus effect
☆ Chorus Balance #	D100:0W-D0:100W	Volume balance between the direct sound (D) and the chorus sound (W)
Flanger Pre Delay	0.0-100[msec]	Adjusts the delay time from when the direct sound begins until the flanger sound is heard.
Flanger Rate #	0.05-10.00[Hz], note	Modulation frequency of the flanger effect
Flanger Depth	0-127	Modulation depth of the flanger effect
Flanger Feedback #	-98~+98[%]	Adjusts the proportion of the flanger sound that is fed back into the effect. Negative (-) settings will invert the phase.
Flanger Balance #	D100:0W-D0:100W	Adjusts the volume balance between the sound that is sent through the flanger (W) and the sound that is not sent through the flanger (D).
Level	0-127	Output level

78: SYMPATHETIC RESO

On an acoustic piano, holding down the damper pedal allows other strings to resonate in sympathy with the notes you play, creating rich and spacious resonances. This effect simulates these sympathetic resonances.

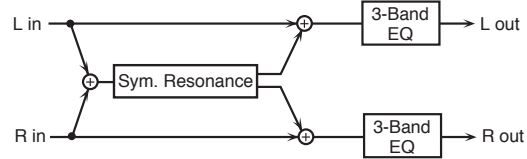

Parameter	Value	Explanation
☆ Depth #	0-127	Depth of the effect
Damper #	0-127	Depth to which the damper pedal is pressed (controls the resonant sound)
Pre LPF	16-15000[Hz], BYPASS	Frequency of the filter that cuts the high-frequency content of the input sound (BYPASS: no cut)
Pre HPF	BYPASS, 16-15000[Hz]	Frequency of the filter that cuts the low-frequency content of the input sound (BYPASS: no cut)
Peaking Freq	200-8000[Hz]	Frequency of the filter that boosts/cuts a specific frequency region of the input sound
Peaking Gain	-15~+15[dB]	Amount of boost/cut produced by the filter at the specified frequency region of the input sound
Peaking Q	0.5, 1.0, 2.0, 4.0, 8.0	Width of the frequency region boosted/cut by the Peaking Gain parameter (larger values make the region narrower)
HF Damp	16-15000[Hz], BYPASS	Frequency at which the high-frequency content of the resonant sound will be cut (BYPASS: no cut)
LF Damp	BYPASS, 16-15000[Hz]	Frequency at which the low-frequency content of the resonant sound will be cut (BYPASS: no cut)
Lid	1-6	This simulates the actual changes in sound that occur when the lid of a grand piano is set at different heights.
EQ Low Freq	200, 400[Hz]	Frequency of the low-range EQ
EQ Low Gain	-15~+15[dB]	Amount of low-range boost/cut
EQ Mid Freq	200-8000[Hz]	Frequency of the midrange EQ
EQ Mid Gain	-15~+15[dB]	Amount of midrange boost/cut
EQ Mid Q	0.5, 1.0, 2.0, 4.0, 8.0	Width of midrange (larger values make the region narrower)
EQ High Freq	2000, 4000, 8000[Hz]	Frequency of the high-range EQ
EQ High Gain	-15~+15[dB]	Amount of high-range boost/cut
Level	0-127	Output level

79: Di VOCODER

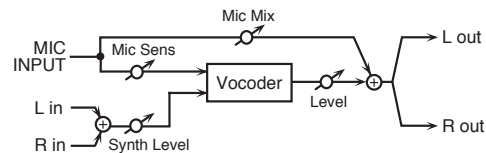

Parameter	Value	Explanation
Mic Sens #	0-127	Input sensitivity of the microphone
Synth Level #	0-127	Input level of the instrument
☆ Mic Mix #	0-127	Amount of microphone audio added to the output of the vocoder
Level	0-127	Volume level after passing through the vocoder

80: BIT CRUSHER

This creates a lo-fi sound.

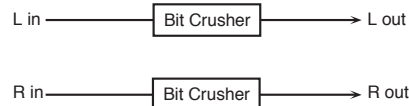

Parameter	Value	Explanation
☆ Sample Rate #	0-127	Adjusts the sample rate.
Bit Down #	0-20	Adjusts the bit depth.
Filter #	0-127	Adjusts the filter depth.
Level	0-127	Output level

Chorus Parameters

Parameter	Explanation
01: CHORUS	
Filter Type	Type of filter
	OFF No filter is used
	LPF Cuts the frequency range above the Cutoff Freq
	HPF Cuts the frequency range below the Cutoff Freq
Cutoff Freq	Basic frequency of the filter 200-8000[Hz]
Pre Delay	Adjusts the delay time from the direct sound until the chorus sound is heard. 0.0-100.0[msec]
Rate	Frequency of modulation 0.05-10.00Hz, note
Depth	Depth of modulation 0-127
Phase	Spatial spread of the sound 0-180[deg]
Feedback	Adjusts the amount of the chorus sound that is fed back into the effect. 0-127
02: DELAY	
Delay Left, Right, Center	Adjusts the delay time from the direct sound until the delay sound is heard. 0-1000ms, note
Center Feedback	Adjusts the proportion of the delay sound that is fed back into the effect. Negative (-) settings will invert the phase. -98-+98[%]
HF Damp	Adjusts the frequency above which sound fed back to the effect will be cut. If you do not want to cut the high frequencies, set this parameter to BYPASS. 200-8000[Hz], BYPASS
Left, Right, Center Level	Volume of each delay sound 0-127
03: GM2 CHORUS	
Pre-LPF	Cuts the high frequency range of the sound coming into the chorus. 0-7
Level	Volume of the chorus sound 0-127
Feedback	Adjusts the amount of the chorus sound that is fed back into the effect. 0-127
Rate	Frequency of modulation 0-127
Depth	Depth of modulation 0-127
Send Level To Rev	Adjusts the amount of chorus sound that will be sent to the reverb. 0-127

Reverb Parameters

Parameter	Explanation
01: REVERB	
Type	Type of reverb/delay
	ROOM1 Short reverb with high density
	ROOM2 Short reverb with low density
	STAGE1 Reverb with greater late reverberation
	STAGE2 Reverb with strong early reflections
	HALL1 Very clear-sounding reverb
	HALL2 Rich reverb
	DELAY Conventional delay effect
PAN-DELAY Delay effect with echoes that pan left and right	
Time	Time length of reverberation (Type: ROOM1-HALL2) Delay time (Type: DELAY, PAN-DELAY) 0-127
HF Damp	Adjusts the frequency above which the high-frequency content of the reverb sound will be cut, or "damped." If you do not want to cut the high frequencies, set this parameter to BYPASS. 200-8000[Hz], BYPASS
Delay Feedback	Adjusts the amount of delay feedback when the Type setting is DELAY or PAN-DELAY. Amount of delay sound returned to the input (this setting is valid only if Type is DELAY or PAN-DELAY) 0-127
02: SRV ROOM / 03: SRV HALL / 04: SRV PLATE	
Pre Delay	Adjusts the delay time from the direct sound until the reverb sound is heard. 0.0-100.0[msec]
Time	Time length of reverberation 0-127
Size	Size of the simulated room or hall 1-8
High Cut	Adjusts the frequency above which the high-frequency content of the reverb will be reduced. If you do not want to reduce the high frequencies, set this parameter to BYPASS. 160-12500[Hz], BYPASS
Density	Density of reverb 0-127
Diffusion	Adjusts the change in the density of the reverb over time. The higher the value, the more the density increases with time. (The effect of this setting is most pronounced with long reverb times.) 0-127
LF Damp Freq	Adjusts the frequency below which the low-frequency content of the reverb sound will be reduced, or "damped." 50-4000[Hz]
LF Damp Gain	Adjusts the amount of damping applied to the frequency range selected with LF Damp. With a setting of "0," there will be no reduction of the reverb's low-frequency content. -36-0[dB]
HF Damp Freq	Adjusts the frequency above which the high-frequency content of the reverb sound will be reduced, or "damped." 4000-12500[Hz]
HF Damp Gain	Adjusts the amount of damping applied to the frequency range selected with HF Damp. With a setting of "0," there will be no reduction of the reverb's high-frequency content. -36-0[dB]
05: GM2 REVERB	
Character	Type of reverb
	0-5 Reverb 6, 7 Delay
Pre-LPF	Cuts the high frequency range of the sound coming into the reverb. 0-7
Level	Output level of reverberation 0-127
Time	Time length of reverberation 0-127
Delay Feedback	Adjusts the amount of the delay sound that is fed back into the effect when the Reverb Character setting is 6 or 7. 0-127

Waveform List

INTA

No.	Name	No.	Name	No.	Name	No.	Name	No.	Name
0001	Ult.P*mp A L	0080	HM-Pno* C R	0159	Reg.Clav B	0238	Funk Gtr C	0317	Slp.E.BassA
0002	Ult.P*mp A R	0081	HM-Pno* C M	0160	Reg.Clav C	0239	Funk MtGtr A	0318	Slp.E.BassB
0003	Ult.P*mp A M	0082	HM-Pno A L	0161	Retro Clav A	0240	Funk MtGtr B	0319	Slp.E.BassC
0004	Ult.P*mp B L	0083	HM-Pno A R	0162	Retro Clav B	0241	Funk MtGtr C	0320	Pul.E.BassA
0005	Ult.P*mp B R	0084	HM-Pno A M	0163	Retro Clav C	0242	Nasty Gtr	0321	Pul.E.BassB
0006	Ult.P*mp B M	0085	HM-Pno B L	0164	Tight Clav A	0243	Overdrive1 A	0322	Pul.E.BassC
0007	Ult.P*mp C L	0086	HM-Pno B R	0165	Tight Clav B	0244	Overdrive1 C	0323	Jungle Bass
0008	Ult.P*mp C R	0087	HM-Pno B M	0166	Tight Clav C	0245	Distortion1A	0324	Garage Bass
0009	Ult.P*mp C M	0088	HM-Pno C L	0167	Hard Clav A	0246	Distortion1B	0325	SH-101 Bs A
0010	Ult.P*ff A L	0089	HM-Pno C R	0168	Hard Clav B	0247	Distortion1C	0326	SH-101 Bs B
0011	Ult.P*ff A R	0090	HM-Pno C M	0169	Hard Clav C	0248	Dist Chord A	0327	SH-101 Bs C
0012	Ult.P*ff A M	0091	HM-Pno L+	0170	ClavMtRls DB	0249	Dist Chord B	0328	MG Bass 1 A
0013	Ult.P*ff B L	0092	HM-Pno R+	0171	Harpsi A	0250	Dist Chord C	0329	MG Bass 1 B
0014	Ult.P*ff B R	0093	JD Piano 1 A	0172	Harpsi B	0251	E.Gtr Harm	0330	MG Bass 1 C
0015	Ult.P*ff B M	0094	JD Piano 1 B	0173	Harpsi C	0252	Harp A	0331	MG Bass 2
0016	Ult.P*ff C L	0095	JD Piano 1 C	0174	JLOrg Slow L	0253	Harp B	0332	MG Bass 3
0017	Ult.P*ff C R	0096	Piano Atk Nz	0175	JLOrg Slow R	0254	Harp C	0333	MC Bass A
0018	Ult.P*ff C M	0097	MKS Piano1 A	0176	JLOrg Fast L	0255	Banjo A	0334	MC Bass B
0019	Ult.P mp A L	0098	MKS Piano1 B	0177	JLOrg Fast R	0256	Banjo 1 B	0335	MC Bass C
0020	Ult.P mp A R	0099	MKS Piano1 C	0178	GT Organ	0257	Banjo 1 C	0336	Atk Syn Bass
0021	Ult.P mp A M	0100	Vint.EP mp A	0179	JD Full Draw	0258	Sitar 1 A	0337	Flute 1 A
0022	Ult.P mp B L	0101	Vint.EP mp B	0180	Org Basic 1	0259	Sitar 1 B	0338	Flute 1 B
0023	Ult.P mp B R	0102	Vint.EP mp C	0181	Org Basic 2	0260	Sitar 1 C	0339	Flute 1 C
0024	Ult.P mp B M	0103	Vint.EP f A	0182	Ballad Org	0261	Sitar Drn A	0340	Piccolo A
0025	Ult.P mp C L	0104	Vint.EP f B	0183	3rd Perc Org	0262	Sitar Drn B	0341	Piccolo B
0026	Ult.P mp C R	0105	Vint.EP f C	0184	Perc Organ	0263	Sitar Drn C	0342	Piccolo C
0027	Ult.P mp C M	0106	Vint.EP ff A	0185	RockOrgn1 A	0264	E.Sitar A	0343	Pan Flute
0028	Ult.P ff A L	0107	Vint.EP ff B	0186	RockOrgn1 B	0265	E.Sitar 1 B	0344	Shakuhachi 1
0029	Ult.P ff A R	0108	Vint.EP ff C	0187	RockOrgn1 C	0266	E.Sitar 1 C	0345	JD Fl Push
0030	Ult.P ff A M	0109	Stage EP p A	0188	Rtry Org A L	0267	Santur 1 A	0346	Clarinet A
0031	Ult.P ff B L	0110	Stage EP p B	0189	Rtry Org A R	0268	Santur 1 B	0347	Clarinet B
0032	Ult.P ff B R	0111	Stage EP p C	0190	Rtry Org B L	0269	Santur 1 C	0348	Clarinet C
0033	Ult.P ff B M	0112	Stage EP f A	0191	Rtry Org B R	0270	Shamisen A	0349	Oboe A
0034	Ult.P ff C L	0113	Stage EP f B	0192	Rtry Org C L	0271	Shamisen B	0350	Oboe B
0035	Ult.P ff C R	0114	Stage EP f C	0193	Rtry Org C R	0272	Shamisen C	0351	Oboe C
0036	Ult.P ff C M	0115	Tine EP p A	0194	LoFi RtryOrg	0273	Koto A	0352	E.Horn A
0037	XPr.P*mp A L	0116	Tine EP p B	0195	Vint.Org 1	0274	Koto B	0353	E.Horn B
0038	XPr.P*mp A R	0117	Tine EP p C	0196	Vint.Org 2	0275	Koto C	0354	E.Horn C
0039	XPr.P*mp A M	0118	Tine EP mf A	0197	Vint.Org 3	0276	FatAcBs p HA	0355	Bassoon A
0040	XPr.P*mp B L	0119	Tine EP mf B	0198	Vint.Org 4	0277	FatAcBs p HB	0356	Bassoon B
0041	XPr.P*mp B R	0120	Tine EP mf C	0199	Positive '8	0278	FatAcBs p HC	0357	Bassoon C
0042	XPr.P*mp B M	0121	Tine EP ff A	0200	Pipe Organ 1	0279	FatAcBs p NA	0358	Recorder A
0043	XPr.P*mp C L	0122	Tine EP ff B	0201	Cathedrl Org	0280	FatAcBs p NB	0359	Recorder B
0044	XPr.P*mp C R	0123	Tine EP ff C	0202	BrtNyl.Gtr A	0281	FatAcBs p NC	0360	Recorder C
0045	XPr.P*mp C M	0124	Dyno EP mp A	0203	BrtNyl.Gtr B	0282	FatAcBs f HA	0361	SopranoSax A
0046	XPr.P*ff A L	0125	Dyno EP mp B	0204	BrtNyl.Gtr C	0283	FatAcBs f HB	0362	SopranoSax B
0047	XPr.P*ff A R	0126	Dyno EP mp C	0205	Nylon Gtr1 A	0284	FatAcBs f HC	0363	SopranoSax C
0048	XPr.P*ff A M	0127	Dyno EP mf A	0206	Nylon Gtr1 B	0285	FatAcBs f NA	0364	Soft Alto A
0049	XPr.P*ff B L	0128	Dyno EP mf B	0207	Nylon Gtr1 C	0286	FatAcBs f NB	0365	Soft Alto B
0050	XPr.P*ff B R	0129	Dyno EP mf C	0208	Nylon Gtr2 A	0287	FatAcBs f NC	0366	Soft Alto C
0051	XPr.P*ff B M	0130	Wurly DI p A	0209	Nylon Gtr2 B	0288	Ac.Bass A	0367	Wide Sax A
0052	XPr.P*ff C L	0131	Wurly DI p B	0210	Nylon Gtr2 C	0289	Ac.Bass B	0368	Wide Sax B
0053	XPr.P*ff C R	0132	Wurly DI p C	0211	Bright Gtr A	0290	Ac.Bass C	0369	Wide Sax C
0054	XPr.P*ff C M	0133	Wurly DI f A	0212	Bright Gtr B	0291	Fng.EB1 mf A	0370	BreathySax A
0055	XPr.P mp A L	0134	Wurly DI f B	0213	Bright Gtr C	0292	Fng.EB1 mf B	0371	BreathySax B
0056	XPr.P mp A R	0135	Wurly DI f C	0214	Ac.Guitar1 A	0293	Fng.EB1 mf C	0372	BreathySax C
0057	XPr.P mp A M	0136	Wurly DI ff A	0215	Ac.Guitar1 B	0294	Fng.EB1 ff A	0373	TenorBreathy
0058	XPr.P mp B L	0137	Wurly DI ff B	0216	Ac.Guitar1 C	0295	Fng.EB1 ff B	0374	Tenor Sax A
0059	XPr.P mp B R	0138	Wurly DI ff C	0217	Ac.Gtr Hrm1A	0296	Fng.EB1 ff C	0375	Tenor Sax B
0060	XPr.P mp B M	0139	Soft SA EP A	0218	Ac.Gtr Hrm1B	0297	Fng.EB2 A	0376	Tenor Sax C
0061	XPr.P mp C L	0140	Soft SA EP B	0219	Ac.Gtr Hrm1C	0298	Fng.EB2 B	0377	Bari.Sax 1 A
0062	XPr.P mp C R	0141	Soft SA EP C	0220	Jazz Gtr A	0299	Fng.EB2 C	0378	Bari.Sax 1 B
0063	XPr.P mp C M	0142	Hard SA EP A	0221	Jazz Gtr B	0300	Finger Bs A	0379	Bari.Sax 1 C
0064	XPr.P ff A L	0143	Hard SA EP B	0222	Jazz Gtr C	0301	Finger Bs B	0380	Musette
0065	XPr.P ff A R	0144	Hard SA EP C	0223	Clean Gtr1 A	0302	Finger Bs C	0381	Harmonica A
0066	XPr.P ff A M	0145	SA E.Piano A	0224	Clean Gtr1 B	0303	P.Bass	0382	Harmonica B
0067	XPr.P ff B L	0146	SA E.Piano B	0225	Clean Gtr1 C	0304	Thumb MtBs A	0383	Harmonica C
0068	XPr.P ff B R	0147	SA E.Piano C	0226	Clr Mt Gtr A	0305	Thumb MtBs B	0384	Blues G-harp
0069	XPr.P ff B M	0148	80's E.Pno 1	0227	Clr Mt Gtr B	0306	Thumb MtBs C	0385	Flugel A
0070	XPr.P ff C L	0149	80's E.Pno 2	0228	Clr Mt Gtr C	0307	Fretlss Bs A	0386	Flugel B
0071	XPr.P ff C R	0150	80's E.Pno 3	0229	E.Gtr Ld	0308	Fretlss Bs B	0387	Flugel C
0072	XPr.P ff C M	0151	80's E.Pno 4	0230	Brt Strat1 A	0309	Fretlss Bs C	0388	Trumpet 1 A
0073	HM-Pno* A L	0152	Hard E.Pno	0231	Brt Strat1 B	0310	Fretlss SftA	0389	Trumpet 1 B
0074	HM-Pno* A R	0153	Celesta	0232	Brt Strat1 C	0311	Fretlss SftB	0390	Trumpet 1 C
0075	HM-Pno* A M	0154	Music Box	0233	FstPick70s1A	0312	Fretlss SftC	0391	Wide Tp A
0076	HM-Pno* B L	0155	ClavDB Brt A	0234	FstPick70s1B	0313	Pick EB 1 A	0392	Wide Tp B
0077	HM-Pno* B R	0156	ClavDB Brt B	0235	FstPick70s1C	0314	Pick EB 1 B	0393	Wide Tp C
0078	HM-Pno* B M	0157	ClavDB Brt C	0236	Funk Gtr A	0315	Pick EB 1 C	0394	Mute Tp A
0079	HM-Pno* C L	0158	Reg.Clav A	0237	Funk Gtr B	0316	Pick EB 2	0395	Mute Tp B

Waveform List

No.	Name	No.	Name	No.	Name	No.	Name	No.	Name
0396	Mute Tp C	0478	ChmbrStrRevB	0560	Church Bell	0642	Uuh Formant	0724	MG Zap 1
0397	Trombone 1 A	0479	ChmbrStrRevC	0561	Mild CanWave	0643	Metal Vox W1	0725	MG Zap 2
0398	Trombone 1 B	0480	Vls Pizz 1 A	0562	JD Crystal	0644	Metal Vox W2	0726	MG Zap 3
0399	Trombone 1 C	0481	Vls Pizz 1 B	0563	Bell Organ	0645	Metal Vox L	0727	MG Attack
0400	Trombone 2 A	0482	Vls Pizz 1 C	0564	Old DigiBell	0646	Metal Vox W3	0728	Syn Hrd Atk1
0401	Trombone 2 B	0483	VlsPizzRev A	0565	JD Bell Wave	0647	JD Rattles	0729	Syn Hrd Atk2
0402	Trombone 2 C	0484	VlsPizzRev B	0566	TinyBellWave	0648	Xylo Seq.	0730	Syn Swt Atk1
0403	Tuba A	0485	VlsPizzRev C	0567	Vib Wave	0649	JD Anklungs	0731	Syn Swt Atk2
0404	Tuba B	0486	Vcs Pizz 1 A	0568	JD Brt Digi	0650	JD Shami	0732	Syn Swt Atk3
0405	Tuba C	0487	Vcs Pizz 1 B	0569	Bagpipe	0651	SynBassClick	0733	Syn Swt Atk4
0406	Sft F.Horn A	0488	Vcs Pizz 1 C	0570	Digital Vox	0652	JD EP Atk	0734	SF Kick 1 L
0407	Sft F.Horn B	0489	UnisonSaw1 A	0571	JD WallyWave	0653	Key On Click	0735	SF Kick 1 R
0408	Sft F.Horn C	0490	UnisonSaw1 B	0572	JD Brusky Lp	0654	Org Click 1	0736	Reg.Kick L
0409	French Hrn A	0491	UnisonSaw1 C	0573	Bright Form	0655	Org Click 2	0737	Reg.Kick R
0410	French Hrn C	0492	Super Saw1 A	0574	JD Nasty	0656	JD Switch	0738	Jazz Kick
0411	XP Horn A	0493	Super Saw1 B	0575	JD Spark Vox	0657	JD Tuba Slap	0739	Jz Dry Kick
0412	XP Horn B	0494	Super Saw1 C	0576	JD Cutters	0658	TVF Trigger	0740	TR909 Kick 1
0413	F.HornSect A	0495	TranceSaw1 A	0577	SBF Hrd Ld	0659	Hi Q 1	0741	TR909 Kick 2
0414	F.HornSect B	0496	TranceSaw1 B	0578	JD EML 5th	0660	Slap 1	0742	AnalogKick 1
0415	F.HornSect C	0497	TranceSaw1 C	0579	Juno Saw HD	0661	Stick 1	0743	TR808 Kick
0416	Tp Section A	0498	Warm Pad A	0580	TB303 Saw HD	0662	Click	0744	SH32 Kick
0417	Tp Section B	0499	Warm Pad B	0581	Custm Saw HD	0663	Cutting Nz	0745	SF Snr L
0418	Tp Section C	0500	Warm Pad C	0582	MG Saw HD	0664	Ac.Bass Body	0746	SF Snr R
0419	OctBrass A L	0501	OB2 Pad 1 A	0583	Real MG Saw	0665	Flute Pad Nz	0747	SF Rim L
0420	OctBrass A R	0502	OB2 Pad 1 B	0584	DigitalSawHD	0666	Applause 1	0748	SF Rim R
0421	OctBrass B L	0503	OB2 Pad 1 C	0585	P5 Saw HD	0667	River	0749	Reg.Snr L
0422	OctBrass B R	0504	OB2 Pad 2 A	0586	Calc.Saw	0668	Thunder 1	0750	Reg.Snr R
0423	OctBrass C L	0505	OB2 Pad 2 B	0587	Calc.Saw inv	0669	Monsoon	0751	Reg.SnrGst L
0424	OctBrass C R	0506	OB2 Pad 2 C	0588	Synth Saw 1	0670	Stream	0752	Reg.SnrGst R
0425	XP Brass	0507	D-50 Heavn1A	0589	JD Syn Saw	0671	Bubble	0753	Sft Snr Gst
0426	OrchUnis A L	0508	D-50 Heavn1B	0590	JD Fat Saw	0672	Bird Song	0754	Jz Brsh Slap
0427	OrchUnis A R	0509	D-50 Heavn1C	0591	JP-8 Saw	0673	Dog Bark	0755	Jz Brsh Swsh
0428	OrchUnis1 BL	0510	SBF Vox A	0592	OB2 Saw HD	0674	Gallop	0756	Swish&Turn
0429	OrchUnis1 BR	0511	SBF Vox B	0593	700 Saw A	0675	Vint.Phone	0757	Concert SD 1
0430	OrchUnis1 CL	0512	SBF Vox C	0594	700 Saw B	0676	Office Phone	0758	Analog Snr 1
0431	OrchUnis1 CR	0513	Syn Vox 1 A	0595	700 Saw C	0677	Mobile Phone	0759	TR909 Snr 1
0432	Violin 1 A	0514	Syn Vox 1 B	0596	D-50 Saw	0678	Door Creak	0760	TR909 Snr 2
0433	Violin 1 B	0515	Syn Vox 1 C	0597	LA-Saw	0679	Door Slam	0761	TR808 Snr 1
0434	Violin 1 C	0516	Female Ahs A	0598	Air Wave	0680	Car Engine	0762	TR808 Snr 2
0435	Cello 1 A	0517	Female Ahs B	0599	GR-300 Saw	0681	Car Slip	0763	SF Crs Stk L
0436	Cello 1 B	0518	Female Ahs C	0600	Juno Sqr HD	0682	Car Pass	0764	SF Crs Stk R
0437	Cello 1 C	0519	Female Oos A	0601	P5 Sqr HD	0683	Crash Seq.	0765	Soft Stick
0438	VI Sect. A L	0520	Female Oos B	0602	Fat Square	0684	Gun Shot 1	0766	TR808 Rim
0439	VI Sect. A R	0521	Female Oos C	0603	JP-8 Square	0685	Siren	0767	LD L.Tom
0440	VI Sect.1 BL	0522	Male Aahs A	0604	SH-2 Square	0686	Train 1	0768	LD M.Tom
0441	VI Sect.1 BR	0523	Male Aahs B	0605	TB303 Sqr HD	0687	Airplane	0769	LD H.Tom
0442	VI Sect.1 CL	0524	Male Aahs C	0606	TB Dst Sqr A	0688	Helicopter 1	0770	RR F.Tom
0443	VI Sect.1 CR	0525	Jz Doos 1 A	0607	TB Dst Sqr B	0689	Space Voyage	0771	SF M.Tom
0444	Vc Sect.1 AL	0526	Jz Doos 1 B	0608	TB Dst Sqr C	0690	Blow Loop	0772	SF H.Tom
0445	Vc Sect.1 AR	0527	Jz Doos 1 C	0609	Dist SquareA	0691	Laugh	0773	Reg.F.Tom
0446	Vc Sect.1 BL	0528	JzDoos1 Lp A	0610	Dist SquareB	0692	Scream	0774	Reg.M.Tom
0447	Vc Sect.1 BR	0529	JzDoos1 Lp B	0611	Dist SquareC	0693	Punch	0775	Reg.H.Tom
0448	Vc Sect.1 CL	0530	JzDoos1 Lp C	0612	JP8 Pls 10HD	0694	Heartbeat	0776	TR808 Tom
0449	Vc Sect.1 CR	0531	Jz Doos 2 A	0613	JP8 Pls 15HD	0695	Footsteps	0777	Deep Tom
0450	Full Str A L	0532	Jz Doos 2 B	0614	JP8 Pls 25HD	0696	Machine Gun1	0778	Reg.CHH p
0451	Full Str A R	0533	Jz Doos 2 C	0615	JP8 Pls 30HD	0697	Laser	0779	Reg.CHH ff
0452	Full Str1 BL	0534	Jz Doos 2 Ip	0616	JP8 Pls 40HD	0698	Thunder Lp	0780	Reg.PHH mf
0453	Full Str1 BR	0535	JzVoiceDat A	0617	JP8 Pls 45HD	0699	Ac.Bass Nz	0781	Reg.PHH f
0454	Full Str1 CL	0536	JzVoiceDat B	0618	Syn Pulse 1	0700	E.Bass Nz 1	0782	Reg.OHH 1 mf
0455	Full Str1 CR	0537	JzVoiceDat C	0619	Syn Pulse 2	0701	E.Bass Nz 2	0783	Reg.OHH 1 ff
0456	JV Strings L	0538	Gospel Hum A	0620	700 Triangle	0702	E.Bass Slide	0784	TR808 CHH 1
0457	JV Strings R	0539	Gospel Hum B	0621	Syn Triangle	0703	Fng.EB Sld	0785	Noise CHH
0458	JV Strings A	0540	Gospel Hum C	0622	JD Triangle	0704	DistGtr Nz 1	0786	TR808 OHH 1
0459	JV Strings C	0541	Soprano Vox	0623	VS-Ramp	0705	DistGtr Nz 2	0787	TR606 OHH
0460	F.Str A L	0542	Kalimba 1	0624	Sync Sweep	0706	Gtr Fret Nz1	0788	Rock Crash 1
0461	F.Str A R	0543	JD Klmba Atk	0625	Sine	0707	Gtr Fret Nz2	0789	Splash Cym
0462	F.Str B L	0544	JD Wood Crak	0626	JD Fine Wine	0708	ClassicHseHt	0790	TR808 Cym
0463	F.Str B R	0545	JD Gamelan 1	0627	Digi Loop	0709	Narrow Hit	0791	Ride Cymbal
0464	F.Str C L	0546	JD Gamelan 2	0628	JD MetalWind	0710	Dist Hit	0792	Rock Rd Cup
0465	F.Str C R	0547	JD Log Drum	0629	Atmosphere	0711	Thin Beef	0793	Rock Rd Edge
0466	F.Str LpL	0548	JD Xylo	0630	DigiSpectrum	0712	Smear Hit	0794	China Cym 1
0467	F.Str LpR	0549	Marimba 1	0631	JD Vox Noise	0713	LoFi Min Hit	0795	Concert Cym 1
0468	F.StrStacA L	0550	Vibraphone 1	0632	SynVox Noise	0714	Orch. Hit	0796	Gospel Clap
0469	F.StrStacA R	0551	Glocken	0633	Shaku Noise	0715	Punch Hit	0797	TR808 Clap 1
0470	F.StrStacB L	0552	Steel Drums	0634	Digi Breath	0716	O'Skool Hit	0798	TR808 Clap 2
0471	F.StrStacB R	0553	D50 Bell A	0635	Agogo Noise	0717	Philly Hit	0799	Cowbell 1
0472	F.StrStacC L	0554	D50 Bell B	0636	White Noise	0718	Scratch 1	0800	TR808Cowbell
0473	F.StrStacC R	0555	D50 Bell C	0637	Pink Noise	0719	Scratch 2	0801	Wood Block1H
0474	ChmbrStrAt1A	0556	D50 Bell Lp	0638	Aah Formant	0720	Scratch 3	0802	Wood Block1L
0475	ChmbrStrAt1B	0557	Agogo Bell	0639	Eeh Formant	0721	Scratch 4	0803	Claves 1
0476	ChmbrStrAt1C	0558	Finger Bell	0640	lih Formant	0722	Scratch Push	0804	TR808 Claves
0477	ChmbrStrRevA	0559	Tubular Bell	0641	Ooh Formant	0723	Scratch Pull	0805	Castanet 1

No.	Name	No.	Name	No.	Name	No.	Name	No.	Name
0806	Whistle 1	0888	CivMTRs DB f	0970	Sitar 4 C	1052	Qu Di C	1134	TpRomntic vb
0807	Bongo High	0889	RtryOrg2 A L	0971	XV Sitar A	1053	QuDi 1 Vib A	1135	TrumpetShake
0808	Bongo Low	0890	RtryOrg2 A R	0972	XV Sitar C	1054	QuDi 1 Vib B	1136	Trombone 3 A
0809	Conga1 Hi Mt	0891	RtryOrg2 B L	0973	Sitar Gliss	1055	QuDi 1 Vib C	1137	Trombone 3 B
0810	Conga1 Slap	0892	RtryOrg2 B R	0974	Guzheng f	1056	QuDi 2 Vib A	1138	Trombone 3 C
0811	Conga1 Hi Op	0893	RtryOrg2 C L	0975	Guzheng Trem	1057	QuDi 2 Vib B	1139	Tbn mf A
0812	Conga1 LowOp	0894	RtryOrg2 C R	0976	Gu Zheng A	1058	QuDi 2 Vib C	1140	Tbn mf B
0813	TR808 Conga1	0895	E.Organ Slw	0977	Gu Zheng B	1059	Xiao 1 f	1141	Tbn mf C
0814	TR808 Conga2	0896	E.Organ Fst	0978	Gu Zheng C	1060	Xiao Trill	1142	Trombone 4
0815	Timbale High	0897	B3 1 FL A	0979	Santur 2 B	1061	Bawu f	1143	Tp Section2B
0816	Timbale Low	0898	B3 1 FL B	0980	Santur 2 C	1062	BawuVibFingr	1144	Tp Section2C
0817	Cabasa Cut 1	0899	B3 1 FL C	0981	Santur 3 A	1063	Bawu Trill	1145	Brass ff
0818	Maracas 1	0900	B3 2 FL A	0982	Santur 3 B	1064	Xun mp	1146	R&R Horns A
0819	808 Maracas1	0901	B3 2 FL B	0983	Santur 3 C	1065	Xun Orna	1147	R&R Horns B
0820	R8 Shaker	0902	B3 2 FL C	0984	Santur 4 A	1066	Hulusi 1 mf	1148	R&R Horns C
0821	Guiro Short	0903	B3 Perc 1 A	0985	Santur 4 B	1067	Sheng A	1149	PopBrsAtkA L
0822	Guiro Long	0904	B3 Perc 1 B	0986	Santur 4 C	1068	Sheng B	1150	PopBrsAtkA R
0823	Vibraslap 1	0905	B3 Perc 1 C	0987	Santur Trm A	1069	Sheng C	1151	PopBrsAtkB L
0824	Tambourine 1	0906	B3 3 A	0988	Santur Trm B	1070	Suona 1 A	1152	PopBrsAtkB R
0825	Cuica Mute	0907	B3 3 B	0989	Santur Trm C	1071	Suona 1 B	1153	PopBrsAtkC L
0826	Cuica Open	0908	B3 3 C	0990	HmrDulcimer	1072	Suona 1 C	1154	PopBrsAtkC R
0827	Timpani p	0909	B3 Perc 2 A	0991	Dulcimer A	1073	Suona 2 mf	1155	PopBrass A L
0828	Timpani f	0910	B3 Perc 2 B	0992	Dulcimer B	1074	Suona 2 ff	1156	PopBrass A R
0829	Timpani Roll	0911	B3 Perc 3 C	0993	Dulcimer C	1075	Suona 2 Grwl	1157	PopBrass B L
0830	Timpani Lp	0912	B3 1 Ch A	0994	Yangqin	1076	Zurna-A	1158	PopBrass B R
0831	ConcertBD p	0913	B3 1 Ch B	0995	Yangqin 1 mf	1077	F.AccordionA	1159	PopBrass C L
0832	ConcertBD f	0914	B3 1 Ch C	0996	Yangqin1Trem	1078	F.AccordionB	1160	PopBrass C R
0833	ConcertBD ff	0915	RockOrgan2 B	0997	Oygur f	1079	F.AccordionC	1161	OctBrs p A L
0834	ConcertBD Lp	0916	Power B fstA	0998	Oygur Trem	1080	D.AccordionA	1162	OctBrs p A R
0835	Triangle 1	0917	Power B fstB	0999	Upright Bs	1081	D.AccordionB	1163	OctBrs p B L
0836	JingleBell 1	0918	Power B fstC	1000	Fingerd Bs A	1082	D.AccordionC	1164	OctBrs p B R
0837	Wind Chime 1	0919	B3 Click	1001	Fingerd Bs B	1083	ACD Bltn R8	1165	OctBrs p C L
0838	Crotale	0920	Org Click 3	1002	Fingerd Bs C	1084	ACD Bltn R8s	1166	OctBrs p C R
0839	R8 Click	0921	Vint.Organ	1003	Fretless	1085	ACD Bltn R16	1167	Brass Fall L
0840	Metro Bell	0922	Pipe Organ 2	1004	Slap Bass	1086	ACD Bltn R4	1168	Brass Fall R
0841	Metro Click	0923	Nylon Gtr 3A	1005	SlapBs Wave1	1087	ACD Str R8	1169	Tps Fall
0842	DR202 Beep	0924	Nylon Gtr 3B	1006	SlapBs Wave2	1088	ACD Str Nz	1170	Brass Fall
0843	Low Sine	0925	Nylon Gtr 3C	1007	JUNO-60 Bass	1089	ACD Str R8s	1171	Violin 2 A
0844	DC	0926	RequintGt mf	1008	JP-4 Bass	1090	Accord 4' A	1172	Violin 2 B
0845	Reverse Cym1	0927	AcGtr Pick A	1009	SH-101 Bs	1091	Accord 4' B	1173	Strings L
0846	MC500 Beep 1	0928	AcGtr Pick B	1010	KG Poly Bs	1092	Accord 4' C	1174	Strings R
0847	MC500 Beep 2	0929	AcGtr Pick C	1011	Solid Bass	1093	Accord 8' A	1175	Marcato A L
0848	TB Dst Saw A	0930	Ac.Guitar2 A	1012	Mini Bs A	1094	Accord 8' B	1176	Marcato A R
0849	TB Dst Saw B	0931	Ac.Guitar2 B	1013	Mini Bs B	1095	Accord 8' C	1177	Marcato B L
0850	TB Dst Saw C	0932	Ac.Guitar2 C	1014	Mini Bs C	1096	Accord PadNz	1178	Marcato B R
0851	Ac Piano 1 B	0933	JC Strat Nz	1015	Flute Vib A	1097	Musette 1 A	1179	Marcato C L
0852	Ac Piano 1 C	0934	Strt Gtr	1016	Flute Vib B	1098	Musette 1 B	1180	Marcato C R
0853	Ac Piano2 pA	0935	FstPick70s	1017	Flute Vib C	1099	Musette 1 C	1181	OrcStrings A
0854	Ac Piano2 pB	0936	Clean TC pA	1018	Flute 2 B	1100	Musette 2 A	1182	OrcStrings B
0855	Ac Piano2 pC	0937	ClnGtr Mt Nz	1019	Flute 2 C	1101	Musette 2 B	1183	OrcStrings C
0856	Ac Piano2 fA	0938	PdlSteel A	1020	Atk Flute A	1102	Musette 2 C	1184	Erhu 1 Vib
0857	Ac Piano2 fB	0939	PdlSteel B	1021	Atk Flute B	1103	Musette 3 A	1185	Erhu 1 mp
0858	Ac Piano2 fC	0940	PdlSteel C	1022	Atk Flute C	1104	Musette 3 B	1186	Erhu 2 mp
0859	Piano Up TH	0941	Oud A	1023	BlwAltoVibPL	1105	Musette 3 C	1187	Erhu 2 f
0860	JD Piano 2 B	0942	Oud B	1024	BlwAltoVibPR	1106	Master A	1188	Er Hu 3 A
0861	JD Piano 2 C	0943	Oud C	1025	BlwAltoVibFL	1107	Master B	1189	Er Hu 3 B
0862	MKS Piano2 B	0944	Oud	1026	BlwAltoVibFR	1108	Master C	1190	Er Hu 3 C
0863	MKS Piano2 C	0945	Pipa mp 1	1027	Alto Sax Vib	1109	Single A	1191	Matouqin1 mp
0864	SA EP 1B	0946	Pipa mp 2	1028	Alto mp B	1110	Single B	1192	Matouqin1Vib
0865	SA EP 1C	0947	Pipa Trem	1029	Alto mp C	1111	Single C	1193	Matoqn Harm
0866	SA EP 2B	0948	Pipa Chord	1030	Blow Sax	1112	Bandoneon 1A	1194	MatoqnSldVib
0867	SA EP 2C	0949	Pi Pa A	1031	Blow Sax A	1113	Bandoneon 1B	1195	Keman L
0868	Dyn EP mp A	0950	Pi Pa B	1032	Blow Sax C	1114	Bandoneon 1C	1196	Keman R
0869	Dyn EP mp B	0951	Pi Pa C	1033	Blowed Sax	1115	Bandoneon 2A	1197	Blaster A
0870	Dyn EP mp C	0952	Chung Ruan A	1034	T.Sax hrd	1116	Bandoneon 2B	1198	Blaster B
0871	Wurly mp A	0953	Chung Ruan B	1035	T.Sax hrd A	1117	Bandoneon 2C	1199	Blaster C
0872	Wurly mp B	0954	Chung Ruan C	1036	T.Sax hrd B	1118	Bs/Musette 1	1200	UnisonSaw2 A
0873	Wurly mp C	0955	Dumbra mp	1037	T.Sax hrd C	1119	Bs/Musette 2	1201	UnisonSaw2 B
0874	Wurly mf A	0956	Dumbra Strum	1038	Blow Pipe	1120	Bs/Musette 3	1202	UnisonSaw2 C
0875	Wurly mf B	0957	UD	1039	Sicu 1	1121	Bs/Master	1203	Super Saw2 A
0876	Wurly mf C	0958	UD Body	1040	Sicu 2	1122	Bs/Single	1204	Super Saw2 B
0877	Wurly ff A	0959	Baglama L	1041	BottleBlow	1123	Bs/Bandneon1	1205	Super Saw2 C
0878	Wurly ff B	0960	Baglama H	1042	Shakuhachi 2	1124	Bs/Bandneon2	1206	TranceSaw2 A
0879	Wurly ff C	0961	Elk Baglama	1043	FolkClaVibFL	1125	Bandneon RHL	1207	TranceSaw2 B
0880	D-50 EP	0962	Kanun	1044	FolkClaVibFR	1126	Bandneon RHR	1208	TranceSaw2 C
0881	E.Piano 1 A	0963	Sitar/Drone	1045	FolkClaMarCL	1127	Bandneon Nz	1209	Fat JP-6
0882	E.Piano 1 B	0964	Sitar 2 A	1046	FolkClaMarCR	1128	Solo Tpt. A	1210	SBF Noise
0883	E.Piano 1 C	0965	Sitar 2 C	1047	Tr Klarnet	1129	Solo Tpt. B	1211	P5 Sink
0884	E.Piano 2 A	0966	Sitar 3 A	1048	Qudi mp 1	1130	Solo Tpt. C	1212	Synth Stack
0885	E.Piano 2 B	0967	Sitar 3 C	1049	Qudi Orna 1	1131	Trumpet 2 B	1213	Soft Pad B
0886	E.Piano 2 C	0968	Sitar 4 A	1050	Qu Di A	1132	Trumpet 2 C	1214	Soft Pad C
0887	EP Hard	0969	Sitar 4 B	1051	Qu Di B	1133	Tp_Mari Vb	1215	Syn Str

Waveform List

No.	Name	No.	Name	No.	Name	No.	Name	No.	Name
1216	JP Strings1A	1298	Angklung	1380	Br.Snr ff L	1462	Reg.CHH 1 p	1544	Claves 3
1217	JP Strings1B	1299	Bonang	1381	IronSnrFlm L	1463	Reg.CHH 1 mf	1545	Ban Gu 1
1218	JP Strings1C	1300	Pemade A	1382	WoodSnr mf L	1464	Reg.CHH 1 f	1546	Ban Gu 2
1219	JP StringsU2	1301	Pemade B	1383	WoodSnr ff L	1465	Reg.CHH 1 ff	1547	Castanet 2
1220	Syn Strings	1302	Pemade C	1384	Maple Lo Snr	1466	Reg.CHH 2 mf	1548	Whistle Long
1221	JP Hollo A	1303	DIGI Bell	1385	MapleSoft SN	1467	Reg.CHH 2 f	1549	Whistle Shrt
1222	JP Hollo B	1304	JP-8 Saw C	1386	PopSnr Gst 1	1468	Reg.CHH 2 ff	1550	ApitoHiShort
1223	JP Hollo C	1305	JP-6 Saw	1387	PopSnr Gst 2	1469	Reg.OHH 2 mf	1551	ApitoLoShort
1224	Hollo Wave	1306	P5 Saw 1 A	1388	PopSnr Gst 3	1470	Reg.OHH 2 f	1552	SambaWhistle
1225	Fantasynth A	1307	P5 Saw 2 A	1389	Jz Snare 1	1471	PopHHUPLo	1553	Whistle 2
1226	Fantasynth B	1308	P5 Saw 3 A	1390	Jz Snare 2	1472	PopHHUPMd	1554	ID Whistle 1
1227	Fantasynth C	1309	P5 Saw 3 B	1391	Jz Snare 3	1473	PopHHUPHi	1555	ID Whistle 2
1228	D-50 Heavn2A	1310	P5 Saw 3 C	1392	PopSnr Lo_L	1474	PopHHSideLo	1556	ID Whistle 3
1229	D-50 Heavn2B	1311	MG Saw	1393	PopSnr Md_L	1475	PopHHSideMd	1557	Shankh
1230	D-50 Heavn3A	1312	Saw	1394	PopSnr VH_L	1476	PopHHSideHi	1558	Bongo HM
1231	D-50 Heavn3B	1313	Synth Saw 2	1395	PopSnr Lo_R	1477	PopHHSideOp	1559	Bongo LM 1
1232	D-50 Heavn3C	1314	TB Dst Saw	1396	PopSnr Md_R	1478	PHHSdOpLg	1560	Bongo LM 2
1233	D50 Fantas 1	1315	Juno Saw+Sub	1397	PopSnr VH_R	1479	707 CHH	1561	Bongo Hi Hrd
1234	D50 Fantas 2	1316	MG Sqr HD	1398	PopSnr Ph	1480	Dixie HH Pdl	1562	Bongo HiOp f
1235	D50FuturePd1	1317	TB303 SqrFHD	1399	PopSnr ShRl	1481	Dixie HH Cls	1563	BongoHiSlap1
1236	D50FuturePd2	1318	TB Dst Sqr	1400	Fish Snare	1482	Dixie HH Hlf	1564	BongoHiSlap2
1237	D50 DNDance1	1319	TB Square	1401	Hybrid Snare	1483	Dixie HH Opn	1565	Bongo 1 Hi
1238	D50 DNDance2	1320	260 Sub OSC	1402	Cross Snare	1484	Crash Cym1 p	1566	Bongo 2 Hi
1239	D50 DNDance3	1321	V5-Triangle	1403	Rim Shot 1	1485	Crash Cym1 f	1567	Bongo 1 Lo
1240	D50 DNDance4	1322	ARP Sine HD	1404	Real Snare	1486	Crash Cym 2	1568	Bongo 2 Lo
1241	D50Pizzagogo	1323	JP-8 Pulse	1405	Std Snare	1487	Rock Crash 2	1569	Bongo Lo Hrd
1242	D50 StachVn	1324	MG Pulse A	1406	Sol Snare	1488	PopCrashLo	1570	Bongo Lo Sft
1243	D50NylInAtms1	1325	JP8 Pls 30	1407	Id Snare 1	1489	PopCrashMd	1571	Bongo LoOpmf
1244	D50NylInAtms2	1326	PWM Wave A	1408	Id Snare 2	1490	PopCrashHi	1572	Bongo LoOp f
1245	Syn Vox 2	1327	PWM Wave B	1409	Rock Snare	1491	RkCrash1Lo	1573	Bongo LoSlap
1246	Syn Vox 3 A	1328	PWM Wave C	1410	GS Fat SD	1492	RkCrash1Md	1574	Bongo slide
1247	Syn Vox 3 B	1329	PWM Wave	1411	Rim Shot 2	1493	RkCrash1Hi	1575	Conga 2H Op
1248	Syn Vox 3 C	1330	Lead Wave 1	1412	Rap Snare	1494	RkCrash2Lo	1576	Conga 2H Mt
1249	Vox Noise	1331	Lead Wave 2	1413	Dance Snare	1495	RkCrash2Md	1577	Conga 2H Slp
1250	Syn Vox 4	1332	Wire String	1414	TR909 Snr 3	1496	RkCrash2Hi	1578	Conga 2L Op
1251	MMM VOX	1333	Hard 5ths A	1415	IronSnrGst L	1497	China Cym 2	1579	Conga 2L Mt
1252	Choir Aah A	1334	Hard 5ths B	1416	Concert SD 2	1498	RkSplashLo	1580	Conga Mt Lo
1253	Choir Aah B	1335	Hard 5ths C	1417	Snare Roll	1499	RkSplashMd	1581	Conga Thumb
1254	Choir Aah C	1336	Cold Dress	1418	Cross Stick	1500	RkSplashHi	1582	Conga Link
1255	Choir Mmh A	1337	FX Bomb	1419	Br.SideStk L	1501	Splash	1583	Conga Roll
1256	Choir Mmh B	1338	FX Bell 1 fw	1420	WoodSideStkL	1502	PopRide BILo	1584	Conga HM
1257	Choir Mmh C	1339	FX Bell 2 fw	1421	707 Rim	1503	PopRide BIMd	1585	Conga 1H Mt
1258	Pop Voice	1340	Hi Q 2	1422	StudioLo Tom	1504	PopRide BIHi	1586	Conga M
1259	Voice Aahs A	1341	Slap 2	1423	StudioMidTom	1505	PopRideLo	1587	Conga 1L Mt
1260	Voice Aahs B	1342	Stick 2	1424	StudioHi Tom	1506	PopRideMd	1588	Conga LM
1261	Voice Aahs C	1343	Applause 2	1425	Jz Tom Lo	1507	PopRideHi	1589	Conga 1 Slap
1262	LargeChrF AL	1344	Applause 3	1426	Jz Tom Md 1	1508	RkRide1Lo	1590	Conga 1H Op
1263	LargeChrF AR	1345	Applause 4	1427	Jz Tom Md 2	1509	RkRide1Hi	1591	CongaLoOp f
1264	LargeChrF BL	1346	Sea	1428	Jz Tom Hi 1	1510	Concert Cym2	1592	CongaLoOp mf
1265	LargeChrF BR	1347	Thunder 2	1429	Jz Tom Hi 2	1511	808 Clps	1593	Timbales L
1266	LargeChrF CL	1348	Bird	1430	PopFrTmLoRC	1512	Hand Clap 1	1594	Timbales H
1267	LargeChrF CR	1349	Horse	1431	PopFrTmMdRC	1513	TR-909 HC	1595	Timbale 1
1268	Hey Brazil	1350	Gun Shot 2	1432	PopFrTmHiRC	1514	Hand Clap 2	1596	Timbale 2
1269	Sabor!	1351	Train 2	1433	Stdio T4 sft	1515	OR Clap 1	1597	Timbale 3 Lo
1270	Arriba!	1352	Helicopter 2	1434	Stdio T4 med	1516	OR Clap 2	1598	Timbale 3 Hi
1271	Ole!	1353	Machine Gun2	1435	Stdio T4 hrd	1517	FingerSnaps1	1599	Timbale 3 Sd
1272	Uno!	1354	Tao Hit	1436	Stdio T3 sft	1518	FingerSnaps2	1600	Timbles LoOp
1273	Dos!	1355	S Push	1437	Stdio T3 med	1519	Cowbell Lng	1601	Timbles LoMt
1274	Tres!	1356	S Pull	1438	Stdio T3 hrd	1520	Cowbell Edg	1602	Timbles HiOp
1275	Quatro!	1357	HM-Dummy	1439	Stdio T2 sft	1521	Cowbell mf	1603	Timbles HiMt
1276	Grito-Hahaha	1358	PopKickLo	1440	Stdio T2 med	1522	Cowbell f	1604	TimbalesHand
1277	Grito-Ahaha!	1359	PopKickMd	1441	Stdio T2 hrd	1523	Cowbell 2	1605	Timbales Rim
1278	Grito-Haahai	1360	PopKickHi	1442	Stdio T1 sft	1524	Cowbell 3	1606	TmbSideStck
1279	Grito-Rrrrr!	1361	Warm Kick p	1443	Stdio T1 med	1525	Cowbell 4	1607	TimbalesFil1
1280	Tiquittito!	1362	Warm Kick f	1444	Stdio T1 hrd	1526	Cowbell Op 1	1608	TimbalesFil2
1281	Grito-Oa Oa!	1363	Hush Kick p	1445	PopTom1LoRC	1527	Cowbell Mt 1	1609	TimbalesFil3
1282	Grito-Eh Eh!	1364	Hush Kick f	1446	PopTom1MdRC	1528	Cowbell Op 2	1610	TimbalesFil4
1283	Ama ya ahil!	1365	Jz Kick 1	1447	PopTom1HiRC	1529	Cowbell Mt 2	1611	SambaBateria
1284	Fuego!	1366	Jz Kick 2	1448	PopTom2LoRC	1530	BongoBell Op	1612	Cabasa Down1
1285	One	1367	Fat BD	1449	PopTom2MdRC	1531	BongoBell Mt	1613	Cabasa Down2
1286	Two	1368	Rom Kick	1450	PopTom2HiRC	1532	MamboBell Op	1614	Cabasa Up 1
1287	Three	1369	Techno BD1	1451	PopFrTmFILo	1533	MamboBell Mt	1615	Cabasa Up 2
1288	ZagrutaLoop	1370	909 CompKick	1452	PopFrTmFIMd	1534	Cowbell Low	1616	Real Cabasa1
1289	ZagrutaStop	1371	HipHop BD	1453	PopFrTmFIHi	1535	Cowbell Hi	1617	Real Cabasa2
1290	Vibes	1372	707 BD	1454	RkTom1Lo_Fl	1536	Cow Bell	1618	Cabasa
1291	Vibraphone 2	1373	TightSnr p L	1455	RkTom1Md_Fl	1537	808 Cows	1619	Cabasa Cut 2
1292	Glockenspiel	1374	TightSnr f L	1456	RkTom1Hi_Fl	1538	Wood Block2H	1620	Maracas 2
1293	Marimba Wave	1375	T.Snr Ghst L	1457	RkTom1VH_Fl	1539	Wood Block2L	1621	Maracas 3
1294	Marimba 2	1376	TightSnr ffl	1458	RkTom2Lo_Fl	1540	Wood Block 3	1622	Maracas3UpDw
1295	Kalimba 2	1377	T.Snr RS p L	1459	RkTom2Md_Fl	1541	Claves 2	1623	Shaker 1
1296	Balaphone 1	1378	Br.Snr p L	1460	RkTom2Hi_Fl	1542	Clave!	1624	Shaker 2
1297	Balaphone 2	1379	Br.Snr mf L	1461	RkTom2VH_Fl	1543	Claves Lo	1625	Shaker 3

No.	Name	No.	Name	No.	Name	No.	Name	No.	Name
1626	Shaker 4	1708	TablaBaya Te	1790	Surdo Open L	1872	C-Accord A3R	1954	ThumbMtBs fB
1627	Shaker Long	1709	Tabla Baya 4	1791	Surdo Open H	1873	C-Accord N1L	1955	ThumbMtBs fC
1628	Shaker Short	1710	Tbl Tak	1792	Surdo Mute 1	1874	C-Accord N1R	1956	DistTB Sqr
1629	Cabasa Roll	1711	Tbl Dom	1793	Surdo Rim 1	1875	C-Accord N2	1957	Oboe Mezzo A
1630	Caxixi	1712	Tabla Fx	1794	Surdo Hard	1876	E-Accord 1	1958	Oboe Mezzo B
1631	Ganza Soft	1713	Tbl Sak	1795	Surdo Open 1	1877	E-Accord 2	1959	Oboe Mezzo C
1632	Ganza Hard	1714	Tbl Rim	1796	Surdo Open 2	1878	BajoSxt mf	1960	Bari.Sax 2 A
1633	808 Maracas2	1715	Tbl NurRim	1797	Surdo Mute 2	1879	BajoSxt f	1961	Bari.Sax 2 B
1634	808 Maracas3	1716	Duff Dish	1798	Surdo Rim 2	1880	BajoSxtMute1	1962	Bari.Sax 2 C
1635	Chekere 1	1717	Duff T	1799	Surdo Soft	1881	BajoSxtMute2	1963	OctBrs f A L
1636	Chekere 2	1718	Ceng Ceng 1	1800	Caixa Open1	1882	CharangUp mf	1964	OctBrs f A R
1637	Chekere 3	1719	Udu Pot1 Hi	1801	Caixa Open2	1883	CharangUp f	1965	OctBrs f B L
1638	Guiro 2 Long	1720	Udu Pot1 Lo	1802	Caixa Roll	1884	ChrngOctUpmf	1966	OctBrs f B R
1639	Guiro 2 Shrt	1721	Udu Pot2 Lng	1803	Caixa Mute	1885	ChrngOctUp f	1967	OctBrs f C L
1640	Quide Long	1722	Udu Pot2 Sht	1804	Caixa Open3	1886	Guitarrn p	1968	OctBrs f C R
1641	Quide Short	1723	Udo Low	1805	Caixa Mute2	1887	Guitarrn mf	1969	OrchUnis2 BL
1642	Guiro 3 Long	1724	Udo Slap	1806	Caixa Roll 2	1888	MariTp Vb mf	1970	OrchUnis2 BR
1643	Guiro 3 Shrt	1725	Cajon	1807	Caixa Rim	1889	MariTp Vb f	1971	OrchUnis2 CL
1644	Long Guiro	1726	Cajon Lo	1808	RepiniqueHrd	1890	MariTpVbwAtk	1972	OrchUnis2 CR
1645	Short Guiro	1727	Cajon Hi	1809	RepiniqueSft	1891	MariTp Stc f	1973	Violin Vib A
1646	Guiro 4 Up	1728	Cajon Rol Hi	1810	Repinique1	1892	Banda Tp Vib	1974	Violin Vib B
1647	Guiro 4 Down	1729	Cajon Rol Lo	1811	Repinique2	1893	Banda Tp Stc	1975	Violin Vib C
1648	Guiro 4 Fast	1730	Cuica 1 Hi	1812	Repique Open	1894	Banda TbnVib	1976	Cello Vib A
1649	RecoRecoLng	1731	Cuica 1 Low	1813	Repique Rim	1895	Banda TbnStc	1977	Cello Vib B
1650	RecoRecoSht	1732	Cuica 2	1814	Repique Roll	1896	Banda Tuba	1978	Cello Vib C
1651	MtlGuiroLng	1733	Cuica Lo 1	1815	Timpani	1897	BandaTubaStc	1979	Cello 2 A
1652	MtlGuiroSht	1734	Cuica Lo 2	1816	Open Triangl	1898	Banda ClaVib	1980	Cello 2 B
1653	Vibraslap 2	1735	Cuica Hi 1	1817	Triangle 2	1899	Banda ClaStc	1981	Cello 2 C
1654	Vibraslap 3	1736	Cuica Hi 2	1818	Triangle 3	1900	CharangDw mf	1982	VI Sect.2 BL
1655	Quijada	1737	Mute Cuica	1819	Sagat Mid	1901	CharangDw f	1983	VI Sect.2 BR
1656	Rainstick	1738	Open Cuica	1820	Sagat Hi	1902	ChrngOctDwmf	1984	VI Sect.2 CL
1657	Tambarin 1	1739	Wadon 1	1821	Sagat Sak	1903	ChrngOctDw f	1985	VI Sect.2 CR
1658	Tambarin 2	1740	Wadon 2	1822	Sagat Open 1	1904	Ac.Pno p A L	1986	Vc Sect.2 BL
1659	Tambarin 3	1741	Wadon 3	1823	Sagat Close1	1905	Ac.Pno p A R	1987	Vc Sect.2 BR
1660	Tamborine p	1742	Wadon 4	1824	Twesat 1	1906	Ac.Pno p B L	1988	Vc Sect.2 CL
1661	Tamborine f	1743	Wadon 5	1825	Twesat Prc	1907	Ac.Pno p B R	1989	Vc Sect.2 CR
1662	PandeiroCrsh	1744	Wadon 6	1826	Twesat 2	1908	Ac.Pno p C L	1990	Full Str2 BL
1663	PandeiroHit	1745	Wadon 7	1827	Zil Open	1909	Ac.Pno p C R	1991	Full Str2 BR
1664	PandeiroMute	1746	Madal Da	1828	Zil Close	1910	Ac.Pno f A L	1992	Full Str2 CL
1665	PandeiroL Lo	1747	Madal Dun	1829	Clapstick	1911	Ac.Pno f A R	1993	Full Str2 CR
1666	PandeiroL Hi	1748	Madal Ta	1830	Agogo 1	1912	Ac.Pno f B L	1994	ChmbrStrAt2B
1667	PandeiroL Sp	1749	Dhol Beater	1831	Agogo 2 Lo	1913	Ac.Pno f B R	1995	ChmbrStrAt2C
1668	PandeiroL Rm	1750	Dhol Stick	1832	Agogo 2 Hi	1914	Ac.Pno f C L	1996	Vls Pizz 2 B
1669	PandeiroS Op	1751	Dhol Hand	1833	Agogo 3 Lo	1915	Ac.Pno f C R	1997	Vls Pizz 2 C
1670	PandeiroS Sp	1752	Dhol Body	1834	Agogo 3 Hi	1916	Dyno EP ff A	1998	Vcs Pizz 2 B
1671	PandeiroS Rm	1753	Dhol 1	1835	Asian Gong 1	1917	Dyno EP ff B	1999	Vcs Pizz 2 C
1672	PandeiroOpen	1754	Dhol 2	1836	GamelanGong1	1918	Dyno EP ff C	2000	OB2 Pad 3 B
1673	PandeiroRim	1755	Doholla Dom	1837	Wind Bell 1	1919	RtryOrg1 A L	2001	Jazz Doos A
1674	PandeiroRoll	1756	Doholla Sak	1838	Kane 1	1920	RtryOrg1 A R	2002	Jazz Doos B
1675	Tamborim Opn	1757	Doholla Tak	1839	JingleBell 2	1921	RtryOrg1 B L	2003	Jazz Doos C
1676	Tamborim Mut	1758	Dla Rim	1840	Wind Chime 2	1922	RtryOrg1 B R	2004	Jz Doos Lp A
1677	Tamborim Slp	1759	Dla Sak	1841	Sarna Bell	1923	RtryOrg1 C L	2005	Jz Doos Lp B
1678	TamborimOpen	1760	Dof 2 Dmo	1842	Berimbau Opn	1924	RtryOrg1 C R	2006	Jz Doos Lp C
1679	TamborimRim	1761	Dof 1 Rim	1843	Berimbau Up	1925	Nylon Gtr3 B	2007	JD Cowbell
1680	TamborimMute	1762	Dof 1 Dom	1844	Berimbau Dn	1926	Ac.Gtr ff A	2008	Vinyl Noise
1681	TamborimRoll	1763	Dof 1 Sak	1845	Berimbau Mut	1927	Ac.Gtr ff B	2009	Scratch 5
1682	Tambrin Hit	1764	Hager	1846	180:LatinPtn	1928	Ac.Gtr ff C	2010	MG Zap 4
1683	TambrinShake	1765	Zir	1847	160:CgMambo	1929	Ac.Gtr Sld A	2011	MG Zap 5
1684	Riq Open	1766	Nakrazn	1848	132:TmbI Ptn	1930	Ac.Gtr Sld B	2012	MG Zap 6
1685	Riq Mute	1767	Dholak 1	1849	104:Shakin'	1931	Ac.Gtr Sld C	2013	MG Zap 7
1686	Rek Open	1768	Dholak 2	1850	132:AgogoPtn	1932	Ac.Gtr Hrm2B	2014	MG Zap 8
1687	Rek Dom	1769	Dholak 3	1851	118:TablaBy1	1933	Clean Gtr2 B	2015	Syn Hrd Atk3
1688	Rek Tek	1770	Dholak 4	1852	118:TablaBy2	1934	Clean Gtr2 C	2016	Syn Mtl Atk1
1689	Rek BRS	1771	Dholak 5	1853	92:DholakPh1	1935	Brt Strat2 B	2017	Syn Mtl Atk2
1690	Rek ROL	1772	Dholak Ga	1854	92:DholakPh2	1936	Brt Strat2 C	2018	Syn Swt Atk5
1691	Rek KNA	1773	Dholak 6	1855	120:Dhol Ph	1937	FstPick70s2B	2019	Syn Swt Atk6
1692	Rek KNB	1774	Dholak 7	1856	SectChd 13th	1938	FstPick70s2C	2020	Syn Swt Atk7
1693	Doira Dun	1775	Dholak 8	1857	SectChd m9	1939	Overdrive2 C	2021	Reg.Kick p L
1694	Doira Tik	1776	Dholak Na	1858	SectChd Mj9	1940	Distortion2B	2022	Reg.Kick p R
1695	Tabla Baya 2	1777	Dholak Tun	1859	MC500 Beep 3	1941	Distortion2C	2023	Reg.Kick f L
1696	Tabla Baya 3	1778	Tabel H Dom	1860	Boing	1942	Banjo 2 B	2024	Reg.Kick f R
1697	TablaBaya Ka	1779	Tabel H Sak2	1861	G-Accord 1 L	1943	Sitar 5 B	2025	Rock Kick p
1698	TablaBaya Ge	1780	Tabel H Sak1	1862	G-Accord 1 R	1944	Sitar 5 C	2026	Rock Kick f
1699	Tabla Baya 1	1781	Tabel H Tac	1863	G-Accord 2 L	1945	E.Sitar 2 B	2027	Jazz Kick p
1700	TablaBayaSld	1782	Tabel L Dom	1864	G-Accord 2 R	1946	E.Sitar 2 C	2028	Jazz Kick mf
1701	Baya Sld	1783	Tabel L Sak1	1865	G-Accord 3 L	1947	FngrCmp Bs A	2029	Jazz Kick f
1702	Baya Long	1784	Tabel L Sak2	1866	G-Accord 3 R	1948	FngrCmp Bs B	2030	Dry Kick 1
1703	TablaBayaGin	1785	Tabel L Tac	1867	C-Accord A1L	1949	FngrCmp Bs C	2031	Tight Kick
1704	TablaBaya Na	1786	Merjaf Dom	1868	C-Accord A1R	1950	ThumbMtBs pA	2032	Old Kick
1705	TablaBayaTin	1787	Merjaf Tac	1869	C-Accord A2L	1951	ThumbMtBs pB	2033	Dry Kick 2
1706	TablaBayaTun	1788	Merjaf Sak	1870	C-Accord A2R	1952	ThumbMtBs pC	2034	Dry Kick 3
1707	TablaBaya Ti	1789	Surdo	1871	C-Accord A3L	1953	ThumbMtBs fA	2035	Power Kick

Waveform List

No.	Name	No.	Name	No.	Name	No.	Name	No.	Name
2036	R&B Kick L	2118	TR909 Ride	2200	Acid-Basson1f	2282	EEU-LTom2 f	2364	EM.Rek Trill
2037	Rk CmpKick L	2119	Hand Clap	2201	Acid-Basson2f	2283	EEU-LTom2 ff	2365	EM.Rek Tak 1
2038	Rk CmpKick R	2120	Bright Clap	2202	Acid-Basson2p	2284	EEU-MTom2 p	2366	EM.Rek Rim 1
2039	70's Kick	2121	Disc Clap	2203	Acid-Sop 1 p	2285	EEU-MTom2 f	2367	EM.Rek Rim 2
2040	Dance Kick	2122	TR909 Clap 1	2204	Acid-Sop 1 f	2286	EEU-MTom2 ff	2368	EM.Rek Brs 1
2041	HipHop Kick	2123	TR909 Clap 2	2205	Acid-Sop 2 p	2287	EEU-HTom2 p	2369	EM.Rek Brs 2
2042	Plastic Kick	2124	Cheap Clap	2206	Acid-Sop 2 f	2288	EEU-HTom2 f	2370	EM.Rek Tok
2043	AnalogKick 2	2125	Snap	2207	Acid-Violin p	2289	EEU-HTom2 ff	2371	EM.Rek Brs 3
2044	TR909 Kick 3	2126	Cowbell Mute	2208	Acid-Violin f	2290	EEU-CrsStk p	2372	EM.Rek Tak 2
2045	TR909 Kick 4	2127	Wood Block 4	2209	Acid-Clari1 p	2291	EEU-CrsStkmp	2373	EM.REK Sak
2046	TR707 Kick	2128	Bongo Hi Op	2210	Acid-Clari1 f	2292	EEU-CrsStkmp	2374	EM.Rek Tik
2047	TR909 Kick 5	2129	Bongo Lo Op	2211	Acid-Clari2 p	2293	EEU-CrsStk f	2375	EM.MazharDom
2048	Reg.SnrFlm L	2130	Conga2 Hi Mt	2212	Acid-Clari2 f	2294	EEUSplashCym	2376	EM.MazharTak
2049	Amb.Snr 1 p	2131	Conga2 HiSlp	2213	Acid-Musete p	2295	EEU-Ride mp	2377	EM.MazharSak
2050	Amb.Snr2 p L	2132	Conga2 Hi Op	2214	Acid-Musete f	2296	EEU-Ride mf	2378	EM.MazharBrs
2051	Amb.Snr2 p R	2133	Conga2 LowOp	2215	Acid-Accord p	2297	EEU-Ride Cup	2379	EM.Dofs Tak
2052	Maple Snr	2134	Timbale 4	2216	Acid-Accord f	2298	EEU-HH Op p	2380	EM.Dofs Dom
2053	Light Snr ff	2135	Cabasa Op 3	2217	Acid-Harmon p	2299	EEU-HH Op mp	2381	EM.Dofs Sak
2054	Snr Roll Lp	2136	Guiro 1	2218	Acid-Harmon f	2300	EEU-HH Op mf	2382	EM.Dofs Rim1
2055	Soft Jz Roll	2137	Tambourine 2	2219	Acid-Piccolo	2301	EEU-HH Op f	2383	EM.Dofs Rim2
2056	BrushRoll Lp	2138	Tambourine 3	2220	Acid-Oboe 1 p	2302	EEU-HH Cl1 p	2384	EM.Tbl2 Tak 1
2057	Dirty Snr	2139	Tambourine 4	2221	Acid-Oboe 1 f	2303	EEU-HH Cl1mp	2385	EM.Tbl2 Rim1
2058	Lo-Bit Snr	2140	Cuica 3	2222	Acid-Oboe 2 p	2304	EEU-HH Cl1mf	2386	EM.Tbl2 Dom
2059	Jngl pkt Snr	2141	Triangle 4	2223	Acid-Oboe 2 f	2305	EEU-HH Cl1 f	2387	SC.TR909 BD2
2060	Flange Snr	2142	Reverse Cym2	2224	Acid-Organ1 p	2306	EEU-HH Cl2 p	2388	EEU-BsDrm mf
2061	Analog Snr 2	2143	F.Str mp A L	2225	Acid-Organ1 f	2307	EEU-HH Cl2mp	2389	EEU-BsDrm f
2062	TR909 Snr 4	2144	F.Str mp A R	2226	Acid-Organ2 p	2308	EEU-HH Cl2mf	2390	EEU-BsDrm ff
2063	TR909 Snr 5	2145	Mrcr A L	2227	Acid-Organ2 f	2309	EEU-HH Cl2 f	2391	EEU-Snare1 p
2064	TR909 Snr 6	2146	Mrcr A R	2228	Acid-RegistS1	2310	EEU-ChnCym p	2392	EEU-Snare1mp
2065	Urbn Sn Roll	2147	RR F.Tom mp	2229	Acid-RegistS2	2311	EEU-ChnCym f	2393	EEU-Snare1mf
2066	Hard Stick	2148	RR F.Tom ff	2230	Acid-RegistS3	2312	EEU-Cr.Cym1p	2394	EEU-Snare1 f
2067	Dry Stick	2149	SF Kick 2 L	2231	Acid-KeyOff 1	2313	EEU-Cr.Cym1f	2395	EEU-Snare2mp
2068	R8 Comp Rim	2150	SF Kick 2 R	2232	Acid-KeyOff 2	2314	EEU-Cr.Cym2p	2396	EEU-Snare2mf
2069	TR909 Rim	2151	SF Snr p L	2233	EEU-PickBs1p	2315	EEU-Cr.Cym2f	2397	EEU-Snare2 f
2070	Reg.L.Tom p	2152	SF Snr p R	2234	EEU-PickBs1f	2316	EEUbnngL RM p	2398	EEU-Snare2ff
2071	Reg.L.Tom f	2153	SF Snr f L	2235	EEU-PickBs2p	2317	EEUbnngL RMmf	2399	EEU-ViolnS1
2072	Reg.M.Tom p	2154	SF Snr f R	2236	EEU-PickBs2f	2318	EEUbnngL RM f	2400	EEU-ViolnS2
2073	Reg.M.Tom f	2155	SF Snr ff L	2237	EEU-SlideBs1	2319	EEUbnngH RM p	2401	EEU-E.VlnS1
2074	Reg.H.Tom p	2156	SF Snr ff R	2238	EEU-SlideBs2	2320	EEUbnngH RMmp	2402	EEU-E.VlnS2
2075	Reg.H.Tom f	2157	SF Rim p L	2239	EEU-SlideBs3	2321	EEUbnngH RMmf		
2076	Reg.L.TomFlm	2158	SF Rim p R	2240	BB2-SlideBs1	2322	EEUbnngH RM f		
2077	Reg.M.TomFlm	2159	SF Rim mf L	2241	BB2-SlideBs2	2323	EEUbnngL OP p		
2078	Reg.H.TomFlm	2160	SF Rim mf R	2242	EEU-E.Gtr p	2324	EEUbnngL OPmp		
2079	Jazz Lo Tom	2161	SF Rim f L	2243	EEU-E.Gtr f	2325	EEUbnngL OP f		
2080	Jazz Mid Tom	2162	SF Rim f R	2244	EEU-E.GtrTrm	2326	EEUbnngL OPmf		
2081	Jazz Hi Tom	2163	SF SnrGst1 L	2245	EEU-BozkGlid	2327	EEUbnngH OP p		
2082	Jazz Lo Flm	2164	SF SnrGst1 R	2246	EEU-Bozuki p	2328	EEUbnngH OPmf		
2083	Jazz Mid Flm	2165	SF SnrGst2 L	2247	EEU-Bozuki f	2329	EEUbnngH OP f		
2084	Jazz Hi Flm	2166	SF SnrGst2 R	2248	EEU-Bozuk ff	2330	FG.TR909Clap		
2085	Dry Lo Tom	2167	R&B ShrtSnr1	2249	EEU-BozkTrem	2331	VA.Cha2Bell1		
2086	TR909 Tom	2168	Vint Snr	2250	EEU-Violin	2332	VA.Cha2Bell2		
2087	TR909 DstTom	2169	Short Snr	2251	EEU-E.Violin	2333	SC.Elec Kick		
2088	Rock CHH1 mf	2170	SF CStk p L	2252	EEU-Sax p	2334	EM.DholaRaka		
2089	Rock CHH1 f	2171	SF CStk p R	2253	EEU-Sax f	2335	EM.DholaTak1		
2090	Rock CHH2 mf	2172	SF L.Tom mf	2254	EEU-SaxKyOff	2336	EM.DholaTak2		
2091	Rock CHH2 f	2173	SF L.Tom ff	2255	EEU-Or.Sax p	2337	EM.DofDom 1		
2092	Rock OHH	2174	SF M.Tom mf	2256	EEU-Or.Sax f	2338	EM.DofDom 2		
2093	HipHop CHH	2175	SF M.Tom ff	2257	EEU-Clari p	2339	EM.DofDom 3		
2094	TR909 CHH 1	2176	SF H.Tom mf	2258	EEU-Clari f	2340	EM.DofTak 1		
2095	TR909 CHH 2	2177	SF H.Tom f	2259	EEU-ClakKyOff	2341	EM.DofSak 1		
2096	TR808 CHH 2	2178	RR FT Flm ff	2260	EEU-Gajde	2342	EM.DofSak 2		
2097	TR808 CHH 3	2179	SF LT Flm ff	2261	EEU-Tp p	2343	EM.DofSak 3		
2098	TR606 CHH	2180	SF MT Flm f	2262	EEU-Tp f	2344	EM.DofFingr2		
2099	TR606 DstCHH	2181	SF HT Flm p	2263	EEU-Tp Noise	2345	EM.Tbl Raka 1		
2100	Dance CHH	2182	SF HT Flm f	2264	EEU-Tapan Fx	2346	EM.Tbl Tak 1		
2101	TR909 PHH 1	2183	SF HT Flm ff	2265	EEU-TapanM p	2347	EM.Tbl Tik 1		
2102	TR909 PHH 2	2184	808 Kick 1 P	2266	EEU-TapanM f	2348	EM.Tbl Dom 1		
2103	TR808 PHH	2185	808 Kick 2 P	2267	EEU-TapanH p	2349	EM.Tbl Dom 2		
2104	TR606 PHH	2186	909 Kick 1 P	2268	EEU-TapanHmf	2350	EM.Tbl Sak 1		
2105	Lo-Bit OHH	2187	909 Kick 2 P	2269	EEU-TapanH f	2351	EM.Tbl Sak 2		
2106	HipHop OHH	2188	909 Kick 3 P	2270	EEU-TapanL p	2352	EM.Tbl Roll		
2107	TR909 OHH 1	2189	JungleKick P	2271	EEU-TapanL f	2353	EM.Tbl Tak 2		
2108	TR909 OHH 2	2190	808 Snr 1 P	2272	EEU-LTom1 p	2354	EM.Tbl Raka 2		
2109	TR808 OHH 2	2191	808 Snr 2 P	2273	EEU-LTom1 f	2355	EM.Tbl Rim 1		
2110	TR808 OHH 3	2192	909 Snr 1 P	2274	EEU-LTom1 ff	2356	EM.Tbl Toks1		
2111	Lite OHH	2193	909 Snr 2 P	2275	EEU-MTom1 p	2357	EM.Tbl Toks2		
2112	Rock Crash 3	2194	626 Snr P	2276	EEU-MTom1 f	2358	EM.Tbl Toks3		
2113	Jazz Crash	2195	106 Snr	2277	EEU-MTom1 ff	2359	EM.Tbl Toks4		
2114	TR909 Crash	2196	Jungle Snr P	2278	EEU-HTom1 p	2360	EM.Tbl Rim 2		
2115	Ride Bell	2197	Claptail	2279	EEU-HTom1 f	2361	EM.Tbl Tik 2		
2116	Jazz Ride p	2198	Dist Clap	2280	EEU-HTom1 ff	2362	EM.Rek Raka		
2117	Jazz Ride mf	2199	Acid-Basson1p	2281	EEU-LTom2 p	2363	EM.Rek Dom		

INTB

No.	Name	No.	Name	No.	Name
0001	GrandP* 1 mp	0080	Naggra 4 p	0159	Chenchen Opn
0002	GrandP* 1 f	0081	Naggra 4 mf	0160	Chenchen Cls
0003	GrandP* 1 ff	0082	Naggra 4 f	0161	Ceng Ceng 2
0004	GrandP* 2 mp	0083	Naggra 4 ff	0162	Kwaengwari f
0005	GrandP* 2 f	0084	Nggr Flam 1	0163	KwaengwariMt
0006	GrandP* 2 ff	0085	Nggr Flam 2	0164	Sagat Open 2
0007	GrandP*mp CL	0086	Nggr Flam 3	0165	Sagat Close2
0008	GrandP*mp CR	0087	Nggr Flam 4	0166	Asian Gong 2
0009	GrandP* f CL	0088	Nggr Mute p	0167	Shou Luo 1
0010	GrandP* f CR	0089	Nggr Mute mf	0168	Shou Luo 2
0011	GrandP*ff CL	0090	Nggr Mute f	0169	HuYinLuoH Op
0012	GrandP*ff CR	0091	Nggr Mute ff	0170	HuYinLuoL Op
0013	Erhu 4 mp	0092	Nggr Roll 1	0171	HuYinLuoH Mt
0014	Erhu 4 f	0093	Nggr Roll 2	0172	HuYinLuoL Mt
0015	Erhu 4 Vib	0094	Nggr Roll 3	0173	Big Gong
0016	Erhu 4 Harm	0095	Nggr Roll 4	0174	Kane 2
0017	Banhu mf	0096	Nggr Side p	0175	Kane Side
0018	Banhu Vib	0097	Nggr Side mf	0176	Kwaengwari p
0019	Banhu Harm	0098	Nggr Side f	0177	GamelanGong2
0020	Banhu Orna	0099	Nggr Side ff	0178	Saron
0021	Jinghu mf	0100	Dap 1 p	0179	Wind Bell 2
0022	Jinghu f	0101	Dap 1 f	0180	Jinghu Menu
0023	Sihu mp	0102	Dap 2 p	0181	Sihu Menu
0024	Sihu mf	0103	Dap 2 mf	0182	Matoqn Menu
0025	Sihu w/Atk	0104	Dap 2 f	0183	118:China Ph
0026	Sihu Harm	0105	Dap 2 ff	0184	132:China Ph
0027	Matouqin2 mp	0106	Dap 3		
0028	Matouqin2Vib	0107	Dap 4		
0029	Yangqin 2 mp	0108	Dap 5		
0030	Yangqin 2 mf	0109	Dap 6		
0031	Yangqin 2Hrd	0110	Dap 7		
0032	Yangqin2Trem	0111	Dap 8		
0033	Zhongruan mp	0112	Dap 9		
0034	Zhongruan mf	0113	Dap 10		
0035	Zhngruan Hrm	0114	Dap 11		
0036	ZhngruanStrm	0115	Dap 12		
0037	Guqin mp	0116	Dap 13		
0038	Guqin mf	0117	Dap 14		
0039	Guqin Harm	0118	Dap 15		
0040	Qudi 2 mp	0119	Dap 16		
0041	Qudi 2 f	0120	Dap Roll 1		
0042	Qudi 2 Orna	0121	Dap Roll 2		
0043	Xiao 2 f	0122	Dap Roll 3		
0044	Xiao2 Vib f	0123	Dap Roll 4		
0045	Hulusi 2 mf	0124	Dap Roll 5		
0046	Hulusi Atk	0125	Dap Roll 6		
0047	Gu Roll	0126	Dap Roll 7		
0048	Gu Hi	0127	Tabla 1		
0049	Changgo	0128	Tabla 2		
0050	Tang Gu Mt	0129	Tabla 3		
0051	Tang Gu Op	0130	Tabla 4		
0052	Shu Gu Rim	0131	Tabla 5		
0053	Shu Gu	0132	Tabla 6		
0054	Shu Ban	0133	Tabla 7		
0055	Dholak 9	0134	Tabla 8		
0056	Dholak 10	0135	Tabla 9		
0057	Dhol 3	0136	Tabla 10		
0058	Wadon 8	0137	Tabla 11		
0059	Wadon 9	0138	TablaRoll 1		
0060	Wadon 10	0139	TablaRoll 2		
0061	Wadon 11	0140	TablaRoll 3		
0062	Wadon 12	0141	TablaRoll 4		
0063	Wadon 13	0142	TablaRoll 5		
0064	Wadon 14	0143	TablaRoll 6		
0065	Wadaiko	0144	TablaRoll 7		
0066	Shimedaiko	0145	TablaRoll 8		
0067	Wadaiko Rim	0146	TablaRoll 9		
0068	Naggra 1 p	0147	Cga Mute Hi		
0069	Naggra 1 mf	0148	Cga Mute Lo		
0070	Naggra 1 f	0149	Mokugyo 1		
0071	Naggra 1 ff	0150	Mokugyo 2		
0072	Naggra 2 p	0151	Ban Gu 3		
0073	Naggra 2 mf	0152	Ban Gu 4		
0074	Naggra 2 f	0153	Ban Gu 5		
0075	Naggra 2 ff	0154	Ohkawa		
0076	Naggra 3 p	0155	Nao Bo		
0077	Naggra 3 mf	0156	Xiao Bo		
0078	Naggra 3 f	0157	Kopyak Mt		
0079	Naggra 3 ff	0158	Kopyak Op		

Patch List

Bank: DS

No.	Name	Sub-category	MSB	LSB	PC	
0001	Pf:S01	Grand Pno DS	PNO	087	073	001
0002	Pf:S02	Rock Pno DS	PNO	087	073	002
0003	Pf:S03	Nice Piano	PNO	087	073	003
0004	Pf:S04	WarmVoxPiano	PNO	087	073	004
0005	Pf:S05	MIDled Grand	PNO	087	073	005
0006	Pf:S06	West Coast	PNO	087	073	006
0007	Pf:S07	JV EP+	EP	087	073	007
0008	Pf:S08	80's FM	EP	087	073	008
0009	Pf:S09	Player's EP	EP	087	073	009
0010	Pf:S10	EP Mix	EP	087	073	010
0011	Pf:S11	Super Wurly	EP	087	073	011
0012	Ky:S01	Fantasia JV	BEL	087	073	012
0013	Ky:S02	D50 Fantasia	BEL	087	073	013
0014	Ky:S03	Wave Bells	BEL	087	073	014
0015	Ky:S04	Prefab Chime	BEL	087	073	015
0016	Ky:S05	Warm VibesLS	MLT	087	073	016
0017	Ky:S06	Acc.Master	ACD	087	073	017
0018	Ky:S07	Acd-Basson1	ACD	087	073	018
0019	Ky:S08	Acd-Clarint1	ACD	087	073	019
0020	Ky:S09	Acd-Harmonm	ACD	087	073	020
0021	Ky:S10	Acd-Musette	ACD	087	073	021
0022	Ky:S11	Acd-Oboe 1	ACD	087	073	022
0023	Ky:S12	Acd-Organ 1	ACD	087	073	023
0024	Ky:S13	Acd-Piccolo	ACD	087	073	024
0025	Ky:S14	Acd-Soprano 1	ACD	087	073	025
0026	Ky:S15	Acd-Violin	ACD	087	073	026
0027	Ky:S16	Acd-Accord	ACD	087	073	027
0028	Ky:S17	Acd-Basson2	ACD	087	073	028
0029	Ky:S18	Acd-Clarint2	ACD	087	073	029
0030	Ky:S19	Acd-Oboe 2	ACD	087	073	030
0031	Ky:S20	Acd-Organ 2	ACD	087	073	031
0032	Ky:S21	Acd-Soprano2	ACD	087	073	032
0033	Ky:S22	Acd-ResistS1	ACD	087	073	033
0034	Ky:S23	Acd-ResistS2	ACD	087	073	034
0035	Ky:S24	Acd-ResistS3	ACD	087	073	035
0036	Ky:S25	Perky Twin B	ORG	087	073	036
0037	Ky:S26	Perc OrganJU	ORG	087	073	037
0038	Ky:S27	Blues Perc	ORG	087	073	038
0039	Ky:S28	AllSkateSRX	ORG	087	073	039
0040	Ky:S29	D-50 Organ 1	ORG	087	073	040
0041	Ky:S30	D-50 Organ 2	ORG	087	073	041
0042	Ky:S31	ChurchOrg XP	ORG	087	073	042
0043	Gt:S01	Ac.Gtrs SRX	AGT	087	073	043
0044	Gt:S02	Bouzuki /Gld	AGT	087	073	044
0045	Gt:S03	Bouzuki Glid	AGT	087	073	045
0046	Gt:S04	Bouzuki /Trm	AGT	087	073	046
0047	Gt:S05	Bouzuki Trem	AGT	087	073	047
0048	Gt:S06	Bouzuki /3	AGT	087	073	048
0049	Gt:S07	E.Guitar/Trm	EGT	087	073	049
0050	Gt:S08	E.Guitar /2	EGT	087	073	050
0051	Gt:S09	E.Guitar 1	EGT	087	073	051
0052	Gt:S10	E.Guitar 2	EGT	087	073	052
0053	Gt:S11	E.Guitar Trm	EGT	087	073	053
0054	Gt:S12	Guitar Rock	DGT	087	073	054
0055	Gt:S13	Pick Bs DI	BS	087	073	055
0056	Gt:S14	Pick Bs Line	BS	087	073	056
0057	Gt:S15	Slap Bass JP	BS	087	073	057
0058	Gt:S16	GAIA A-1 Bs	SBS	087	073	058
0059	Gt:S17	Short Bs 1	SBS	087	073	059
0060	Gt:S18	Short Bs 2	SBS	087	073	060
0061	Gt:S19	5th Stac Bs	SBS	087	073	061
0062	Gt:S20	ElectroBass	SBS	087	073	062
0063	Gt:S21	SideChain Bs	SBS	087	073	063
0064	Gt:S22	Wobble Bass	SBS	087	073	064
0065	Gt:S23	WobbleBs/Mod	SBS	087	073	065
0066	Gt:S24	AutoWobble	SBS	087	073	066
0067	Gt:S25	Growl Bass	SBS	087	073	067
0068	Gt:S26	Monster Bass	SBS	087	073	068
0069	Gt:S27	E.Bs Slide 1	BS	087	073	069
0070	Gt:S28	E.Bs Slide 2	BS	087	073	070
0071	Gt:S29	E.Bs Slide 3	BS	087	073	071
0072	Gt:S30	E.Bs Slide 4	BS	087	073	072
0073	Gt:S31	E.Bs Slide 5	BS	087	073	073
0074	Oc:S01	Strings LS	STR	087	073	074
0075	Oc:S02	Stage Str LS	STR	087	073	075
0076	Oc:S03	St.Strings	STR	087	073	076
0077	Oc:S04	Strings	STR	087	073	077
0078	Oc:S05	FullStrings2	STR	087	073	078
0079	Oc:S06	Film Octaves	STR	087	073	079

No.	Name	Sub-category	MSB	LSB	PC	
0080	Oc:S07	GX Strings	STR	087	073	080
0081	Oc:S08	Slow Str XP	STR	087	073	081
0082	Oc:S09	Mood Strings	STR	087	073	082
0083	Oc:S10	Str+Choir	STR	087	073	083
0084	Oc:S11	JP8.Strings	STR	087	073	084
0085	Oc:S12	Violin 1	STR	087	073	085
0086	Oc:S13	Violin 2	STR	087	073	086
0087	Oc:S14	Vln Silde 1	STR	087	073	087
0088	Oc:S15	Vln Silde 2	STR	087	073	088
0089	Oc:S16	E.Violin 1	STR	087	073	089
0090	Oc:S17	E.Violin 2	STR	087	073	090
0091	Oc:S18	El Vln Sld 1	STR	087	073	091
0092	Oc:S19	El Vln Sld 2	STR	087	073	092
0093	Br:S01	X Brs Sect	BRS	087	073	093
0094	Br:S02	Brass RD	BRS	087	073	094
0095	Br:S03	R&R Brass	BRS	087	073	095
0096	Br:S04	SessionBrass	BRS	087	073	096
0097	Br:S05	Trumpet /2	BRS	087	073	097
0098	Br:S06	Trumpet /2wP	BRS	087	073	098
0099	Br:S07	TrumpetSftwP	BRS	087	073	099
0100	Br:S08	TrumpetLudwP	BRS	087	073	100
0101	Br:S09	Trumpet RD	BRS	087	073	101
0102	Br:S10	Trumpet	BRS	087	073	102
0103	Br:S11	Jump BrassFG	SBR	087	073	103
0104	Br:S12	JP8000 BrsFS	SBR	087	073	104
0105	Br:S13	Sax /2	SAX	087	073	105
0106	Br:S14	Sax /2 wPad	SAX	087	073	106
0107	Br:S15	Sax Sft wPad	SAX	087	073	107
0108	Br:S16	Sax Lud wPad	SAX	087	073	108
0109	Br:S17	Or Sax /2	SAX	087	073	109
0110	Br:S18	Or Sax/2wPad	SAX	087	073	110
0111	Br:S19	Alto mp	SAX	087	073	111
0112	Br:S20	Alto Sax LS	SAX	087	073	112
0113	Br:S21	Alto Sax GW	SAX	087	073	113
0114	Br:S22	BlowAltoVib	SAX	087	073	114
0115	Br:S23	Blow Tenor	SAX	087	073	115
0116	Br:S24	Solo Tenor	SAX	087	073	116
0117	Br:S25	Soft Sax	SAX	087	073	117
0118	Br:S26	Flute+1octLS	FLT	087	073	118
0119	Br:S27	Atk Flute	FLT	087	073	119
0120	Br:S28	SL LivingCal	FLT	087	073	120
0121	Br:S29	Clarinet /2	WND	087	073	121
0122	Sy:S01	Analog Lead	HLD	087	073	122
0123	Sy:S02	Synth Solo	HLD	087	073	123
0124	Sy:S03	JP8 PulseLd	HLD	087	073	124
0125	Sy:S04	EDM Saw Lead	HLD	087	073	125
0126	Sy:S05	EDM Sqr Lead	HLD	087	073	126
0127	Sy:S06	TB Dist Sqr	HLD	087	073	127
0128	Sy:S07	Trap Sqr Ld	HLD	087	073	128
0129	Sy:S08	P5 Sync Lead	HLD	087	074	001
0130	Sy:S09	RajasthaniLS	HLD	087	074	002
0131	Sy:S10	Edye Boost	HLD	087	074	003
0132	Sy:S11	Pure Sine Ld	SLD	087	074	004
0133	Sy:S12	Tri Stack Ld	SLD	087	074	005
0134	Sy:S13	D-50 Stack	SYN	087	074	006
0135	Sy:S14	Stacc.Heaven	SYN	087	074	007
0136	Sy:S15	D50 Stac Hvn	SYN	087	074	008
0137	Sy:S16	Pluck Synth	SYN	087	074	009
0138	Sy:S17	Solid Pluck	SYN	087	074	010
0139	Sy:S18	D50 DigiNDnc	SYN	087	074	011
0140	Sy:S19	D50 FuturePd	SYN	087	074	012
0141	Sy:S20	Sugar Keys	SYN	087	074	013
0142	Sy:S21	260 & JUNO	SYN	087	074	014
0143	Sy:S22	GAIA F-3Trns	SYN	087	074	015
0144	Sy:S23	S-SawStacSyn	SYN	087	074	016
0145	Sy:S24	SuperSaws	SYN	087	074	017
0146	Sy:S25	Bustranza JU	SYN	087	074	018
0147	Sy:S26	80s Poly	SYN	087	074	019
0148	Sy:S27	Fat Analog	SYN	087	074	020
0149	Sy:S28	Strobot 2	SYN	087	074	021
0150	Sy:S29	StepTrance 2	SYN	087	074	022
0151	Sy:S30	Growl Synth	SYN	087	074	023
0152	Sy:S31	Hover Lead	TEK	087	074	024
0153	Sy:S32	Tech Rave	TEK	087	074	025
0154	Sy:S33	Electrostrs2	TEK	087	074	026
0155	Sy:S34	SideChainPad	PLS	087	074	027
0156	Sy:S35	Blade Racer	PLS	087	074	028
0157	Sy:S36	Throbulax 2	PLS	087	074	029
0158	Sy:S37	Step In 2	PLS	087	074	030
0159	Sy:S38	Cross Talk 2	PLS	087	074	031
0160	Sy:S39	Chop Synth 2	PLS	087	074	032

No.	Name	Sub-category	MSB	LSB	PC	
0161	Sy:S41	AutoTrance 3	PLS	087	074	033
0162	Sy:S41	Poly Gate	PLS	087	074	034
0163	Sy:S42	Rise Up	FX	087	074	035
0164	Sy:S43	Sci-Fi FX x4	FX	087	074	036
0165	Sy:S44	LazerPoints2	FX	087	074	037
0166	Sy:S45	EDM Kick	FX	087	074	038
0167	Vo:S01	Chorus LS	VOX	087	074	039
0168	Vo:S02	Mmmms	VOX	087	074	040
0169	Vo:S03	Voc:Ensemble	VOX	087	074	041
0170	Vo:S04	Voc:5thStack	VOX	087	074	042
0171	Vo:S05	Voc:Robot	VOX	087	074	043
0172	Vo:S06	Voc:Saw	VOX	087	074	044
0173	Vo:S07	Voc:Sqr	VOX	087	074	045
0174	Vo:S08	Voc:Rise Up	VOX	087	074	046
0175	Vo:S09	Voc:Auto Vib	VOX	087	074	047
0176	Vo:S10	Voc:PitchEnv	VOX	087	074	048
0177	Vo:S11	Voc:Choir	VOX	087	074	049
0178	Vo:S12	Voc:Noise	VOX	087	074	050
0179	Vo:S13	SLSoundTrack	SPD	087	074	051
0180	Vo:S14	ORBit Pad	SPD	087	074	052
0181	Vo:S15	Soft Pad 2	SPD	087	074	053
0182	Vo:S16	Far East XP	SPD	087	074	054
0183	Vo:S17	JupiterMv JU	SPD	087	074	055
0184	Wr:S01	Gajde	ETH	087	074	056

Bank: PRST

No.	Name	Sub-category	MSB	LSB	PC	
0001	Pf:001	88StageGrand	PNO	087	064	001
0002	Pf:002	88StgGrand 2	PNO	087	064	002
0003	Pf:003	88StgGrand 3	PNO	087	064	003
0004	Pf:004	JUNO Piano 1	PNO	087	064	004
0005	Pf:005	JUNO Piano 2	PNO	087	064	005
0006	Pf:006	Rich Grand 1	PNO	087	064	006
0007	Pf:007	Rich Grand 2	PNO	087	064	007
0008	Pf:008	Piano+Str 1	PNO	087	064	008
0009	Pf:009	Fairy Piano	PNO	087	064	009
0010	Pf:010	Pop Piano 1	PNO	087	064	010
0011	Pf:011	Pop Piano 2	PNO	087	064	011
0012	Pf:012	ConcertGrand	PNO	087	064	012
0013	Pf:013	Warm Tune	PNO	087	064	013
0014	Pf:014	Hall Concert	PNO	087	064	014
0015	Pf:015	Mellow Tune	PNO	087	064	015
0016	Pf:016	Mono Piano 1	PNO	087	064	016
0017	Pf:017	Mono Piano 2	PNO	087	064	017
0018	Pf:018	Mono Piano 3	PNO	087	064	018
0019	Pf:019	Piano+Pad 1	PNO	087	064	019
0020	Pf:020	Piano+Pad 2	PNO	087	064	020
0021	Pf:021	Piano+Vox	PNO	087	064	021
0022	Pf:022	Piano+Str 2	PNO	087	064	022
0023	Pf:023	Layers	PNO	087	064	023
0024	Pf:024	Grand Hall	PNO	087	064	024
0025	Pf:025	Cicada Piano	PNO	087	064	025
0026	Pf:026	Rapsody	PNO	087	064	026
0027	Pf:027	Pop Piano 3	PNO	087	064	027
0028	Pf:028	Pop Piano 4	PNO	087	064	028
0029	Pf:029	Radio Piano	PNO	087	064	029
0030	Pf:030	Rokkin' pF	PNO	087	064	030
0031	Pf:031	JD Piano 1	PNO	087	064	031
0032	Pf:032	JD Piano 2	PNO	087	064	032
0033	Pf:033	JD Piano&Str	PNO	087	064	033
0034	Pf:034	SA Dance Pno	PNO	087	064	034
0035	Pf:035	E-Grand	PNO	087	064	035
0036	Pf:036	Back E-Grand	PNO	087	064	036
0037	Pf:037	Dark Grand	PNO	087	064	037
0038	Pf:038	Grand+FM	PNO	087	064	038
0039	Pf:039	Blend Piano	PNO	087	064	039
0040	Pf:040	Piano Oz	PNO	087	064	040
0041	Pf:041	Meditate Pno	PNO	087	064	041
0042	Pf:042	FX Piano	PNO	087	064	042
0043	Pf:043	AmbientPiano	PNO	087	064	043
0044	Pf:044	Pure EP	EP	087	064	044
0045	Pf:045	Pure EP Trem	EP	087	064	045
0046	Pf:046	Stage Phazer	EP	087	064	046
0047	Pf:047	SA EPiano 1	EP	087	064	047
0048	Pf:048	FM EP 1	EP	087	064	048
0049	Pf:049	Pure Wurly 1	EP	087	064	049
0050	Pf:050	Wurly Trem 1	EP	087	064	050
0051	Pf:051	VelSpdWurly	EP	087	064	051
0052	Pf:052	Phase EP 1	EP	087	064	052

No.	Name	Sub-category	MSB	LSB	PC	
0053	Pf:053	Phase Stg EP	EP	087	064	053
0054	Pf:054	Flanger EP	EP	087	064	054
0055	Pf:055	TEL Stage EP	EP	087	064	055
0056	Pf:056	Vintage EP 1	EP	087	064	056
0057	Pf:057	Vintage EP 2	EP	087	064	057
0058	Pf:058	Vintage EP 3	EP	087	064	058
0059	Pf:059	Stage EP 1	EP	087	064	059
0060	Pf:060	Stage EP 2	EP	087	064	060
0061	Pf:061	StageCabinet	EP	087	064	061
0062	Pf:062	StageEP Trem	EP	087	064	062
0063	Pf:063	EP Trem 1	EP	087	064	063
0064	Pf:064	EP Trem 2	EP	087	064	064
0065	Pf:065	EP Trem 3	EP	087	064	065
0066	Pf:066	EP Chorus 1	EP	087	064	066
0067	Pf:067	EP Chorus 2	EP	087	064	067
0068	Pf:068	EP Chorus 3	EP	087	064	068
0069	Pf:069	Phase EP 2	EP	087	064	069
0070	Pf:070	80s EP 1	EP	087	064	070
0071	Pf:071	Dyno EP	EP	087	064	071
0072	Pf:072	E.Piano	EP	087	064	072
0073	Pf:073	Back2the60s	EP	087	064	073
0074	Pf:074	Tine EP	EP	087	064	074
0075	Pf:075	LEO EP	EP	087	064	075
0076	Pf:076	SA EPiano 2	EP	087	064	076
0077	Pf:077	SA EP Trem	EP	087	064	077
0078	Pf:078	FM EP mix	EP	087	064	078
0079	Pf:079	FM-777	EP	087	064	079
0080	Pf:080	FM EP 2	EP	087	064	080
0081	Pf:081	FM EP 3	EP	087	064	081
0082	Pf:082	FM EP 4	EP	087	064	082
0083	Pf:083	Pure Wurly 2	EP	087	064	083
0084	Pf:084	Pure Wurly 3	EP	087	064	084
0085	Pf:085	Wurly Trem 2	EP	087	064	085
0086	Pf:086	Wurly Trem 3	EP	087	064	086
0087	Pf:087	EP Layer	EP	087	064	087
0088	Pf:088	80s EP 2	EP	087	064	088
0089	Pf:089	Pop EP	EP	087	064	089
0090	Pf:090	EP Bell 1	EP	087	064	090
0091	Pf:091	EP Bell 2	EP	087	064	091
0092	Pf:092	LonesomeRoad	EP	087	064	092
0093	Pf:093	Age'n'Tines	EP	087	064	093
0094	Pf:094	Brill TremEP	EP	087	064	094
0095	Pf:095	Crystal EP	EP	087	064	095
0096	Pf:096	Vintage Tine	EP	087	064	096
0097	Pf:097	Mk2 Stg phsr	EP	087	064	097
0098	Pf:098	Celestial EP	EP	087	064	098
0099	Pf:099	Psycho EP 1	EP	087	064	099
0100	Pf:100	Psycho EP 2	EP	087	064	100
0101	Pf:101	TineEP+Pad	EP	087	064	101
0102	Pf:102	Wurly+Pad	EP	087	064	102
0103	Pf:103	Dreaming EP	EP	087	064	103
0104	Pf:104	Balladeer	EP	087	064	104
0105	Pf:105	Remember	EP	087	064	105
0106	Pf:106	Vibe EP	EP	087	064	106
0107	Pf:107	sin(EP)	EP	087	064	107
0108	Pf:108	Fonky Fonky	EP	087	064	108
0109	Pf:109	FM EPad	EP	087	064	109
0110	Pf:110	EP Stack	EP	087	064	110
0111	Ky:001	HardRockORG1	ORG	087	064	111
0112	Ky:002	HardRockORG2	ORG	087	064	112
0113	Ky:003	GT Org Stack	ORG	087	064	113
0114	Ky:004	GT Org Std	ORG	087	064	114
0115	Ky:005	GT Org Clean	ORG	087	064	115
0116	Ky:006	Perc Organ 1	ORG	087	064	116
0117	Ky:007	FullStop Org	ORG	087	064	117
0118	Ky:008	FullDraw Org	ORG	087	064	118
0119	Ky:009	StakDraw Org	ORG	087	064	119
0120	Ky:010	JUNO PercOrg	ORG	087	064	120
0121	Ky:011	VKHold4Speed	ORG	087	064	121
0122	Ky:012	Pop Organ 1	ORG	087	064	122
0123	Ky:013	Pop Organ 2	ORG	087	064	123
0124	Ky:014	Pop Organ 3	ORG	087	064	124
0125	Ky:015	B Org 1	ORG	087	064	125
0126	Ky:016	B Org 2	ORG	087	064	126
0127	Ky:017	B Org 3	ORG	087	064	127
0128	Ky:018	B Org 4	ORG	087	064	128
0129	Ky:019	D.Bar Org 1	ORG	087	065	001
0130	Ky:020	D.Bar Org 2	ORG	087	065	002
0131	Ky:021	D.Bar Org 3	ORG	087	065	003
0132	Ky:022	D.Bar Org 4	ORG	087	065	004
0133	Ky:023	D.Bar Org 5	ORG	087	065	005

Patch List

No.	Name	Sub-category	MSB	LSB	PC	
0134	Ky:024	D.Bar Org 6	ORG	087	065	006
0135	Ky:025	D.Bar Org 7	ORG	087	065	007
0136	Ky:026	D.Bar Org 8	ORG	087	065	008
0137	Ky:027	Perc Organ 2	ORG	087	065	009
0138	Ky:028	X Perc Organ	ORG	087	065	010
0139	Ky:029	Rhythmi'n'B	ORG	087	065	011
0140	Ky:030	Phono Organ	ORG	087	065	012
0141	Ky:031	Rochno Org	ORG	087	065	013
0142	Ky:032	R&B Organ 1	ORG	087	065	014
0143	Ky:033	R&B Organ 2	ORG	087	065	015
0144	Ky:034	SuperDistOrg	ORG	087	065	016
0145	Ky:035	SuperDist Ld	ORG	087	065	017
0146	Ky:036	Dist Bee	ORG	087	065	018
0147	Ky:037	LoFi PercOrg	ORG	087	065	019
0148	Ky:038	60's Org 1	ORG	087	065	020
0149	Ky:039	60's Org 2	ORG	087	065	021
0150	Ky:040	Smoky Organ	ORG	087	065	022
0151	Ky:041	Soap Opera	ORG	087	065	023
0152	Ky:042	Crummy Organ	ORG	087	065	024
0153	Ky:043	Aqua Org/Pno	ORG	087	065	025
0154	Ky:044	Positive Org	ORG	087	065	026
0155	Ky:045	Chapel Organ	ORG	087	065	027
0156	Ky:046	Cathedral	ORG	087	065	028
0157	Ky:047	Grand Pipe	ORG	087	065	029
0158	Ky:048	Pipe Organ 1	ORG	087	065	030
0159	Ky:049	Pipe Organ 2	ORG	087	065	031
0160	Ky:050	Masked Opera	ORG	087	065	032
0161	Ky:051	Clavi 1	KEY	087	065	033
0162	Ky:052	Clavi 2	KEY	087	065	034
0163	Ky:053	Phase Clavi1	KEY	087	065	035
0164	Ky:054	Phase Clavi2	KEY	087	065	036
0165	Ky:055	AnalogClavi1	KEY	087	065	037
0166	Ky:056	Pulse Clavi	KEY	087	065	038
0167	Ky:057	VintageClavi	KEY	087	065	039
0168	Ky:058	Cutter Clavi	KEY	087	065	040
0169	Ky:059	Over-D6	KEY	087	065	041
0170	Ky:060	Cell Clavi	KEY	087	065	042
0171	Ky:061	Clavi 3	KEY	087	065	043
0172	Ky:062	Clavi 4	KEY	087	065	044
0173	Ky:063	Clavi 5	KEY	087	065	045
0174	Ky:064	Funky D	KEY	087	065	046
0175	Ky:065	Funky Line	KEY	087	065	047
0176	Ky:066	AnalogClavi2	KEY	087	065	048
0177	Ky:067	PWM Clavi	KEY	087	065	049
0178	Ky:068	Biting Clavi	KEY	087	065	050
0179	Ky:069	Reso Clavi	KEY	087	065	051
0180	Ky:070	BPF Clavi Ph	KEY	087	065	052
0181	Ky:071	Snappy Clavi	KEY	087	065	053
0182	Ky:072	Harpsy Clavi	KEY	087	065	054
0183	Ky:073	JUNO Harpsi	KEY	087	065	055
0184	Ky:074	Amadeus	KEY	087	065	056
0185	Ky:075	Music Bells	BEL	087	065	057
0186	Ky:076	D50Fantasia1	BEL	087	065	058
0187	Ky:077	D50Fantasia2	BEL	087	065	059
0188	Ky:078	Friends Bell	BEL	087	065	060
0189	Ky:079	FM Syn Bell	BEL	087	065	061
0190	Ky:080	Dreaming Box	BEL	087	065	062
0191	Ky:081	Himalaya Ice	BEL	087	065	063
0192	Ky:082	Wine Glass	BEL	087	065	064
0193	Ky:083	MuBox Pad	BEL	087	065	065
0194	Ky:084	Pop Bell	BEL	087	065	066
0195	Ky:085	Candy Bell	BEL	087	065	067
0196	Ky:086	FM Heaven	BEL	087	065	068
0197	Ky:087	JUNO Celesta	BEL	087	065	069
0198	Ky:088	Celesta Trem	BEL	087	065	070
0199	Ky:089	Glocken	BEL	087	065	071
0200	Ky:090	Music Box 1	BEL	087	065	072
0201	Ky:091	Music Box 2	BEL	087	065	073
0202	Ky:092	Kalimbells	BEL	087	065	074
0203	Ky:093	JUNO Bell	BEL	087	065	075
0204	Ky:094	Grained Bell	BEL	087	065	076
0205	Ky:095	Chime	BEL	087	065	077
0206	Ky:096	Bell Ring	BEL	087	065	078
0207	Ky:097	Tubular Bell	BEL	087	065	079
0208	Ky:098	5th Key	BEL	087	065	080
0209	Ky:099	Bell Monitor	BEL	087	065	081
0210	Ky:100	TubyRuesday	BEL	087	065	082
0211	Ky:101	Step Ice	BEL	087	065	083
0212	Ky:102	Vibe Trem 1	MLT	087	065	084
0213	Ky:103	Vibe Trem 2	MLT	087	065	085
0214	Ky:104	Pure Vibe	MLT	087	065	086

No.	Name	Sub-category	MSB	LSB	PC	
0215	Ky:105	Ringy Vibes	MLT	087	065	087
0216	Ky:106	Airie Vibez	MLT	087	065	088
0217	Ky:107	JUNO Marimba	MLT	087	065	089
0218	Ky:108	Soft Marimba	MLT	087	065	090
0219	Ky:109	FM Wood	MLT	087	065	091
0220	Ky:110	Xylo	MLT	087	065	092
0221	Ky:111	Ethno Keys	MLT	087	065	093
0222	Ky:112	Synergy MLT	MLT	087	065	094
0223	Ky:113	JUNO SteelDr	MLT	087	065	095
0224	Ky:114	50' SteelDrms	MLT	087	065	096
0225	Ky:115	Xylosizer	MLT	087	065	097
0226	Ky:116	AirPluck	MLT	087	065	098
0227	Ky:117	Toy Box	MLT	087	065	099
0228	Ky:118	Icy Keys	MLT	087	065	100
0229	Ky:119	Squeeze Me!	ACD	087	065	101
0230	Ky:120	Vodkakordion	ACD	087	065	102
0231	Ky:121	Guinguette	ACD	087	065	103
0232	Ky:122	JUNO Harm	HRM	087	065	104
0233	Ky:123	Blues harp	HRM	087	065	105
0234	Ky:124	Green Bullet	HRM	087	065	106
0235	Gt:001	JUNO Nylon	AGT	087	065	107
0236	Gt:002	Comp Stl Gtr	AGT	087	065	108
0237	Gt:003	Pre Mass Hum	AGT	087	065	109
0238	Gt:004	Uncle Martin	AGT	087	065	110
0239	Gt:005	12str Guitar	AGT	087	065	111
0240	Gt:006	Nylon Gtr	AGT	087	065	112
0241	Gt:007	SoftNylN Gtr	AGT	087	065	113
0242	Gt:008	Wet NylN Gtr	AGT	087	065	114
0243	Gt:009	Bright Nylon	AGT	087	065	115
0244	Gt:010	Pure Nylon	AGT	087	065	116
0245	Gt:011	Nylon Delay	AGT	087	065	117
0246	Gt:012	Thick Steel	AGT	087	065	118
0247	Gt:013	Wide Ac Gtr	AGT	087	065	119
0248	Gt:014	So good !	AGT	087	065	120
0249	Gt:015	Jazz Guitar1	EGT	087	065	121
0250	Gt:016	Jazz Guitar2	EGT	087	065	122
0251	Gt:017	DynoJazz Gtr	EGT	087	065	123
0252	Gt:018	Clean Gtr 1	EGT	087	065	124
0253	Gt:019	Clean Gtr 2	EGT	087	065	125
0254	Gt:020	Pick Gtr	EGT	087	065	126
0255	Gt:021	Strat Gtr 1	EGT	087	065	127
0256	Gt:022	Strat Gtr 2	EGT	087	065	128
0257	Gt:023	Funk Gtr	EGT	087	066	001
0258	Gt:024	StratSeq'nce	EGT	087	066	002
0259	Gt:025	Plug n' Gig1	EGT	087	066	003
0260	Gt:026	Plug n' Gig2	EGT	087	066	004
0261	Gt:027	Kinda Kurt	EGT	087	066	005
0262	Gt:028	Nice Oct Gtr	EGT	087	066	006
0263	Gt:029	Crimson Gtr	EGT	087	066	007
0264	Gt:030	Plugged!!	DGT	087	066	008
0265	Gt:031	Punker 1	DGT	087	066	009
0266	Gt:032	Rockin' Dly	DGT	087	066	010
0267	Gt:033	Loud Gtr	DGT	087	066	011
0268	Gt:034	Searing Gtr	DGT	087	066	012
0269	Gt:035	Searing COSM	DGT	087	066	013
0270	Gt:036	OctSearingGt	DGT	087	066	014
0271	Gt:037	Dist.Fingerz	DGT	087	066	015
0272	Gt:038	Fuzz Gtr	DGT	087	066	016
0273	Gt:039	Crunch Twin	DGT	087	066	017
0274	Gt:040	Larsen	DGT	087	066	018
0275	Gt:041	Trem-o-Vibe	DGT	087	066	019
0276	Gt:042	Touch Drive	DGT	087	066	020
0277	Gt:043	Chunk Atk	DGT	087	066	021
0278	Gt:044	LP Dist	DGT	087	066	022
0279	Gt:045	Hurling Gtr	DGT	087	066	023
0280	Gt:046	Power Chord	DGT	087	066	024
0281	Gt:047	Punker 2	DGT	087	066	025
0282	Gt:048	Ac Bass 1	BS	087	066	026
0283	Gt:049	Ac Bass 2	BS	087	066	027
0284	Gt:050	Ac Bass 3	BS	087	066	028
0285	Gt:051	Ulti Ac Bass	BS	087	066	029
0286	Gt:052	Downright Bs	BS	087	066	030
0287	Gt:053	Cmp'd Fng Bs	BS	087	066	031
0288	Gt:054	FingerMaster	BS	087	066	032
0289	Gt:055	Return2Base!	BS	087	066	033
0290	Gt:056	Finger Bs 1	BS	087	066	034
0291	Gt:057	Finger Bs 2	BS	087	066	035
0292	Gt:058	Finger Bs 3	BS	087	066	036
0293	Gt:059	Fretless Bs1	BS	087	066	037
0294	Gt:060	Fretless Bs2	BS	087	066	038
0295	Gt:061	Fretless Bs3	BS	087	066	039

No.	Name	Sub-category	MSB	LSB	PC
0296	Gt:062 RichFretless	BS	087	066	040
0297	Gt:063 NewAge Frtls	BS	087	066	041
0298	Gt:064 P-Bass	BS	087	066	042
0299	Gt:065 Roomy Bass	BS	087	066	043
0300	Gt:066 All Round Bs	BS	087	066	044
0301	Gt:067 Pick Bass 1	BS	087	066	045
0302	Gt:068 Pick Bass 2	BS	087	066	046
0303	Gt:069 Thumb Up!	BS	087	066	047
0304	Gt:070 Tubby Mute	BS	087	066	048
0305	Gt:071 Chicken Bass	BS	087	066	049
0306	Gt:072 Snug Bass	BS	087	066	050
0307	Gt:073 Chorus Bass	BS	087	066	051
0308	Gt:074 A Big Pick	BS	087	066	052
0309	Gt:075 Slap Bass	BS	087	066	053
0310	Gt:076 Slap w/Fx	BS	087	066	054
0311	Gt:077 Basement	BS	087	066	055
0312	Gt:078 Low Bass	SBS	087	066	056
0313	Gt:079 Foundation	SBS	087	066	057
0314	Gt:080 SH Sawtooth	SBS	087	066	058
0315	Gt:081 Fat RubberBs	SBS	087	066	059
0316	Gt:082 Garage Bass1	SBS	087	066	060
0317	Gt:083 Reso SynBs 1	SBS	087	066	061
0318	Gt:084 TB Dist Bs	SBS	087	066	062
0319	Gt:085 JUNO Acid Bs	SBS	087	066	063
0320	Gt:086 Monster Bass	SBS	087	066	064
0321	Gt:087 Oil Can Bass	SBS	087	066	065
0322	Gt:088 Pedal Syn Bs	SBS	087	066	066
0323	Gt:089 Big Mini 1	SBS	087	066	067
0324	Gt:090 Big Mini 2	SBS	087	066	068
0325	Gt:091 SH-2 Bs	SBS	087	066	069
0326	Gt:092 SH-101 Bs 1	SBS	087	066	070
0327	Gt:093 R&B Bass 1	SBS	087	066	071
0328	Gt:094 R&B Bass 2	SBS	087	066	072
0329	Gt:095 R&B Bass 3	SBS	087	066	073
0330	Gt:096 Moogy Bass 1	SBS	087	066	074
0331	Gt:097 Moogy Bass 2	SBS	087	066	075
0332	Gt:098 JUNO Reso	SBS	087	066	076
0333	Gt:099 Alpha SynBs1	SBS	087	066	077
0334	Gt:100 Alpha SynBs2	SBS	087	066	078
0335	Gt:101 SH Square	SBS	087	066	079
0336	Gt:102 Pedal Square	SBS	087	066	080
0337	Gt:103 Doze Bass 1	SBS	087	066	081
0338	Gt:104 VirtualRnBs1	SBS	087	066	082
0339	Gt:105 Saw&MG Bass1	SBS	087	066	083
0340	Gt:106 Square Bass	SBS	087	066	084
0341	Gt:107 Bs MG	SBS	087	066	085
0342	Gt:108 Bs Reso	SBS	087	066	086
0343	Gt:109 Bs SH	SBS	087	066	087
0344	Gt:110 Bs TB	SBS	087	066	088
0345	Gt:111 Bs MC	SBS	087	066	089
0346	Gt:112 Bs Pedal	SBS	087	066	090
0347	Gt:113 Bs Release	SBS	087	066	091
0348	Gt:114 Bs Cheeze	SBS	087	066	092
0349	Gt:115 Mini Like!	SBS	087	066	093
0350	Gt:116 MC-404 Bass	SBS	087	066	094
0351	Gt:117 Soft SynBass	SBS	087	066	095
0352	Gt:118 JUNO-106 Bs	SBS	087	066	096
0353	Gt:119 Smooth Bass	SBS	087	066	097
0354	Gt:120 Flat Bass	SBS	087	066	098
0355	Gt:121 Punch MG 2	SBS	087	066	099
0356	Gt:122 Electro Rubb	SBS	087	066	100
0357	Gt:123 R&B Bass 4	SBS	087	066	101
0358	Gt:124 Enorjizor	SBS	087	066	102
0359	Gt:125 LowFat Bass	SBS	087	066	103
0360	Gt:126 Doze Bass 2	SBS	087	066	104
0361	Gt:127 DCO Bass	SBS	087	066	105
0362	Gt:128 VirtualRnBs2	SBS	087	066	106
0363	Gt:129 Saw&MG Bass2	SBS	087	066	107
0364	Gt:130 MG+SubOsc Bs	SBS	087	066	108
0365	Gt:131 R&B Bass 5	SBS	087	066	109
0366	Gt:132 R&B Bass 6	SBS	087	066	110
0367	Gt:133 Not a Bass	SBS	087	066	111
0368	Gt:134 Reso SynBs 2	SBS	087	066	112
0369	Gt:135 SH-1 Bass	SBS	087	066	113
0370	Gt:136 SH-101 Bs 2	SBS	087	066	114
0371	Gt:137 Punch MG 1	SBS	087	066	115
0372	Gt:138 MKS-50 SynBs	SBS	087	066	116
0373	Gt:139 Gashed Bass	SBS	087	066	117
0374	Gt:140 Q Bass	SBS	087	066	118
0375	Gt:141 Super-G DX	SBS	087	066	119
0376	Gt:142 Kickin' Bass	SBS	087	066	120

No.	Name	Sub-category	MSB	LSB	PC
0377	Gt:143 OilDrum Bass	SBS	087	066	121
0378	Gt:144 Dust Bass	SBS	087	066	122
0379	Gt:145 Glide-iator	SBS	087	066	123
0380	Gt:146 Acid Punch	SBS	087	066	124
0381	Gt:147 Unison Bass	SBS	087	066	125
0382	Gt:148 Detune Bass	SBS	087	066	126
0383	Gt:149 Lo Bass	SBS	087	066	127
0384	Gt:150 Garage Bass2	SBS	087	066	128
0385	Gt:151 Sub Sonic	SBS	087	067	001
0386	Gt:152 Jungle Bass	SBS	087	067	002
0387	Gt:153 R&B Bass 7	SBS	087	067	003
0388	Gt:154 Simply Basic	SBS	087	067	004
0389	Gt:155 Beepin Bass	SBS	087	067	005
0390	Gt:156 MC-TB Bass	SBS	087	067	006
0391	Gt:157 Acdg Bass	SBS	087	067	007
0392	Gt:158 Loco Voco	SBS	087	067	008
0393	Gt:159 Unplug it!	SBS	087	067	009
0394	Gt:160 S&H Bass	SBS	087	067	010
0395	Gt:161 Destroyed Bs	SBS	087	067	011
0396	Gt:162 Lo-Fi TB	SBS	087	067	012
0397	Gt:163 Drop Bass	SBS	087	067	013
0398	Gt:164 Big Mini 3	SBS	087	067	014
0399	Gt:165 Muffled MG	SBS	087	067	015
0400	Gt:166 Intrusive Bs	SBS	087	067	016
0401	Gt:167 Alpha SynBs3	SBS	087	067	017
0402	Gt:168 TransistorBs	SBS	087	067	018
0403	Gt:169 JUNO-60 Bass	SBS	087	067	019
0404	Gt:170 Storm Bass	SBS	087	067	020
0405	Gt:171 Alpha ResoBs	SBS	087	067	021
0406	Gt:172 SH-101 Vibe	SBS	087	067	022
0407	Gt:173 Fazee Bass	SBS	087	067	023
0408	Gt:174 Hi-Energy Bs	SBS	087	067	024
0409	Gt:175 Low Nz Bass	SBS	087	067	025
0410	Oc:001 String Ens	STR	087	067	026
0411	Oc:002 JUNO Strings	STR	087	067	027
0412	Oc:003 Chamber Str1	STR	087	067	028
0413	Oc:004 Chamber Str2	STR	087	067	029
0414	Oc:005 Staccato	STR	087	067	030
0415	Oc:006 Pizzicato	STR	087	067	031
0416	Oc:007 Pizz/Stacc	STR	087	067	032
0417	Oc:008 Sahara Str	STR	087	067	033
0418	Oc:009 Random Mood	STR	087	067	034
0419	Oc:010 X Hall Str	STR	087	067	035
0420	Oc:011 DelayQuartet	STR	087	067	036
0421	Oc:012 Pop Str 1	STR	087	067	037
0422	Oc:013 Pop Str 2	STR	087	067	038
0423	Oc:014 Pop Str 3	STR	087	067	039
0424	Oc:015 WhiteStrings	STR	087	067	040
0425	Oc:016 JV Strings	STR	087	067	041
0426	Oc:017 Marcato	STR	087	067	042
0427	Oc:018 Strings 1	STR	087	067	043
0428	Oc:019 Strings 2	STR	087	067	044
0429	Oc:020 Stringz 101	STR	087	067	045
0430	Oc:021 Crossed Bows	STR	087	067	046
0431	Oc:022 Small Str	STR	087	067	047
0432	Oc:023 Warm Strings	STR	087	067	048
0433	Oc:024 DynaStrSect1	STR	087	067	049
0434	Oc:025 DynaStrSect2	STR	087	067	050
0435	Oc:026 Full Strings	STR	087	067	051
0436	Oc:027 X StrSection	STR	087	067	052
0437	Oc:028 Oct Strings	STR	087	067	053
0438	Oc:029 Strings 3	STR	087	067	054
0439	Oc:030 Monkey Str	STR	087	067	055
0440	Oc:031 Hybrid Str 1	STR	087	067	056
0441	Oc:032 Hybrid Str 2	STR	087	067	057
0442	Oc:033 Biggie Bows	STR	087	067	058
0443	Oc:034 Str Stacc mp	STR	087	067	059
0444	Oc:035 So Staccato	STR	087	067	060
0445	Oc:036 Long/Stacc	STR	087	067	061
0446	Oc:037 Pizz/Long	STR	087	067	062
0447	Oc:038 Vls PizzHall	STR	087	067	063
0448	Oc:039 DelicatePizz	STR	087	067	064
0449	Oc:040 Orch Pizz	STR	087	067	065
0450	Oc:041 BrightViolin	STR	087	067	066
0451	Oc:042 Bright Cello	STR	087	067	067
0452	Oc:043 Gang Strangs	STR	087	067	068
0453	Oc:044 Clustered!?!	STR	087	067	069
0454	Oc:045 Movie Scene	STR	087	067	070
0455	Oc:046 Mellow Tron	STR	087	067	071
0456	Oc:047 Tronic Str	STR	087	067	072
0457	Oc:048 Wind & Str 1	ORC	087	067	073

Patch List

No.	Name	Sub-category	MSB	LSB	PC	
0458	Oc:049	Wind & Str 2	ORC	087	067	074
0459	Oc:050	Farewell	ORC	087	067	075
0460	Oc:051	Orch & Horns	ORC	087	067	076
0461	Oc:052	Soft Orch 1	ORC	087	067	077
0462	Oc:053	Soft Orch 2	ORC	087	067	078
0463	Oc:054	Henry IX	ORC	087	067	079
0464	Oc:055	Ending Scene	ORC	087	067	080
0465	Oc:056	Symphonika	ORC	087	067	081
0466	Oc:057	Cheezy Movie	HIT	087	067	082
0467	Oc:058	Philly Hit	HIT	087	067	083
0468	Oc:059	Smear Hit 1	HIT	087	067	084
0469	Oc:060	Smear Hit 2	HIT	087	067	085
0470	Oc:061	Good Old Hit	HIT	087	067	086
0471	Oc:062	Mix Hit 1	HIT	087	067	087
0472	Oc:063	Mix Hit 2	HIT	087	067	088
0473	Oc:064	Lo-Fi Hit	HIT	087	067	089
0474	Oc:065	2ble Action	HIT	087	067	090
0475	Oc:066	In da Cave	HIT	087	067	091
0476	Oc:067	Housechord	HIT	087	067	092
0477	Oc:068	Mod Chord	HIT	087	067	093
0478	Oc:069	Dance Steam	HIT	087	067	094
0479	Br:001	Bright Brass	BRS	087	067	095
0480	Br:002	BreakOut Brs	BRS	087	067	096
0481	Br:003	StackTp Sect	BRS	087	067	097
0482	Br:004	Tb Section	BRS	087	067	098
0483	Br:005	TpTb Sect.	BRS	087	067	099
0484	Br:006	Brass Sect 1	BRS	087	067	100
0485	Br:007	Brass Sect 2	BRS	087	067	101
0486	Br:008	Brass & Sax	BRS	087	067	102
0487	Br:009	Simple Tutti	BRS	087	067	103
0488	Br:010	Tpts & Tmbs	BRS	087	067	104
0489	Br:011	BrassPartOut	BRS	087	067	105
0490	Br:012	Full sForza	BRS	087	067	106
0491	Br:013	Stereo Brass	BRS	087	067	107
0492	Br:014	F.Horns Sect	BRS	087	067	108
0493	Br:015	Solo Tp	BRS	087	067	109
0494	Br:016	Ambi Tp	BRS	087	067	110
0495	Br:017	Horn Chops	BRS	087	067	111
0496	Br:018	Mute Tp	BRS	087	067	112
0497	Br:019	Harmon Mute	BRS	087	067	113
0498	Br:020	Soft Tb	BRS	087	067	114
0499	Br:021	Solo Tb	BRS	087	067	115
0500	Br:022	Solo Bone	BRS	087	067	116
0501	Br:023	Flugel Horn	BRS	087	067	117
0502	Br:024	Spit Flugel	BRS	087	067	118
0503	Br:025	XP Horn	BRS	087	067	119
0504	Br:026	Grande Tuba	BRS	087	067	120
0505	Br:027	JUNO Tuba	BRS	087	067	121
0506	Br:028	80s Brass 1	SBR	087	067	122
0507	Br:029	Wide Syn Brs	SBR	087	067	123
0508	Br:030	Poly Brass	SBR	087	067	124
0509	Br:031	JP8000 Brass	SBR	087	067	125
0510	Br:032	JUNO Brass	SBR	087	067	126
0511	Br:033	DetuneSawBrs	SBR	087	067	127
0512	Br:034	J-Pop Brass	SBR	087	067	128
0513	Br:035	80s Brass 2	SBR	087	068	001
0514	Br:036	80s Brass 3	SBR	087	068	002
0515	Br:037	80s Brass 4	SBR	087	068	003
0516	Br:038	80s Brass 5	SBR	087	068	004
0517	Br:039	Ana Brass	SBR	087	068	005
0518	Br:040	Soft Brass	SBR	087	068	006
0519	Br:041	Ox Brass	SBR	087	068	007
0520	Br:042	Syn Brass 1	SBR	087	068	008
0521	Br:043	Syn Brass 2	SBR	087	068	009
0522	Br:044	Xpand Brass1	SBR	087	068	010
0523	Br:045	Xpand Brass2	SBR	087	068	011
0524	Br:046	Super Saw	SBR	087	068	012
0525	Br:047	SoftSynBrass	SBR	087	068	013
0526	Br:048	Windy Synth	SBR	087	068	014
0527	Br:049	Silky JP	SBR	087	068	015
0528	Br:050	Silk Brs Pad	SBR	087	068	016
0529	Br:051	X-Saw Brass	SBR	087	068	017
0530	Br:052	Cheesy Brass	SBR	087	068	018
0531	Br:053	Dual Saw Brs	SBR	087	068	019
0532	Br:054	JUNO-106 Brs	SBR	087	068	020
0533	Br:055	BreakOut Key	SBR	087	068	021
0534	Br:056	Stacked Brs	SBR	087	068	022
0535	Br:057	Sax Sect. 1	SAX	087	068	023
0536	Br:058	Sax Sect. 2	SAX	087	068	024
0537	Br:059	Horny Sax	SAX	087	068	025
0538	Br:060	JUNO Sop Sax	SAX	087	068	026

No.	Name	Sub-category	MSB	LSB	PC	
0539	Br:061	Solo Sop Sax	SAX	087	068	027
0540	Br:062	JUNO AltoSax	SAX	087	068	028
0541	Br:063	AltoLead Sax	SAX	087	068	029
0542	Br:064	FXM Alto Sax	SAX	087	068	030
0543	Br:065	XP TnrBrethy	SAX	087	068	031
0544	Br:066	JUNO Tnr Sax	SAX	087	068	032
0545	Br:067	Fat TenorSax	SAX	087	068	033
0546	Br:068	JUNO BariSax	SAX	087	068	034
0547	Br:069	JUNO Flute	FLT	087	068	035
0548	Br:070	JUNO Piccolo	FLT	087	068	036
0549	Br:071	Clarence.net	WND	087	068	037
0550	Br:072	JUNO Oboe	WND	087	068	038
0551	Br:073	JUNO E.Horn	WND	087	068	039
0552	Br:074	JUNO Bassoon	WND	087	068	040
0553	Br:075	Good Old Day	WND	087	068	041
0554	Br:076	WindWood	WND	087	068	042
0555	Sy:001	Porta Lead 1	HLD	087	068	043
0556	Sy:002	Porta Lead 2	HLD	087	068	044
0557	Sy:003	Solo Saw Ld	HLD	087	068	045
0558	Sy:004	Wind Syn Ld	HLD	087	068	046
0559	Sy:005	GR Lead 1	HLD	087	068	047
0560	Sy:006	Sync Lead	HLD	087	068	048
0561	Sy:007	JupiterLead1	HLD	087	068	049
0562	Sy:008	Alpha Spit 1	HLD	087	068	050
0563	Sy:009	Pro Fat Ld	HLD	087	068	051
0564	Sy:010	Saw Lead 1	HLD	087	068	052
0565	Sy:011	Saw Lead 2	HLD	087	068	053
0566	Sy:012	Saw Lead 3	HLD	087	068	054
0567	Sy:013	Saw Lead 4	HLD	087	068	055
0568	Sy:014	Saw Lead 5	HLD	087	068	056
0569	Sy:015	Saw Lead 6	HLD	087	068	057
0570	Sy:016	JUNO Lead	HLD	087	068	058
0571	Sy:017	Jump Poly	HLD	087	068	059
0572	Sy:018	Octa Juice	HLD	087	068	060
0573	Sy:019	Octa Saw	HLD	087	068	061
0574	Sy:020	Octa Sync 1	HLD	087	068	062
0575	Sy:021	Octa Sync 2	HLD	087	068	063
0576	Sy:022	Hot Sync	HLD	087	068	064
0577	Sy:023	Hot Coffee	HLD	087	068	065
0578	Sy:024	Phase Lead	HLD	087	068	066
0579	Sy:025	Waspy Lead 1	HLD	087	068	067
0580	Sy:026	Follow Me 1	HLD	087	068	068
0581	Sy:027	Follow Me 2	HLD	087	068	069
0582	Sy:028	Classic Ld 1	HLD	087	068	070
0583	Sy:029	Classic Ld 2	HLD	087	068	071
0584	Sy:030	Digi Lead 1	HLD	087	068	072
0585	Sy:031	Digi Lead 2	HLD	087	068	073
0586	Sy:032	DC Triangle	HLD	087	068	074
0587	Sy:033	Sqr-Seqence	HLD	087	068	075
0588	Sy:034	Pure Square	HLD	087	068	076
0589	Sy:035	Griggley	HLD	087	068	077
0590	Sy:036	Legato Saw	HLD	087	068	078
0591	Sy:037	Dual Profs	HLD	087	068	079
0592	Sy:038	Gwyo Press	HLD	087	068	080
0593	Sy:039	Q DualSaws	HLD	087	068	081
0594	Sy:040	Mogulator Ld	HLD	087	068	082
0595	Sy:041	DirtyVoltage	HLD	087	068	083
0596	Sy:042	Clean?	HLD	087	068	084
0597	Sy:043	Distortion	HLD	087	068	085
0598	Sy:044	Syn Lead 1	HLD	087	068	086
0599	Sy:045	Syn Lead 2	HLD	087	068	087
0600	Sy:046	X-Sink Delay	HLD	087	068	088
0601	Sy:047	Destroyed Ld	HLD	087	068	089
0602	Sy:048	Synchro Lead	HLD	087	068	090
0603	Sy:049	Sync Tank	HLD	087	068	091
0604	Sy:050	Sync Ld Mono	HLD	087	068	092
0605	Sy:051	SyncModulate	HLD	087	068	093
0606	Sy:052	2krazy Brite	HLD	087	068	094
0607	Sy:053	Distorted MG	HLD	087	068	095
0608	Sy:054	Dist Lead	HLD	087	068	096
0609	Sy:055	Ringmod Lead	HLD	087	068	097
0610	Sy:056	BodyElectric	HLD	087	068	098
0611	Sy:057	SonicVampire	HLD	087	068	099
0612	Sy:058	Stimulation	HLD	087	068	100
0613	Sy:059	Wire Sync	HLD	087	068	101
0614	Sy:060	Epic Lead	HLD	087	068	102
0615	Sy:061	Bag Lead	HLD	087	068	103
0616	Sy:062	Wezcoast	HLD	087	068	104
0617	Sy:063	HyperJupiter	HLD	087	068	105
0618	Sy:064	Vintagolizer	HLD	087	068	106
0619	Sy:065	C64 Lead	HLD	087	068	107

No.	Name	Sub-category	MSB	LSB	PC	
0620	Sy:066	303 NRG	HLD	087	068	108
0621	Sy:067	Feat Lead	HLD	087	068	109
0622	Sy:068	Cell SquLead	SLD	087	068	110
0623	Sy:069	Theramax 1	SLD	087	068	111
0624	Sy:070	Pulse Lead 1	SLD	087	068	112
0625	Sy:071	Pulse Lead 2	SLD	087	068	113
0626	Sy:072	Mid Saw Ld	SLD	087	068	114
0627	Sy:073	On Air	SLD	087	068	115
0628	Sy:074	Tri Lead 1	SLD	087	068	116
0629	Sy:075	Tri Lead 2	SLD	087	068	117
0630	Sy:076	Sine Lead 1	SLD	087	068	118
0631	Sy:077	Sine Lead 2	SLD	087	068	119
0632	Sy:078	Sqr Lead 1	SLD	087	068	120
0633	Sy:079	Sqr Lead 2	SLD	087	068	121
0634	Sy:080	SH Sqr Lead	SLD	087	068	122
0635	Sy:081	Sinetific	SLD	087	068	123
0636	Sy:082	JUNO Soft Ld	SLD	087	068	124
0637	Sy:083	Spooky Lead	SLD	087	068	125
0638	Sy:084	PeakArpSine	SLD	087	068	126
0639	Sy:085	Howards Lead	SLD	087	068	127
0640	Sy:086	SoloNzPeaker	SLD	087	068	128
0641	Sy:087	R&B Tri Ld 1	SLD	087	069	001
0642	Sy:088	R&B Tri Ld 2	SLD	087	069	002
0643	Sy:089	JupiterLead2	SLD	087	069	003
0644	Sy:090	JupiterLead3	SLD	087	069	004
0645	Sy:091	Dig-n-Duke	SLD	087	069	005
0646	Sy:092	Sqr Diamond	SLD	087	069	006
0647	Sy:093	Soft Lead	SLD	087	069	007
0648	Sy:094	Soft Saw Ld	SLD	087	069	008
0649	Sy:095	X-Pulse Lead	SLD	087	069	009
0650	Sy:096	Mild 2-SawLd	SLD	087	069	010
0651	Sy:097	Mew Lead	SLD	087	069	011
0652	Sy:098	Shy Soloist	SLD	087	069	012
0653	Sy:099	Theramax 2	SLD	087	069	013
0654	Sy:100	Therasqu	SLD	087	069	014
0655	Sy:101	GR Lead 2	SLD	087	069	015
0656	Sy:102	SH-2 Lead	SLD	087	069	016
0657	Sy:103	Jucy Saw	SLD	087	069	017
0658	Sy:104	Reso Lead	SLD	087	069	018
0659	Sy:105	Modulated Ld	SLD	087	069	019
0660	Sy:106	Synthi Fizz	SLD	087	069	020
0661	Sy:107	Waspy Lead 2	SLD	087	069	021
0662	Sy:108	Pulstar Ld	SLD	087	069	022
0663	Sy:109	Naked Lead	SLD	087	069	023
0664	Sy:110	Alpha Spit 2	SLD	087	069	024
0665	Sy:111	JP Saw Lead	SLD	087	069	025
0666	Sy:112	Violin Lead	SLD	087	069	026
0667	Sy:113	Mod Lead	SLD	087	069	027
0668	Sy:114	Tristar	SLD	087	069	028
0669	Sy:115	Chubby Lead	SLD	087	069	029
0670	Sy:116	Sneaky Leady	SLD	087	069	030
0671	Sy:117	Shaku Lead	SLD	087	069	031
0672	Sy:118	Legato Tkno	SLD	087	069	032
0673	Sy:119	Reso Saw Ld	SLD	087	069	033
0674	Sy:120	SliCed Lead	SLD	087	069	034
0675	Sy:121	Mini Growl	SLD	087	069	035
0676	Sy:122	Evangelized	SLD	087	069	036
0677	Sy:123	Air Lead	SLD	087	069	037
0678	Sy:124	Stacc Heaven	SYN	087	069	038
0679	Sy:125	Sugar Synth	SYN	087	069	039
0680	Sy:126	Synth Key	SYN	087	069	040
0681	Sy:127	Frontier Syn	SYN	087	069	041
0682	Sy:128	Summer Str	SYN	087	069	042
0683	Sy:129	JUNO Poly	SYN	087	069	043
0684	Sy:130	SuperSawSlow	SYN	087	069	044
0685	Sy:131	Cue Tip	SYN	087	069	045
0686	Sy:132	Waspy Synth	SYN	087	069	046
0687	Sy:133	Europe Xpres	SYN	087	069	047
0688	Sy:134	Squeeepy	SYN	087	069	048
0689	Sy:135	DOC Stack	SYN	087	069	049
0690	Sy:136	Sweep Lead	SYN	087	069	050
0691	Sy:137	80s Saws 1	SYN	087	069	051
0692	Sy:138	80s Saws 2	SYN	087	069	052
0693	Sy:139	80s Saws 3	SYN	087	069	053
0694	Sy:140	Digitalless	SYN	087	069	054
0695	Sy:141	Flip Pad	SYN	087	069	055
0696	Sy:142	Short Detune	SYN	087	069	056
0697	Sy:143	forSequence	SYN	087	069	057
0698	Sy:144	Memory Pluck	SYN	087	069	058
0699	Sy:145	Metalic Bass	SYN	087	069	059
0700	Sy:146	Aqua	SYN	087	069	060

No.	Name	Sub-category	MSB	LSB	PC	
0701	Sy:147	Round SQR	SYN	087	069	061
0702	Sy:148	Big Planet	SYN	087	069	062
0703	Sy:149	Wet Atax	SYN	087	069	063
0704	Sy:150	Houze Clavi	SYN	087	069	064
0705	Sy:151	Saw Stack	SYN	087	069	065
0706	Sy:152	Frgile Saws	SYN	087	069	066
0707	Sy:153	Steamed Sawz	SYN	087	069	067
0708	Sy:154	RAVtune	SYN	087	069	068
0709	Sy:155	Bustranza	SYN	087	069	069
0710	Sy:156	Digi Saw Syn	SYN	087	069	070
0711	Sy:157	JP OctAttack	SYN	087	069	071
0712	Sy:158	Oct Unison	SYN	087	069	072
0713	Sy:159	Xtatic	SYN	087	069	073
0714	Sy:160	Dirty Combo	SYN	087	069	074
0715	Sy:161	FM's Attack	SYN	087	069	075
0716	Sy:162	Digi-vox Syn	SYN	087	069	076
0717	Sy:163	Fairy Factor	SYN	087	069	077
0718	Sy:164	Tempest	SYN	087	069	078
0719	Sy:165	X-Racer	SYN	087	069	079
0720	Sy:166	TB Booster	SYN	087	069	080
0721	Sy:167	Syn-Orch/Mod	SYN	087	069	081
0722	Sy:168	Pressyn	SYN	087	069	082
0723	Sy:169	High Five	SYN	087	069	083
0724	Sy:170	Magnetic 5th	SYN	087	069	084
0725	Sy:171	DigimaX	SYN	087	069	085
0726	Sy:172	Exhale	SYN	087	069	086
0727	Sy:173	X-panda	SYN	087	069	087
0728	Sy:174	Saw Keystep	SYN	087	069	088
0729	Sy:175	Blue Meanie	SYN	087	069	089
0730	Sy:176	4mant Cycle	SYN	087	069	090
0731	Sy:177	Modular	SYN	087	069	091
0732	Sy:178	Analog Dream	SYN	087	069	092
0733	Sy:179	DCO Bell Pad	SYN	087	069	093
0734	Sy:180	Cell Fanta	SYN	087	069	094
0735	Sy:181	JUNO 5th	SYN	087	069	095
0736	Sy:182	DoubleBubble	SYN	087	069	096
0737	Sy:183	JUNO-D Maj7	TEK	087	069	097
0738	Sy:184	Sweet House	TEK	087	069	098
0739	Sy:185	Periscope	TEK	087	069	099
0740	Sy:186	5th Voice	TEK	087	069	100
0741	Sy:187	HPF Sweep	TEK	087	069	101
0742	Sy:188	BPF Saw	TEK	087	069	102
0743	Sy:189	Moon Synth	TEK	087	069	103
0744	Sy:190	DelyResoSaws	TEK	087	069	104
0745	Sy:191	JUNO Trance1	TEK	087	069	105
0746	Sy:192	Trancy Synth	TEK	087	069	106
0747	Sy:193	Cell Trance	TEK	087	069	107
0748	Sy:194	Trancy X	TEK	087	069	108
0749	Sy:195	JUNO Trance2	TEK	087	069	109
0750	Sy:196	R-Trance	TEK	087	069	110
0751	Sy:197	Braatz...	TEK	087	069	111
0752	Sy:198	AllinOneRiff	TEK	087	069	112
0753	Sy:199	YZ Again	TEK	087	069	113
0754	Sy:200	Flazy Lead	TEK	087	069	114
0755	Sy:201	Coffee Bee	TEK	087	069	115
0756	Sy:202	TB-Sequence	TEK	087	069	116
0757	Sy:203	SC-303	TEK	087	069	117
0758	Sy:204	Dance Saws	TEK	087	069	118
0759	Sy:205	AluminmWires	TEK	087	069	119
0760	Sy:206	Fred&Barney	TEK	087	069	120
0761	Sy:207	Electrostars	TEK	087	069	121
0762	Sy:208	LoFiSequence	TEK	087	069	122
0763	Sy:209	MelodicDrums	TEK	087	069	123
0764	Sy:210	Monkey Arpg	TEK	087	069	124
0765	Sy:211	TB Wah	TEK	087	069	125
0766	Sy:212	Waving TB303	TEK	087	069	126
0767	Sy:213	Digi Seq	TEK	087	069	127
0768	Sy:214	Seq Saw	TEK	087	069	128
0769	Sy:215	Reso Seq Saw	TEK	087	070	001
0770	Sy:216	DetuneSeqSaw	TEK	087	070	002
0771	Sy:217	Technotribe	TEK	087	070	003
0772	Sy:218	Teethy Grit	TEK	087	070	004
0773	Sy:219	Repertition	TEK	087	070	005
0774	Sy:220	Killerbeez	TEK	087	070	006
0775	Sy:221	Acid Lead	TEK	087	070	007
0776	Sy:222	Tranceformer	TEK	087	070	008
0777	Sy:223	Anadroid	TEK	087	070	009
0778	Sy:224	Shroomy	TEK	087	070	010
0779	Sy:225	Noize R us	TEK	087	070	011
0780	Sy:226	Beep Melodie	TEK	087	070	012
0781	Sy:227	Morpher	TEK	087	070	013

Patch List

No.	Name	Sub-category	MSB	LSB	PC	
0782	Sy:228	Power Synth	TEK	087	070	014
0783	Sy:229	Hoover Again	TEK	087	070	015
0784	Sy:230	Alpha Said..	TEK	087	070	016
0785	Sy:231	Ravers Awake	TEK	087	070	017
0786	Sy:232	Tekno Gargle	TEK	087	070	018
0787	Sy:233	Tranceiver	TEK	087	070	019
0788	Sy:234	Techno Dream	TEK	087	070	020
0789	Sy:235	Techno Pizz	TEK	087	070	021
0790	Sy:236	VirtualHuman	PLS	087	070	022
0791	Sy:237	Strobot	PLS	087	070	023
0792	Sy:238	Strobe	PLS	087	070	024
0793	Sy:239	Strobe X	PLS	087	070	025
0794	Sy:240	Mr. Fourier	PLS	087	070	026
0795	Sy:241	Rhythmic 5th	PLS	087	070	027
0796	Sy:242	Sorry4theDLY	PLS	087	070	028
0797	Sy:243	Cell Pad	PLS	087	070	029
0798	Sy:244	Shape of X	PLS	087	070	030
0799	Sy:245	ShapeURMusic	PLS	087	070	031
0800	Sy:246	Synth Force	PLS	087	070	032
0801	Sy:247	Trance Split	PLS	087	070	033
0802	Sy:248	Step Trance	PLS	087	070	034
0803	Sy:249	Chop Synth	PLS	087	070	035
0804	Sy:250	Euro Teuro	PLS	087	070	036
0805	Sy:251	Auto Trance1	PLS	087	070	037
0806	Sy:252	Eureggae	PLS	087	070	038
0807	Sy:253	Beat Pad	PLS	087	070	039
0808	Sy:254	TMT Seq Pad	PLS	087	070	040
0809	Sy:255	ForYourBreak	PLS	087	070	041
0810	Sy:256	HPF Slicer	PLS	087	070	042
0811	Sy:257	Sliced Choir	PLS	087	070	043
0812	Sy:258	Digi-Doo	PLS	087	070	044
0813	Sy:259	PanningFrmnt	PLS	087	070	045
0814	Sy:260	Dirty Beat	PLS	087	070	046
0815	Sy:261	Electrons	PLS	087	070	047
0816	Sy:262	Protons	PLS	087	070	048
0817	Sy:263	Brisk Vortex	PLS	087	070	049
0818	Sy:264	Throbulax	PLS	087	070	050
0819	Sy:265	Lonizer	PLS	087	070	051
0820	Sy:266	diGital Pad	PLS	087	070	052
0821	Sy:267	StepPitShift	PLS	087	070	053
0822	Sy:268	Pad Pulses	PLS	087	070	054
0823	Sy:269	Seq-Pad 1	PLS	087	070	055
0824	Sy:270	DSP Chaos	PLS	087	070	056
0825	Sy:271	Dance floor	PLS	087	070	057
0826	Sy:272	Minor Thirds	PLS	087	070	058
0827	Sy:273	FX World	PLS	087	070	059
0828	Sy:274	Nu Trance X	PLS	087	070	060
0829	Sy:275	Auto 5thSaws	PLS	087	070	061
0830	Sy:276	Cross Talk	PLS	087	070	062
0831	Sy:277	Reanimation	PLS	087	070	063
0832	Sy:278	VoX Chopper	PLS	087	070	064
0833	Sy:279	Trevor's Pad	PLS	087	070	065
0834	Sy:280	Fantomas Pad	PLS	087	070	066
0835	Sy:281	Jazzy Arps	PLS	087	070	067
0836	Sy:282	Keep Running	PLS	087	070	068
0837	Sy:283	Step In	PLS	087	070	069
0838	Sy:284	Echo Echo	PLS	087	070	070
0839	Sy:285	Keep going	PLS	087	070	071
0840	Sy:286	Arposphere	PLS	087	070	072
0841	Sy:287	Voco Riff	PLS	087	070	073
0842	Sy:288	Pulsator	PLS	087	070	074
0843	Sy:289	Motion Bass	PLS	087	070	075
0844	Sy:290	Sine Magic	PLS	087	070	076
0845	Sy:291	JUNO-D Slice	PLS	087	070	077
0846	Sy:292	Pulsatron	PLS	087	070	078
0847	Sy:293	Mega Sync	PLS	087	070	079
0848	Sy:294	Passing by	FX	087	070	080
0849	Sy:295	Lazer Points	FX	087	070	081
0850	Sy:296	Retro Sci-Fi	FX	087	070	082
0851	Sy:297	Magic Chime	FX	087	070	083
0852	Sy:298	Try This!	FX	087	070	084
0853	Sy:299	New Planetz	FX	087	070	085
0854	Sy:300	Jet Noise	FX	087	070	086
0855	Sy:301	Chaos 2003	FX	087	070	087
0856	Sy:302	Control Room	FX	087	070	088
0857	Sy:303	OutOf sortz	FX	087	070	089
0858	Sy:304	Scatter	FX	087	070	090
0859	Sy:305	Low Beat-S	FX	087	070	091
0860	Sy:306	WaitnOutside	FX	087	070	092
0861	Sy:307	Breath Echo	FX	087	070	093
0862	Sy:308	SoundStrange	FX	087	070	094

No.	Name	Sub-category	MSB	LSB	PC	
0863	Sy:309	Cosmic Pulse	FX	087	070	095
0864	Sy:310	Faked Piano	FX	087	070	096
0865	Sy:311	JUNO Crystal	FX	087	070	097
0866	Sy:312	ResoSweep Dn	FX	087	070	098
0867	Sy:313	Zap B3 & C4	FX	087	070	099
0868	Sy:314	PolySweep Nz	FX	087	070	100
0869	Sy:315	Strange Land	FX	087	070	101
0870	Sy:316	S&H Voc	FX	087	070	102
0871	Sy:317	12th Planet	FX	087	070	103
0872	Sy:318	Scare	FX	087	070	104
0873	Sy:319	Hillside	FX	087	070	105
0874	Sy:320	Mod Scanner	FX	087	070	106
0875	Sy:321	SoundOnSound	FX	087	070	107
0876	Sy:322	Gasp	FX	087	070	108
0877	Sy:323	ResoSweep Up	FX	087	070	109
0878	Sy:324	Magic Wave	FX	087	070	110
0879	Sy:325	Shangri-La	FX	087	070	111
0880	Sy:326	CerealKiller	FX	087	070	112
0881	Sy:327	Cosmic Drops	FX	087	070	113
0882	Sy:328	Space Echo	FX	087	070	114
0883	Sy:329	Robot Sci-Fi	FX	087	070	115
0884	Vo:001	Jazz Scat	VOX	087	070	116
0885	Vo:002	Jazz Doos	VOX	087	070	117
0886	Vo:003	Choir Aahs 1	VOX	087	070	118
0887	Vo:004	Choir Aahs 2	VOX	087	070	119
0888	Vo:005	Choir Oohs	VOX	087	070	120
0889	Vo:006	AngelsChoir1	VOX	087	070	121
0890	Vo:007	AngelsChoir2	VOX	087	070	122
0891	Vo:008	Syn Opera	VOX	087	070	123
0892	Vo:009	Angelique	VOX	087	070	124
0893	Vo:010	Vox Pad 1	VOX	087	070	125
0894	Vo:011	Vox Pad 2	VOX	087	070	126
0895	Vo:012	Gospel Oohs	VOX	087	070	127
0896	Vo:013	Choir&Str	VOX	087	070	128
0897	Vo:014	SynVox 1	VOX	087	071	001
0898	Vo:015	SynVox 2	VOX	087	071	002
0899	Vo:016	Aah Vox	VOX	087	071	003
0900	Vo:017	Sweet Keys	VOX	087	071	004
0901	Vo:018	JUNO Synvox	VOX	087	071	005
0902	Vo:019	Uhhmm	VOX	087	071	006
0903	Vo:020	Morning Star	VOX	087	071	007
0904	Vo:021	BeautifulOne	VOX	087	071	008
0905	Vo:022	Ooze	VOX	087	071	009
0906	Vo:023	Aerial Choir	VOX	087	071	010
0907	Vo:024	3D Vox	VOX	087	071	011
0908	Vo:025	Sample Opera	VOX	087	071	012
0909	Vo:026	Film Cue	VOX	087	071	013
0910	Vo:027	Paradise	VOX	087	071	014
0911	Vo:028	Sad ceremony	VOX	087	071	015
0912	Vo:029	Lost Voices	VOX	087	071	016
0913	Vo:030	Beat Vox	VOX	087	071	017
0914	Vo:031	Talk 2 Me	VOX	087	071	018
0915	Vo:032	FM Vox	VOX	087	071	019
0916	Vo:033	Let's Talk!	VOX	087	071	020
0917	Vo:034	Voc:Di Robt	VOX	087	071	021
0918	Vo:035	Voc:Di Chr	VOX	087	071	022
0919	Vo:036	Voc:Di Ens	VOX	087	071	023
0920	Vo:037	Cosmic Rays	BPD	087	071	024
0921	Vo:038	Phaser Pad 1	BPD	087	071	025
0922	Vo:039	PhaseStrings	BPD	087	071	026
0923	Vo:040	Super SynStr	BPD	087	071	027
0924	Vo:041	80s Str 1	BPD	087	071	028
0925	Vo:042	80s Str 2	BPD	087	071	029
0926	Vo:043	BreakOut Str	BPD	087	071	030
0927	Vo:044	Friends Syn	BPD	087	071	031
0928	Vo:045	Comb	BPD	087	071	032
0929	Vo:046	Voyager	BPD	087	071	033
0930	Vo:047	Stringship	BPD	087	071	034
0931	Vo:048	DarknessSide	BPD	087	071	035
0932	Vo:049	Fat Stacks	BPD	087	071	036
0933	Vo:050	Strings R Us	BPD	087	071	037
0934	Vo:051	Electric Pad	BPD	087	071	038
0935	Vo:052	Neo RS-202	BPD	087	071	039
0936	Vo:053	OB Rezo Pad	BPD	087	071	040
0937	Vo:054	Synthi Ens	BPD	087	071	041
0938	Vo:055	Giant Sweep	BPD	087	071	042
0939	Vo:056	Mod Dare	BPD	087	071	043
0940	Vo:057	Cell Space	BPD	087	071	044
0941	Vo:058	Digi-Swell	BPD	087	071	045
0942	Vo:059	New Year Day	BPD	087	071	046
0943	Vo:060	Polar Morn	BPD	087	071	047

No.	Name	Sub-category	MSB	LSB	PC	
0944	Vo:061	Distant Sun	BPD	087	071	048
0945	Vo:062	PG Chimes	BPD	087	071	049
0946	Vo:063	Saturn Rings	BPD	087	071	050
0947	Vo:064	Brusky	BPD	087	071	051
0948	Vo:065	2.2 Pad 1	BPD	087	071	052
0949	Vo:066	2.2 Pad 2	BPD	087	071	053
0950	Vo:067	2.2 Pad 3	BPD	087	071	054
0951	Vo:068	SaturnHolida	BPD	087	071	055
0952	Vo:069	Neuro-Drone	BPD	087	071	056
0953	Vo:070	In The Pass	BPD	087	071	057
0954	Vo:071	Polar Night	BPD	087	071	058
0955	Vo:072	Cell 5th	BPD	087	071	059
0956	Vo:073	MistOver5ths	BPD	087	071	060
0957	Vo:074	Gritty Pad	BPD	087	071	061
0958	Vo:075	India Garden	BPD	087	071	062
0959	Vo:076	BillionStars	BPD	087	071	063
0960	Vo:077	Sand Pad	BPD	087	071	064
0961	Vo:078	ReverseSweep	BPD	087	071	065
0962	Vo:079	HugeSoundMod	BPD	087	071	066
0963	Vo:080	Metal Swell	BPD	087	071	067
0964	Vo:081	NuSoundtrack	BPD	087	071	068
0965	Vo:082	Phat Strings	BPD	087	071	069
0966	Vo:083	Hollow	SPD	087	071	070
0967	Vo:084	Heaven Pad	SPD	087	071	071
0968	Vo:085	Soft OB Pad	SPD	087	071	072
0969	Vo:086	Reso Pad	SPD	087	071	073
0970	Vo:087	Slow Saw Str	SPD	087	071	074
0971	Vo:088	Terra Nostra	SPD	087	071	075
0972	Vo:089	Summer Pad	SPD	087	071	076
0973	Vo:090	Friends Pad	SPD	087	071	077
0974	Vo:091	Pop Pad	SPD	087	071	078
0975	Vo:092	Sqr Pad	SPD	087	071	079
0976	Vo:093	Silk Pad	SPD	087	071	080
0977	Vo:094	WarmReso Pad	SPD	087	071	081
0978	Vo:095	Soft Pad	SPD	087	071	082
0979	Vo:096	Air Pad	SPD	087	071	083
0980	Vo:097	Soft Breeze	SPD	087	071	084
0981	Vo:098	JP Strings 1	SPD	087	071	085
0982	Vo:099	JP Strings 2	SPD	087	071	086
0983	Vo:100	DelayStrings	SPD	087	071	087
0984	Vo:101	NorthStrings	SPD	087	071	088
0985	Vo:102	Syn Strings1	SPD	087	071	089
0986	Vo:103	Syn Strings2	SPD	087	071	090
0987	Vo:104	OB Strings 1	SPD	087	071	091
0988	Vo:105	OB Strings 2	SPD	087	071	092
0989	Vo:106	Strings Pad	SPD	087	071	093
0990	Vo:107	R&B SoftPad	SPD	087	071	094
0991	Vo:108	Phat Pad	SPD	087	071	095
0992	Vo:109	Phaser Pad 2	SPD	087	071	096
0993	Vo:110	Mystic Str	SPD	087	071	097
0994	Vo:111	Glass Organ	SPD	087	071	098
0995	Vo:112	Wind Pad	SPD	087	071	099
0996	Vo:113	Combination	SPD	087	071	100
0997	Vo:114	HumanKindnes	SPD	087	071	101
0998	Vo:115	Beauty Pad	SPD	087	071	102
0999	Vo:116	Atmospherics	SPD	087	071	103
1000	Vo:117	OB Aaahs	SPD	087	071	104
1001	Vo:118	Vulcano Pad	SPD	087	071	105
1002	Vo:119	Cloud #9	SPD	087	071	106
1003	Vo:120	Organic Pad	SPD	087	071	107
1004	Vo:121	Hum Pad	SPD	087	071	108
1005	Vo:122	Vox Pad	SPD	087	071	109
1006	Vo:123	Digital Aahs	SPD	087	071	110
1007	Vo:124	Tri 5th Pad	SPD	087	071	111
1008	Vo:125	Movin Pad	SPD	087	071	112
1009	Vo:126	Seq-Pad 2	SPD	087	071	113
1010	Vo:127	Follow	SPD	087	071	114
1011	Vo:128	Consolament	SPD	087	071	115
1012	Vo:129	Spacious Pad	SPD	087	071	116
1013	Vo:130	JD Pop Pad	SPD	087	071	117
1014	Vo:131	JP-8 Phase	SPD	087	071	118
1015	Vo:132	Nu Epic Pad	SPD	087	071	119
1016	Vo:133	Flange Dream	SPD	087	071	120
1017	Vo:134	Evolution X	SPD	087	071	121
1018	Vo:135	Angelis Pad	SPD	087	071	122
1019	Vo:136	JUNO-106 Str	SPD	087	071	123
1020	Vo:137	JupiterMoves	SPD	087	071	124
1021	Vo:138	Oceanic Pad	SPD	087	071	125
1022	Vo:139	Fairy's Song	SPD	087	071	126
1023	Vo:140	Borealis	SPD	087	071	127
1024	Vo:141	JX Warm Pad	SPD	087	071	128

No.	Name	Sub-category	MSB	LSB	PC	
1025	Vo:142	Analog Bgrnd	SPD	087	072	001
1026	Wr:001	Sitar on C	PLK	087	072	002
1027	Wr:002	JUNO Sitar 1	PLK	087	072	003
1028	Wr:003	JUNO Sitar 2	PLK	087	072	004
1029	Wr:004	Sitar Baby	PLK	087	072	005
1030	Wr:005	Neo Sitar	PLK	087	072	006
1031	Wr:006	SaraswatiRivr	PLK	087	072	007
1032	Wr:007	Teky Drop	PLK	087	072	008
1033	Wr:008	TroubadorEns	PLK	087	072	009
1034	Wr:009	Elec Sitar	PLK	087	072	010
1035	Wr:010	Pat is away	PLK	087	072	011
1036	Wr:011	Nice Kalimba	PLK	087	072	012
1037	Wr:012	Quiet River	PLK	087	072	013
1038	Wr:013	Aerial Harp	PLK	087	072	014
1039	Wr:014	Harpiness	PLK	087	072	015
1040	Wr:015	Skydiver	PLK	087	072	016
1041	Wr:016	Jamisen	PLK	087	072	017
1042	Wr:017	JUNO Koto	PLK	087	072	018
1043	Wr:018	Monsoon	PLK	087	072	019
1044	Wr:019	Bend Koto	PLK	087	072	020
1045	Wr:020	JUNO Banjo	FRT	087	072	021
1046	Wr:021	Pan Pipes	ETH	087	072	022
1047	Wr:022	Andes Mood	ETH	087	072	023
1048	Wr:023	LongDistance	ETH	087	072	024
1049	Wr:024	Ambi Shaku	ETH	087	072	025
1050	Wr:025	HimalayaPipe	ETH	087	072	026
1051	Wr:026	Ethnic Lead	ETH	087	072	027
1052	Wr:027	Lochscape	ETH	087	072	028
1053	Wr:028	PipeDream	ETH	087	072	029
1054	Wr:029	Angel Pipes	ETH	087	072	030
1055	Wr:030	Far East	ETH	087	072	031
1056	Wr:031	Wired Synth	ETH	087	072	032
1057	Wr:032	4DaCommonMan	ETH	087	072	033
1058	Wr:033	Orgaenia	ETH	087	072	034
1059	Wr:034	Sleeper	ETH	087	072	035
1060	Wr:035	Ice Palace	ETH	087	072	036
1061	Wr:036	Story Harp	ETH	087	072	037
1062	Wr:037	LostParadise	ETH	087	072	038
1063	Wr:038	Timpani+Low	PRC	087	072	039
1064	Wr:039	Timpani Roll	PRC	087	072	040
1065	Wr:040	Bass Drum	PRC	087	072	041
1066	Wr:041	Ambidextrous	SFX	087	072	042
1067	Wr:042	En-co-re	SFX	087	072	043
1068	Wr:043	Mobile Phone	SFX	087	072	044
1069	Wr:044	ElectroDisco	BTS	087	072	045
1070	Wr:045	Groove 007	BTS	087	072	046
1071	Wr:046	In Da Groove	BTS	087	072	047
1072	Wr:047	Sweet 80s	BTS	087	072	048
1073	Wr:048	Auto Trance2	BTS	087	072	049
1074	Wr:049	JUNO Pop	BTS	087	072	050
1075	Wr:050	Compusonic 1	BTS	087	072	051
1076	Wr:051	Compusonic 2	BTS	087	072	052
1077	Wr:052	Mix Drum 1	DRM	087	072	053
1078	Wr:053	Mix Drum 2	DRM	087	072	054
1079	Wr:054	Lounge Kit	CMB	087	072	055
1080	Wr:055	80s Combo	CMB	087	072	056
1081	Wr:056	Analog Days	CMB	087	072	057
1082	Wr:057	Techno Craft	CMB	087	072	058
1083	Sp:001	NylonGtr E4	SMP	087	072	059
1084	Sp:002	Pemade C5	SMP	087	072	060
1085	Sp:003	Shankh G#4	SMP	087	072	061
1086	Sp:004	RSS SpinnrC4	SMP	087	072	062
1087	SP:005	Come On! C4	SMP	087	072	063
1088	Sp:006	102:PhraseC4	SMP	087	072	064

Bank: GM

No.	Name	Sub-category	MSB	LSB	PC
0001	Pf:111 Piano 1	PNO	121	0	1
0002	Pf:112 Piano 1w	PNO	121	1	
0003	Pf:113 European Pf	PNO	121	2	
0004	Pf:114 Piano 2	PNO	121	0	2
0005	Pf:115 Piano 2w	PNO	121	1	
0006	Pf:116 Piano 3	EP	121	0	3
0007	Pf:117 Piano 3w	EP	121	1	
0008	Pf:118 Honky-tonk	PNO	121	0	4
0009	Pf:119 Honky-tonk 2	PNO	121	1	
0010	Pf:120 E.Piano 1	EP	121	0	5
0011	Pf:121 St.Soft EP	EP	121	1	
0012	Pf:122 FM+SA EP	EP	121	2	
0013	Pf:123 Wurly	EP	121	3	
0014	Pf:124 E.Piano 2	EP	121	0	6
0015	Pf:125 Detuned EP 2	EP	121	1	
0016	Pf:126 St.FM EP	EP	121	2	
0017	Pf:127 EP Legend	EP	121	3	
0018	Pf:128 EP Phase	EP	121	4	
0019	Ky:125 Harpsichord	KEY	121	0	7
0020	Ky:126 Coupled Hps.	KEY	121	1	
0021	Ky:127 Harpsi.w	KEY	121	2	
0022	Ky:128 Harpsi.o	KEY	121	3	
0023	Ky:129 Clav.	KEY	121	0	8
0024	Ky:130 Pulse Clav	KEY	121	1	
0025	Ky:131 Celesta	KEY	121	0	9
0026	Ky:132 Glockenspiel	BEL	121	0	10
0027	Ky:133 Music Box	BEL	121	0	11
0028	Ky:134 Vibraphone	MLT	121	0	12
0029	Ky:135 Vibraphone w	MLT	121	1	
0030	Ky:136 Marimba	MLT	121	0	13
0031	Ky:137 Marimba w	MLT	121	1	
0032	Ky:138 Xylophone	MLT	121	0	14
0033	Ky:139 Tubular-bell	BEL	121	0	15
0034	Ky:140 Church Bell	BEL	121	1	
0035	Ky:141 Carillon	BEL	121	2	
0036	Wr:058 Santur	PLK	121	0	16
0037	Ky:142 Organ 1	ORG	121	0	17
0038	Ky:143 Trem. Organ	ORG	121	1	
0039	Ky:144 60's Organ 1	ORG	121	2	
0040	Ky:145 70's E.Organ	ORG	121	3	
0041	Ky:146 Organ 2	ORG	121	0	18
0042	Ky:147 Chorus Or.2	ORG	121	1	
0043	Ky:148 Perc. Organ	ORG	121	2	
0044	Ky:149 Organ 3	ORG	121	0	19
0045	Ky:150 Church Org.1	ORG	121	0	20
0046	Ky:151 Church Org.2	ORG	121	1	
0047	Ky:152 Church Org.3	ORG	121	2	
0048	Ky:153 Reed Organ	ORG	121	0	21
0049	Ky:154 Puff Organ	ORG	121	1	
0050	Ky:155 Accordion Fr	ACD	121	0	22
0051	Ky:156 Accordion It	ACD	121	1	
0052	Ky:157 Harmonica	HRM	121	0	23
0053	Ky:158 Bandoneon	ACD	121	0	24
0054	Gt:176 Nylon-str.Gt	AGT	121	0	25
0055	Gt:177 Ukulele	AGT	121	1	
0056	Gt:178 Nylon Gt.o	AGT	121	2	
0057	Gt:179 Nylon Gt.2	AGT	121	3	
0058	Gt:180 Steel-str.Gt	AGT	121	0	26
0059	Gt:181 12-str.Gt	AGT	121	1	
0060	Gt:182 Mandolin	AGT	121	2	
0061	Gt:183 Steel + Body	AGT	121	3	
0062	Gt:184 Jazz Gt.	EGT	121	0	27
0063	Gt:185 Pedal Steel	EGT	121	1	
0064	Gt:186 Clean Gt.	EGT	121	0	28
0065	Gt:187 Chorus Gt.	EGT	121	1	
0066	Gt:188 Mid Tone GTR	EGT	121	2	
0067	Gt:189 Muted Gt.	EGT	121	0	29
0068	Gt:190 Funk Pop	EGT	121	1	
0069	Gt:191 Funk Gt.2	EGT	121	2	
0070	Gt:192 Jazz Man	EGT	121	3	
0071	Gt:193 Overdrive Gt	DGT	121	0	30
0072	Gt:194 Guitar Pinch	DGT	121	1	
0073	Gt:195 DistortionGt	DGT	121	0	31
0074	Gt:196 Feedback Gt.	DGT	121	1	
0075	Gt:197 Dist Rtm GTR	DGT	121	2	
0076	Gt:198 Gt.Harmonics	EGT	121	0	32
0077	Gt:199 Gt. Feedback	EGT	121	1	
0078	Gt:200 Acoustic Bs.	BS	121	0	33
0079	Gt:201 Fingered Bs.	BS	121	0	34

No.	Name	Sub-category	MSB	LSB	PC
0080	Gt:202 Finger Slap	BS	121	1	
0081	Gt:203 Picked Bass	BS	121	0	35
0082	Gt:204 Fretless Bs.	BS	121	0	36
0083	Gt:205 Slap Bass 1	BS	121	0	37
0084	Gt:206 Slap Bass 2	BS	121	0	38
0085	Gt:207 Synth Bass 1	SBS	121	0	39
0086	Gt:208 SynthBass101	SBS	121	1	
0087	Gt:209 Acid Bass	SBS	121	2	
0088	Gt:210 Clavi Bass	SBS	121	3	
0089	Gt:211 Hammer	SBS	121	4	
0090	Gt:212 Synth Bass 2	SBS	121	0	40
0091	Gt:213 Beef FM Bass	SBS	121	1	
0092	Gt:214 RubberBass 2	SBS	121	2	
0093	Gt:215 Attack Pulse	SBS	121	3	
0094	Oc:070 Violin	STR	121	0	41
0095	Oc:071 Slow Violin	STR	121	1	
0096	Oc:072 Viola	STR	121	0	42
0097	Oc:073 Cello	STR	121	0	43
0098	Oc:074 Contrabass	STR	121	0	44
0099	Oc:075 Tremolo Str	STR	121	0	45
0100	Oc:076 PizzicatoStr	STR	121	0	46
0101	Wr:059 Harp	PLK	121	0	47
0102	Wr:060 Yang Qin	PLK	121	1	
0103	Wr:061 Timpani	PRC	121	0	48
0104	Oc:077 Strings	STR	121	0	49
0105	Oc:078 Orchestra	ORC	121	1	
0106	Oc:079 60s Strings	STR	121	2	
0107	Oc:080 Slow Strings	STR	121	0	50
0108	Oc:081 Syn.Strings1	STR	121	0	51
0109	Oc:082 Syn.Strings3	STR	121	1	
0110	Vo:143 Syn.Strings2	SPD	121	0	52
0111	Vo:144 Choir Aahs	VOX	121	0	53
0112	Vo:145 Chorus Aahs	VOX	121	1	
0113	Vo:146 Voice Oohs	VOX	121	0	54
0114	Vo:147 Humming	VOX	121	1	
0115	Vo:148 SynVox	VOX	121	0	55
0116	Vo:149 Analog Voice	VOX	121	1	
0117	Oc:083 OrchestraHit	HIT	121	0	56
0118	Oc:084 Bass Hit	HIT	121	1	
0119	Oc:085 6th Hit	HIT	121	2	
0120	Oc:086 Euro Hit	HIT	121	3	
0121	Br:077 Trumpet	BRS	121	0	57
0122	Br:078 Dark Trumpet	BRS	121	1	
0123	Br:079 Trombone	BRS	121	0	58
0124	Br:080 Trombone 2	BRS	121	1	
0125	Br:081 Bright Tb	BRS	121	2	
0126	Br:082 Tuba	BRS	121	0	59
0127	Br:083 MutedTrumpet	BRS	121	0	60
0128	Br:084 MuteTrumpet2	BRS	121	1	
0129	Br:085 French Horns	BRS	121	0	61
0130	Br:086 Fr.Horn 2	BRS	121	1	
0131	Br:087 Brass 1	BRS	121	0	62
0132	Br:088 Brass 2	BRS	121	1	
0133	Br:089 Synth Brass1	SBR	121	0	63
0134	Br:090 Pro Brass	SBR	121	1	
0135	Br:091 Oct SynBrass	SBR	121	2	
0136	Br:092 Jump Brass	SBR	121	3	
0137	Br:093 Synth Brass2	SBR	121	0	64
0138	Br:094 SynBrass sfz	SBR	121	1	
0139	Br:095 Velo Brass 1	SBR	121	2	
0140	Br:096 Soprano Sax	SAX	121	0	65
0141	Br:097 Alto Sax	SAX	121	0	66
0142	Br:098 Tenor Sax	SAX	121	0	67
0143	Br:099 Baritone Sax	SAX	121	0	68
0144	Br:100 Oboe	WND	121	0	69
0145	Br:101 English Horn	WND	121	0	70
0146	Br:102 Bassoon	WND	121	0	71
0147	Br:103 Clarinet	WND	121	0	72
0148	Br:104 Piccolo	FLT	121	0	73
0149	Br:105 Flute	FLT	121	0	74
0150	Br:106 Recorder	FLT	121	0	75
0151	Br:107 Pan Flute	FLT	121	0	76
0152	Br:108 Bottle Blow	FLT	121	0	77
0153	Wr:062 Shakuhachi	ETH	121	0	78
0154	Br:109 Whistle	FLT	121	0	79
0155	Br:110 Ocarina	FLT	121	0	80
0156	Sy:330 Square Wave	HLD	121	0	81
0157	Sy:331 MG Square	HLD	121	1	
0158	Sy:332 2600 Sine	HLD	121	2	
0159	Sy:333 Saw Wave	HLD	121	0	82
0160	Sy:334 OB2 Saw	HLD	121	1	

No.	Name	Sub-category	MSB	LSB	PC
0161	Sy:335	Doctor Solo	HLD	121	2
0162	Sy:336	Natural Lead	HLD	121	3
0163	Sy:337	SequencedSaw	HLD	121	4
0164	Sy:338	Syn.Calliope	SLD	121	0 83
0165	Sy:339	Chiffer Lead	SLD	121	0 84
0166	Sy:340	Charang	HLD	121	0 85
0167	Sy:341	Wire Lead	HLD	121	1
0168	Sy:342	Solo Vox	SLD	121	0 86
0169	Sy:343	5th Saw Wave	HLD	121	0 87
0170	Sy:344	Bass & Lead	HLD	121	0 88
0171	Sy:345	Delayed Lead	HLD	121	1
0172	Sy:346	Fantasia	SYN	121	0 89
0173	Vo:150	Warm Pad	SPD	121	0 90
0174	Vo:151	Sine Pad	SPD	121	1
0175	Sy:347	Polysynth	SYN	121	0 91
0176	Vo:152	Space Voice	VOX	121	0 92
0177	Vo:153	Itopia	VOX	121	1
0178	Vo:154	Bowed Glass	SPD	121	0 93
0179	Vo:155	Metal Pad	BPD	121	0 94
0180	Vo:156	Halo Pad	BPD	121	0 95
0181	Vo:157	Sweep Pad	SPD	121	0 96
0182	Sy:348	Ice Rain	SYN	121	0 97
0183	Vo:158	Soundtrack	SPD	121	0 98
0184	Ky:159	Crystal	BEL	121	0 99
0185	Ky:160	Syn Mallet	BEL	121	1
0186	Gt:216	Atmosphere	AGT	121	0 100
0187	Sy:349	Brightness	SYN	121	0 101
0188	Sy:350	Goblin	PLS	121	0 102
0189	Vo:159	Echo Drops	BPD	121	0 103
0190	Vo:160	Echo Bell	BPD	121	1
0191	Vo:161	Echo Pan	BPD	121	2
0192	Vo:162	Star Theme	BPD	121	0 104
0193	Wr:063	Sitar	PLK	121	0 105
0194	Wr:064	Sitar 2	PLK	121	1
0195	Wr:065	Banjo	FRT	121	0 106
0196	Wr:066	Shamisen	PLK	121	0 107
0197	Wr:067	Koto	PLK	121	0 108
0198	Wr:068	Taisho Koto	PLK	121	1
0199	Wr:069	Kalimba	PLK	121	0 109
0200	Wr:070	Bagpipe	ETH	121	0 110
0201	Oc:087	Fiddle	STR	121	0 111
0202	Wr:071	Shanai	ETH	121	0 112
0203	Ky:161	Tinkle Bell	BEL	121	0 113
0204	Wr:072	Agogo	PRC	121	0 114
0205	Ky:162	Steel Drums	MLT	121	0 115
0206	Wr:073	Woodblock	PRC	121	0 116
0207	Wr:074	Castanets	PRC	121	1
0208	Wr:075	Taiko	PRC	121	0 117
0209	Wr:076	Concert BD	PRC	121	1
0210	Wr:077	Melo. Tom 1	PRC	121	0 118
0211	Wr:078	Melo. Tom 2	PRC	121	1
0212	Wr:079	Synth Drum	PRC	121	0 119
0213	Wr:080	808 Tom	PRC	121	1
0214	Wr:081	Elec Perc	PRC	121	2
0215	Wr:082	Reverse Cym.	PRC	121	0 120
0216	Gt:217	Gt.FretNoise	AGT	121	0 121
0217	Gt:218	Gt.Cut Noise	AGT	121	1
0218	Gt:219	String Slap	AGT	121	2
0219	Sy:351	Breath Noise	FX	121	0 122
0220	Sy:352	Fl.Key Click	FX	121	1
0221	Wr:083	Seashore	SFX	121	0 123
0222	Wr:084	Rain	SFX	121	1
0223	Wr:085	Thunder	SFX	121	2
0224	Wr:086	Wind	SFX	121	3
0225	Wr:087	Stream	SFX	121	4
0226	Wr:088	Bubble	SFX	121	5
0227	Wr:089	Bird	SFX	121	0 124
0228	Wr:090	Dog	SFX	121	1
0229	Wr:091	Horse-Gallop	SFX	121	2
0230	Wr:092	Bird 2	SFX	121	3
0231	Wr:093	Telephone 1	SFX	121	0 125
0232	Wr:094	Telephone 2	SFX	121	1
0233	Wr:095	DoorCreaking	SFX	121	2
0234	Wr:096	Door	SFX	121	3
0235	Wr:097	Scratch	SFX	121	4
0236	Wr:098	Wind Chimes	SFX	121	5
0237	Wr:099	Helicopter	SFX	121	0 126
0238	Wr:100	Car-Engine	SFX	121	1
0239	Wr:101	Car-Stop	SFX	121	2
0240	Wr:102	Car-Pass	SFX	121	3
0241	Wr:103	Car-Crash	SFX	121	4

No.	Name	Sub-category	MSB	LSB	PC
0242	Wr:104	Siren	SFX	121	5
0243	Wr:105	Train	SFX	121	6
0244	Wr:106	Jetplane	SFX	121	7
0245	Wr:107	Starship	SFX	121	8
0246	Wr:108	Burst Noise	SFX	121	9
0247	Wr:109	Applause	SFX	121	0 127
0248	Wr:110	Laughing	SFX	121	1
0249	Wr:111	Screaming	SFX	121	2
0250	Wr:112	Punch	SFX	121	3
0251	Wr:113	Heart Beat	SFX	121	4
0252	Wr:114	Footsteps	SFX	121	5
0253	Wr:115	Gun Shot	SFX	121	0 128
0254	Wr:116	Machine Gun	SFX	121	1
0255	Wr:117	Lasergun	SFX	121	2
0256	Wr:118	Explosion	SFX	121	3

Performance List

No.	Name
001	Bass / Piano
002	Piano & Str
003	Big & Proud
004	Whale Pad
005	Dual Rotary
006	Mission DS
007	JUNO DS Lead
008	Choir Orche
009	Delicate
010	Asian Temple
011	The Leader
012	SolarEclipse
013	Proud Brass
014	Air Garden
015	Winter Bell

No.	Name
016	D-50Memories
017	Ambi Lead
018	Rock Organ
019	Notre-Dame
020	SuperSawStk
021	SatelliteGtr
022	Bright Pad
023	Pad/Sine Ld
024	Rock Unison
025	Super SynBrs
026	St Echo Lead
027	Flux Pad
028	Sweet Tekno
029	Twilight Pad
030	SonicVoyager

No.	Name
031	St Oct Lead
032	Personal Pad
033	Eden Gardens
034	Space Tale
035	SeqBs/Sft Ld
036	Gtr Heaven
037	Concert Str
038	Dual D-50
039	Wstmin Abbey
040	Choir & Orch
041	World Lead
042	CrystalGrand
043	Orchestral
044	80s Stack
045	Grand Ocean

No.	Name
046	Baby's Hand
047	Leading D/A
048	Horizon
049	TripTo 80s
050	Blizzard
051	WoodyFlt Ld
052	3AM
053	Synchronize
054	Additive Pad
055	The Pipes
056	Space Walk
057	Tibet Pad
058	XyloSaw Ld
059	Jupiters
060	Voc:Di + Bs

No.	Name
061	Voc:Di + Org
062	Voc:Di + Pad
063	Seq:Template
064	GM2 Template

Drum Kit List

Bank: DS

No.	Name	MSB	LSB	PC
0001	Dr:S01 StudioKt DS1	086	065	001
0002	Dr:S02 StudioKt DS2	086	065	002
0003	Dr:S03 EEU-Oriental	086	065	003
0004	Dr:S04 808 Kit	086	065	004
0005	Dr:S05 909 Kit	086	065	005
0006	Dr:S06 EDM Kit 1	086	065	006
0007	Dr:S07 EDM Kit 2	086	065	007
0008	Dr:S08 Drum&Bs Kit	086	065	008
0009	Dr:S09 DanceMixKit	086	065	009

Bank: GM

No.	Name	MSB	LSB	PC
0001	Dr:022 GM2 STANDARD	120	0	001
0002	Dr:023 GM2 ROOM	120	0	009
0003	Dr:024 GM2 POWER	120	0	017
0004	Dr:025 GM2 ELECTRIC	120	0	025
0005	Dr:026 GM2 ANALOG	120	0	026
0006	Dr:027 GM2 JAZZ	120	0	033
0007	Dr:028 GM2 BRUSH	120	0	041
0008	Dr:029 GM2 ORCHSTRA	120	0	049
0009	Dr:030 GM2 SFX	120	0	057

Bank: PRST

No.	Name	MSB	LSB	PC
0001	Dr:001 Pop Kit 1	086	064	001
0002	Dr:002 Rock Kit	086	064	002
0003	Dr:003 Brush Jz Kit	086	064	003
0004	Dr:004 HipHop Kit	086	064	004
0005	Dr:005 R&B Kit	086	064	005
0006	Dr:006 Dance Kit 1	086	064	006
0007	Dr:007 Dance Kit 2	086	064	007
0008	Dr:008 Dance Kit 3	086	064	008
0009	Dr:009 Pop Kit 2	086	064	009
0010	Dr:010 Dance Kit 4	086	064	010
0011	Dr:011 Ambi Pop 1	086	064	011
0012	Dr:012 Ambi Rock	086	064	012
0013	Dr:013 Ambi BrushJz	086	064	013
0014	Dr:014 Ambi HipHop	086	064	014
0015	Dr:015 Ambi R&B	086	064	015
0016	Dr:016 Ambi Dance 1	086	064	016
0017	Dr:017 Ambi Dance 2	086	064	017
0018	Dr:018 Ambi Dance 3	086	064	018
0019	Dr:019 Ambi Pop 2	086	064	019
0020	Dr:020 Ambi Dance 4	086	064	020
0021	Dr:021 Latin Menu	086	064	021

Drum Kit Assign List

	DS: 0001. StudioKt DS1	DS: 0002. StudioKt DS2	DS: 0003. EEU-Oriental	DS: 0004. 808 Kit	DS: 0005. 909 Kit
	-----	-----	BB2-SlideBs1	-----	-----
21	22 MC-500 Beep1	MC-500 Beep1	BB2-SlideBs2	-----	-----
23	MC-500 Beep2	MC-500 Beep2	FG.TR909Clap	-----	-----
C1					
24	25 Concert SD	Concert SD	Tamarin 2	-----	-----
	Snare Roll 1	Snare Roll 1	VA.Cha2Bell1	-----	-----
26	Finger Snap2	Finger Snap2	EEU-ViolnS11	-----	-----
27	High Q	High Q	EEU-ViolnS12	-----	-----
28	Slap	Slap	EEU-E.VlnS11	-----	-----
	Scratch Push	Scratch Push	EEU-E.VlnS12	-----	-----
29	Scratch Pull	Scratch Pull	EM.Tbl2 Dom	-----	-----
30	Sticks	Sticks	EM.Tbl2 Tak1	Kick1	Kick1
31	Reg.PHH [M1]	Reg.PHH [M1]	EM.Tbl2 Rim1	Snare Ghost1	Snare Ghost1
32	Hand Clap	Hand Clap	TR909 Clap 1	Kick2	909 Kick 1
33	Snare Roll 2	Snare Roll 2	Reg.PHH [M1]	Pedal Hihat [M1]	Pedal Hihat [M1]
34	Warm Kick	Warm Kick	SC.TR909 BD2	808 Kick 1 [M1]	909 Kick 3 [M1]
C2					
36	37 Hush Kick	Hush Kick	EEU-BsDrm	808 Kick 2	909 Kick 2
	WoodSideStk	Br.SideStk	EEU-CrsStk	808 Rim	909 Rimshot
38	TitanSnr	Br.Snr 1	EEU-Snare 1	808 Snare 1	909 Snare 1
39	T.Snr Ghst	IronSnrGst	Reg.SnrGst	808 Clap	909 Clap
40	T.Snr RS	Br.Snr 2	EEU-Snare 2	808 Snare 2	909 Snare 2
	StudioT4	StudioT4	EEU-LTom2	808 Low Tom	909 Low Tom
41	42 Reg.CHH 1 [M1]	Reg.CHH 1 [M1]	EEU-HH Cl1 [M1]	808 Cl HH [M1]	909 Cl HH [M1]
	StudioT3	StudioT3	EEU-LTom1	808 Low Tom	909 L DstTom
43	44 Reg.CHH 2 [M1]	Reg.CHH 2 [M1]	EEU-HH Cl2 [M1]	808 Pedal HH [M1]	909 Pedal HH [M1]
	StudioT3	StudioT3	EEU-MTom2	808 Mid Tom	909 Mid Tom
45	46 Reg.OHH [M1]	Reg.OHH [M1]	EEU-HH Op [M1]	808 Open HH [M1]	909 Open HH [M1]
	StudioT2	StudioT2	EEU-MTom1	808 Mid Tom	909 M DstTom
C3					
48	49 StudioT2	StudioT2	EEU-HTom2	808 Hi Tom	909 Hi Tom
	Crash Cym	Crash Cym	EEU-Cr.Cym2	808 Cymbal	909 CrashCym
50	StudioT1	StudioT1	EEU-HTom1	808 Hi Tom	909 H DstTom
51	Rock Ride	Rock Ride	EEU-Ride	Ride Cymbal1	909 Ride Cym
52	Chinese Cym	Chinese Cym	EEU-ChnCym	China Cymbal	China Cymbal
	Rock Ride	Rock Ride	EEU-Ride Cup	Ride Cymbal2	Ride Cymbal2
53	54 Tambourine	Tambourine	Tambourine 3	Tambourine	Tambourine
	Splash Cym	Splash Cym	EEUSplashCym	SplashCymbal	SplashCymbal
55	56 Cowbell	Cowbell	Cowbell Mute	808 Cowbell	Cowbell
	Crash Cym	Crash Cym	EEU-Cr.Cym1	Crash Cymbal	CrashCymbal2
57	58 Vibra-slap	Vibra-slap	EM.DholaRaka	Vibraslap	Vibraslap
	Rock Ride	Rock Ride	EM.DholaTak1	Ride Cymbal3	Ride Cymbal3
C4					
60	61 StudioT4	High Bongo	EM.DholaTak2	High Bongo1	High Bongo1
	Low Bongo	Low Bongo	EM.DofDom 1	Low Bongo1	Low Bongo1
62	Mute HiConga	Mute HiConga	EM.DofDom 2	808 LowConga	Conga Slap
63	Open HiConga	Open HiConga	EM.DofDom 3	808 MidConga	OpenHi Conga
64	Open LoConga	Open LoConga	EM.DofTak 1	808 Hi Conga	Low Conga1
	High Timbale	High Timbale	EEU-TapanL	High Timbale	High Timbale
65	66 Low Timbale	Low Timbale	EM.DofSak 1	Low Timbale	Low Timbale
	High Agogo	High Agogo	EEU-TapanH	High Agogo	High Agogo
67	68 Low Agogo	Low Agogo	EM.DofSak 2	Low Agogo	Low Agogo
	Cabasa	Cabasa	EEU-TapanM	Cabasa	Cabasa
69	70 Maracas	Maracas	EM.DofSak 3	808 Maracas	Maracas
71	ShortWhistle	ShortWhistle	EEU-Tapan Fx	ShortWhistle [M2]	ShortWhistle [M2]
C5					
72	73 Long Whistle [M2]	Long Whistle [M2]	EM.DofFingr2	Long Whistle [M2]	Long Whistle [M2]
	Short Guiro [M2]	Short Guiro [M2]	EM.Tbl Raka1	Short Guiro [M3]	Short Guiro [M3]
74	Long Guiro [M2]	Long Guiro [M2]	EM.Tbl Tak 1	Long Guiro [M3]	Long Guiro [M3]
75	Claves	Claves	EM.Tbl Tik 1	808 Claves	Claves
76	Hi Wood Blck	Hi Wood Blck	EM.Tbl Dom 1	Hi WoodBlock	Hi WoodBlock
	Lo Wood Blck	Lo Wood Blck	EM.Tbl Sak 1 [M2]	LowWoodBlock	LowWoodBlock
77	78 Mute Cuica [M5]	Mute Cuica [M5]	EM.Tbl Roll [M2]	Mute Cuica [M4]	Mute Cuica [M4]
	Open Cuica [M5]	Open Cuica [M5]	EM.Tbl Tak 2 [M2]	Open Cuica [M4]	Open Cuica [M4]
79	80 MuteTriangle [M3]	MuteTriangle [M3]	EM.Tbl Raka2 [M2]	MuteTriangle [M5]	MuteTriangle [M5]
	OpenTriangle [M3]	OpenTriangle [M3]	EM.Tbl Rim 1 [M2]	OpenTriangle [M5]	OpenTriangle [M5]
81	82 Shaker	Shaker	EM.Tbl Toks1	Shaker	Shaker
83	Jingle Bell	Jingle Bell	EM.Tbl Rim 2	Castanet	Castanet
C6					
84	85 Wind Chime	Wind Chime	EM.Tbl Tik 2	High Bongo2	High Bongo2
	Castanets	Castanets	EM.Rek Raka	MtHigh Conga	MtHigh Conga
86	Mute Surdo [M4]	Mute Surdo [M4]	EM.Rek Dom	Low Bongo2	Low Bongo2
87	Open Surdo [M4]	Open Surdo [M4]	EM.Rek Trill	Low Bongo3	Low Bongo3
88	Applause 2	Applause 2	EM.Rek Tak 1	Low Conga2	Low Conga2
	-----	-----	EM.Rek Rim 1	Low Tom3	Low Tom3
89	90	-----	EM.Rek Brs 1	Low Tom4	Low Tom4
	-----	-----	EM.Rek Tok	Mix Kick1	Mix Kick1
91	92	-----	EM.Rek Brs 3	Mix Kick2	Mix Kick2
	-----	-----	EM.Rek Tak 2	Mix Kick3	Mix Kick3
93	94	-----	EM.REK Sak	Mix Kick4	Mix Kick4
	-----	-----	EM.Rek Tik	Mix Nz1	Mix Nz1
C7					
96	97 Std.1 Snare1	Std.1 Snare1	EM.MazharDom	Mix Nz2	Mix Nz2
	Std.1 Snare2	Std.1 Snare2	EM.MazharTak	Mix Nz3	Mix Nz3
98	99 Std 2 Snare1	Std 2 Snare1	EM.MazharSak	Wind Chime	Wind Chime
	Std 2 Snare2	Std 2 Snare2	EM.MazharBrs	Hand Clap1	Hand Clap1
100	Snare Drum 2	Snare Drum 2	EEUbnngL OP	Hand Clap2	Hand Clap2
101	102 Std 1 Snare1	Std 1 Snare1	EEUbnngL RM	-----	-----
	Std 1 Snare2	Std 1 Snare2	EEUbnngH OP	-----	-----
103	104 Std Snare 3	Std Snare 3	EEUbnngH RM	-----	-----
	Jazz Snare 1	Jazz Snare 1	EM.Dofs Tak	-----	-----
105	106 Jazz Snare 2	Jazz Snare 2	EM.Dofs Dom	-----	-----
	Room Snare 1	Room Snare 1	EM.Dofs Sak	-----	-----
107	Room Snare 2	Room Snare 2	EM.Dofs Rim1	-----	-----
C8					
108	Room Snare 2	Room Snare 2	EM.Dofs Rim2	-----	-----

----- : no sound

[M] : will not sound simultaneously with other percussion instruments of the same number

Performance List

	DS: 0006. StudioKt DS1	DS: 0007. StudioKt DS2	DS: 0008. EEU-Oriental	DS: 0009. 808 Kit		
	21	----	----	909 Kick		
	22	----	----	FingerSnaps		
	23	----	----	Id Snare		
C1	24	----	----	Fat Kick		
	25	----	----	Gospel Clap		
	26	----	----	HipHop Kick		
	27	----	----	Uno!		
	28	TR808 Kick	SH32 Kick1	Dos!		
		Mix Kick1	TR909 Kick1	Tres!		
	29	Mix Snare1	AnalogSnare1	Quatro!		
	30	Mix Kick2	Analog Kick1	Hey Brazil		
	31	Mix Snare2	TR808 Snare	Reg.CHH		
	32	Mix Kick3	SH32 Kick2	Sol Snare		
	33	Thin CIHH	Pedal Hihat	Gospel Clap		
	34	Mix Kick4	TR909 Kick2	Id Snare		
	35		[M1]	[M1]		
C2	36	909 Kick 1	Analog Kick2	Plastic Kick		
	37	Mix Rim1	Synth Rim	808 Rim		
	38	626 Snare	Clap&Snare 1	626 Snare		
	39	TR808 Clap	TR808 Clap1	Hand Clap		
	40	106 Snare	Clap&Snare 2	Gospel Clap		
	41	Mix Tom1	Deep Tom1	Gospel Clap		
	42	Mix CIHH1	Reg.CHH	808 CHH	[M1]	
	43	Mix Tom2	Deep Tom1	Reg.F.Tom	808 Low Tom	
	44	Mix CIHH2	Reg.PHH	CI Hihat2	808 PHH	[M1]
	45	Mix Tom3	Deep Tom2	Reg.M.Tom	808 Mid Tom	
	46	Op Hihat	Reg.OHH	Op Hihat1	909 OHH	[M1]
	47	Mix Tom3	Deep Tom2	Reg.M.Tom	808 Mid Tom	
C3	48	Mix Tom4	Deep Tom3	Reg.H.Tom	808 Hi Tom	
	49	Crash Cymbal	Rock Crash	CrashCymbal1	909 CrashCym	
	50	Mix Tom4	Deep Tom3	Reg.H.Tom	808 Hi Tom	
	51	TR909 Ride	Wide Syn Cym	Ride Cymbal1	Ride Cymbal	
	52	China Cymbal	TR808 Cym2	Rock Chash	China Cymbal	
	53	Ride Cymbal	China Cym1	Ride Cup	909 Ride Cym	
	54	Tambourine	Castanet	Tambourine1	Tambourine	
	55	Rock Crash	TR808 Cym3	Syn Swt Atk1	SplashCymbal	
	56	Cowbell	Syn Cowbell	Agogo Noise	808 Cowbell	
	57	Concert Cym	China Cym2	MG Zap1	Crash Cymbal	
	58	Vibraslap	Syn Swt Atk1	Syn Swt Atk2	Vibraslap	
	59	TR808 Cym	TR909 Kick3	TR909 Kick4	Ride Cymbal	
C4	60	Bongo1	Analog Kick3	SH32 Kick3	High Bongo1	
	61	Bongo2	Syn Stick	TR808 Rim2	Low Bongo1	
	62	Bongo&Conga1	AnalogSnare2	TR808 Snare1	808 LowConga	
	63	Conga	TR808 Clap2	TR808 Clap1	808 MidConga	
	64	Bongo&Conga2	AnalogSnare3	Analog Snare	808 Hi Conga	
	65	TR808 Conga	Shaker1	Mid Tom1	High Timbale	
	66	Maracas	Syn CIHH1	Noise CIHH	Low Timbale	[M1]
	67	Shaker	Shaker2	Mid Tom2	High Agogo	
	68	Triangle1	Syn CIHH2	CI Hihat3	Low Agogo	[M1]
	69	Cabasa	Atmosphere1	Mid Tom3	Cabasa	
	70	Guiro	Syn OpHH	Op Hihat2	808 Maracas	[M1]
	71	Street OpHH	Atmosphere2	Mid Tom4	ShortWhistle	[M2]
C5	72	Scratch	Atmosphere3	Mid Tom5	Long Whistle	[M2]
	73	Mix Atk1	TR808 Cym4	Rock Crash2	Short Guiro	[M3]
	74	MG Zap	Atmosphere4	Mid Tom6	Long Guiro	[M3]
	75	Syn Swt Atk1	Mix Ride	SplashCymbal	808 Claves	
	76	Syn Swt Atk2	China Cym3	Rock Crash3	Hi WoodBlock	
	77	Cuica Low	Rock Rd Edge	Rock Rd Edge	LowWoodBlock	
	78	Triangle2	Syn Slap	Tambourine2	Mute Cuica	[M4]
	79	Triangle3	MG Zap1	Syn Swt Atk3	Open Cuica	[M4]
	80	Triangle4	SynVox Noise	Cowbell1	MuteTriangle	[M5]
	81	Mix Hit1	MG Zap2	Syn Swt Atk4	OpenTriangle	[M5]
	82	Mix Hit2	Syn Swt Atk2	Cowbell2	Shaker	
	83	Mix Hit3	MG Zap3	MG Zap3	Castanet	
C6	84	Wind Chime	808 Maracas	Low Bongo	High Bongo	
	85	Timpani Roll	TR808 Claves	MtHigh Conga	MtHigh Conga	
	86	Crotale	MuteTriangle	Conga Slap	Low Bongo	
	87	R8 Click	OpenTriangle	OpHigh Conga	Low Bongo	
	88	Metro Bell	Mix Hit	Op Low Conga	Low Conga	
	89	DR202 Beep 1	Scratch	High Timbale	Fuego!	
	90	DR202 Beep 2	Easy Gtr	Low Timbale	Tiquitito!	
	91	Sweep Down1	Syn Bel Atk	High Agogo	Grito-Oa Oa!	
	92	Sweep Up	MG Attack	Low Agogo	Mix Kick	
	93	Sweep Down2	SynSnareRoll	Cabasa	MG Zap	
	94	Light Wood	Syn Burst Nz	Maracas	808 Snare	
	95	Laser	White Noise	Short Guiro	Reverse Cym	[M2]
C7	96	Low Atk	Polishing Nz	Long Guiro	Mix Noise	[M2]
	97	Analog Kick	Long Guiro	Claves	909 Crash	
	98	Old Kick	Light Wood	LowWoodBlock	ReverseClap	
	99	Mix Kick6	Light Box	Hi WoodBlock	Reg.Kick	
	100	TR909 Snare	Syn Swt Atk3	MuteTriangle	909 Ride	[M3]
	101	TR808 Snare	Laugh	OpenTriangle	Deep Tom	[M3]
	102	Mix Snare4	Office Phone	Castanet	Id Snare	
	103	Mix Snare5	Polish Kick	Whistle	Deep Tom	
	104	----	----	----	808 Kick	
	105	----	----	----	808 CHH	[M2]
	106	----	----	----	Analog Snr	
	107	----	----	----	808 OHH	[M2]
C8	108	----	----	----	Deep Tom	

---- : no sound

[M] : will not sound simultaneously with other percussion instruments of the same number

	PRST: 0001. Pop Kit 1	PRST: 0002. Rock Kit	PRST: 0003. Brush Jz Kit	PRST: 0004. HipHop Kit	PRST: 0005. R&B Kit
21	----	----	----	----	----
22	----	----	----	----	----
23	----	----	----	----	----
C1 24	----	----	----	----	----
25	----	----	----	----	----
26	----	----	----	----	----
27	----	----	----	----	----
28	----	----	----	----	----
29	----	----	----	----	----
30	----	----	----	----	----
31	Kick1	Kick1	Kick1	Analog Kick1	Mix Kick1
32	Snare Ghost1	Snare Ghost1	Snare Ghost	Analog Kick2	Mix Kick2
33	Kick2	Kick2	Kick2	Mix Kick1	Mix Kick3
34	Pedal Hihat	Pedal Hihat	Pedal Hi-hat	Mix Kick2	Mix Kick4
35	Kick3 [M1]	Power Kick1 [M1]	Jazz Kick 1 [M1]	Analog Kick3	Mix Kick5
C2 36	Kick4	Power Kick2	Jazz Kick 2	Mix Kick3	Mix Kick6
37	Side Stick	Side Stick	Side Stick	TR808 Rim1	Soft Stick
38	Snare1	Power Snare1	Brush Slap1	Mix Snare1	Short Snare1
39	Snare Ghost2	Snare Ghost2	Jz Brsh Swsh	Mix Clap1	Mix Stick
40	Snare2	Power Snare2	Brush Slap2	Mix Snare2	Short Snare2
41	Low Tom1	Low Tom1	BrushLowTom	Mix Snare3	Short Snare3
42	Cl Hihat1 [M1]	Cl Hihat1 [M1]	Brush CIHH1 [M1]	TR808 CIHH [M1]	Cl Hihat1 [M1]
43	Low Tom2	Low Tom2	BrushMidTom1	Mix Snare4	Short Snare4
44	Cl Hihat2 [M1]	Cl Hihat2 [M1]	Brush CIHH2 [M1]	Noise CIHH [M1]	Cl Hihat2 [M1]
45	Mid Tom1	Mid Tom1	BrushMidTom2	Mix Snare5	Mix Snare1
46	Op Hihat [M1]	Op Hihat [M1]	Brush OpHH [M1]	TR808 OpHH [M1]	Op Hihat [M1]
47	Mid Tom2	Mid Tom2	BrushMidTom2	Mix Snare6	Mix Snare2
C3 48	High Tom1	High Tom1	Brush HiTom	Syn Swt Atk1	Mix Snare3
49	CrashCymbal1	CrashCymbal1	CrashCymbal1	TR808 Cym1	TR808 Cym1
50	High Tom2	High Tom2	Brush HiTom	MG Attack	Mix Snare4
51	Ride Cymbal1	Ride Cymbal1	Ride Cymbal1	TR808 Cym2	TR808 Cym2
52	China Cymbal	China Cymbal	China Cymbal	China Cymbal	China Cymbal
	Ride Cymbal2	Ride Cymbal2	Ride Cymbal2	Rock Rd Edge	Rock Rd Edge
53	Tambourine	Tambourine	Tambourine	Tambourine1	Tambourine1
54	SplashCymbal	SplashCymbal	SplashCymbal	Mix Crash1	Mix Crash1
55	Cowbell	Cowbell	Cowbell	Mix Hat	Mix Hat
56	CrashCymbal2	CrashCymbal2	CrashCymbal2	Mix Crash2	Mix Crash2
57	Vibraslap	Vibraslap	Vibraslap	Syn Swt Atk2	Syn Swt Atk
58	Ride Cymbal3	Ride Cymbal3	Ride Cymbal3	TR808 Kick1	TR808 Kick1
C4 60	High Bongo1	High Bongo1	High Bongo	TR808 Kick2	TR808 Kick2
61	Low Bongo1	Low Bongo1	Low Bongo	TR808 Rim2	TR808 Rim
62	Conga Slap	Conga Slap	MtHigh Conga	TR808 Snare1	TR808 Snare1
63	OpenHi Conga	OpenHi Conga	OpHigh Conga	TR808 Clap1	TR808 Clap1
64	Low Conga1	Low Conga1	Low Conga	TR808 Snare2	TR808 Snare2
	High Timbale	High Timbale	High Timbale	TR808 Tom1	TR808 Tom1
65	Low Timbale	Low Timbale	Low Timbale	TR808 CIHH [M1]	TR808 CIHH [M1]
66	High Agogo	High Agogo	High Agogo	TR808 Tom2	TR808 Tom2
67	Low Agogo	Low Agogo	Low Agogo	Noise CIHH [M1]	Noise CIHH [M1]
68	Cabasa	Cabasa	Cabasa	TR808 Tom3	TR808 Tom3
69	Maracas	Maracas	Maracas	TR808 OpHH [M1]	TR808 OpHH [M1]
70	ShortWhistle [M2]	ShortWhistle [M2]	Jazz Kick 1 [M2]	TR808 Tom4	TR808 Tom4
C5 72	Long Whistle [M2]	Long Whistle [M2]	Jazz Kick 2	TR808 Tom5	TR808 Tom5
73	Short Guiro [M3]	Short Guiro [M3]	Side Stick	Scratch1	Scratch1
74	Long Guiro [M3]	Long Guiro [M3]	Jazz Snare1	TR808 Tom6	TR808 Tom6
75	Claves	Claves	Sft Snr Gst	Scratch2	Scratch2
76	Hi WoodBlock	Hi WoodBlock	Jazz Snare2	Hand Clap1	Hand Clap1
	LowWoodBlock	LowWoodBlock	Low Tom	Hand Clap2	Hand Clap2
77	Mute Cuica [M4]	Mute Cuica [M4]	Cl Hihat1 [M1]	TR808 Clap2	TR808 Clap2
78	Open Cuica [M4]	Open Cuica [M4]	Mid Tom1 [M1]	Cabasa	Cabasa
79	MuteTriangle [M5]	MuteTriangle [M5]	Cl Hihat2 [M1]	Shaker1	Shaker1
80	OpenTriangle [M5]	OpenTriangle [M5]	Mid Tom2 [M1]	Tambourine2	Tambourine2
81	Shaker	Shaker	Op Hihat [M1]	Shaker2	Shaker2
82	Castanet	Castanet	Mid Tom2	Castanet	Castanet
C6 84	High Bongo2	High Bongo2	High Tom	High Bongo	High Bongo
85	MtHigh Conga	MtHigh Conga	CrashCymbal1	MtHigh Conga	MtHigh Conga
86	Low Bongo2	Low Bongo2	High Tom	Low Bongo1	Low Bongo1
87	Low Bongo3	Low Bongo3	Ride Cymbal1	Low Bongo2	Low Bongo2
88	Low Conga2	Low Conga2	China Cymbal	Op Low Conga	Op Low Conga
	Low Tom3	Low Tom3	Low Tom3	Low Tom1	Low Tom1
89	Low Tom4	Low Tom4	Low Tom4	Low Tom2	Low Tom2
90	Mix Kick1	Mix Kick1	Claves	Mix Kick4	Mix Kick7
91	Mix Kick2	Mix Kick2	Hi WoodBlock	Mix Kick5	Mix Kick8
92	Mix Kick3	Mix Kick3	LowWoodBlock	TR909 Snare	Stream
93	Mix Kick4	Mix Kick4	MuteTriangle [M5]	Syn Burst Nz	Bubble
94	Mix Nz1	Mix Nz1	OpenTriangle [M5]	Digi Breath	Train
C7 96	Mix Nz2	Mix Nz2	Shaker	Mix Breath	Wind Chime
97	Mix Nz3	Mix Nz3	Castanet	Wide Shaker	Syn Back Nz1
98	Wind Chime	Wind Chime	Wind Chime	JD Tuba Slap	Syn Back Nz2
99	Hand Clap1	Hand Clap1	Hand Clap 1	Hand Clap3	Hand Clap3
100	Hand Clap2	Hand Clap2	Hand Clap 2	Hand Clap4	Hand Clap4
101	----	----	----	Door Creak	----
102	----	----	----	Vint.Phone	----
103	----	----	----	Polish Kick	----
104	----	----	----	----	----
105	----	----	----	----	----
106	----	----	----	----	----
107	----	----	----	----	----
C8 108	----	----	----	----	----

---- : no sound

[M] : will not sound simultaneously with other percussion instruments of the same number

Performance List

	PRST: 0006. Dance Kit 1	PRST: 0007. Dance Kit 2	PRST: 0008. Dance Kit 3	PRST: 0009. Pop Kit 2	PRST: 0010. Dance Kit 4
21	----	----	----	----	----
22	----	----	----	----	----
23	----	----	----	----	----
C1	----	----	----	----	----
24	----	----	----	----	----
25	----	----	----	----	----
26	----	----	----	----	----
27	----	----	----	----	----
28	TR808 Kick	SH32 Kick1	TR909 Kick1	----	TR808 Kick
	Mix Kick1	TR909 Kick1	SH32 Kick1	----	Mix Kick1
29	Mix Snare1	AnalogSnare1	Snare Ghost1	----	Mix Snare1
30	Mix Kick2	Analog Kick1	Analog Kick	Kick1	Mix Kick2
31	Mix Snare2	TR808 Snare	TR909 Snare1	Snare Ghost1	Mix Snare2
32	Mix Kick3	SH32 Kick2	SH32 Kick2	Kick2	Mix Kick3
33	Thin CIHH	Pedal Hihat	Pedal Hihat	Pedal Hihat	Thin CIHH
34	Mix Kick4	TR909 Kick2	TR909 Kick2	Kick3	Mix Kick4
C2	----	----	----	----	----
36	Mix Kick5	Analog Kick2	TR909 Kick3	Kick4	Mix Kick5
37	Mix Rim1	Synth Rim	TR808 Rim1	Side Stick	Mix Rim1
38	Analog Snare	TR909 Snare	TR909 Snare2	Snare1	Mix Snare3
39	TR808 Clap	TR808 Clap1	TR808 Clap	Snare Ghost2	TR808 Clap
40	Mix Snare3	DistNz Snare	TR909 Snare3	Snare2	Mix Snare4
	Mix Tom1	Deep Tom1	TR808 Tom1	Low Tom1	Mix Tom1
41	Mix CIHH1	TR808 CIHH	CI Hihat1	CI Hihat1	Mix CIHH1
42	Mix Tom2	Deep Tom1	TR808 Tom2	Low Tom2	Mix Tom2
43	Mix CIHH2	TR606 OpHH	CI Hihat2	CI Hihat2	Mix CIHH2
44	Mix Tom3	Deep Tom2	TR808 Tom3	Mid Tom1	Mix Tom3
45	Op Hihat	TR808 Cym1	Op Hihat1	Op Hihat	Op Hihat
46	Mix Tom3	Deep Tom2	TR808 Tom4	Mid Tom2	Mix Tom3
C3	----	----	----	----	----
48	Mix Tom4	Deep Tom3	TR808 Tom5	High Tom1	Mix Tom4
49	Crash Cymbal	TR808 OpHH	CrashCymbal1	CrashCymbal1	Crash Cymbal
	Mix Tom4	Deep Tom3	TR808 Tom6	High Tom2	Mix Tom4
50	Rock Rd Edge	Wide Syn Cym	Ride Cymbal1	Ride Cymbal1	Rock Rd Edge
51	China Cymbal	TR808 Cym2	Rock Chash	China Cymbal	China Cymbal
52	Ride Cymbal	China Cym1	Ride Cup	Ride Cymbal2	Ride Cymbal
53	Tambourine	Castanet	Tambourine1	Tambourine	Tambourine
54	Rock Crash	TR808 Cym3	Syn Swt Atk1	SplashCymbal	Rock Crash
55	Cowbell	Syn Cowbell	Agogo Noise	Cowbell	Cowbell
56	Concert Cym	China Cym2	MG Zap1	CrashCymbal2	Concert Cym
57	Vibraslap	Syn Swt Atk1	Syn Swt Atk2	Vibraslap	Vibraslap
58	TR808 Cym	TR909 Kick3	TR909 Kick4	Ride Cymbal3	TR808 Cym
C4	----	----	----	----	----
60	Bongo1	Analog Kick3	SH32 Kick3	High Bongo1	Bongo1
61	Bongo2	Syn Stick	TR808 Rim2	Low Bongo1	Bongo2
62	Bongo&Conga1	AnalogSnare2	TR808 Snare1	Conga Slap	Bongo&Conga1
63	Conga	TR808 Clap2	TR808 Clap1	OpenHi Conga	Conga
64	Bongo&Conga2	AnalogSnare3	Analog Snare	Low Conga1	Bongo&Conga2
	TR808 Conga	Shaker1	Mid Tom1	High Timbale	TR808 Conga
65	Maracas	Syn CIHH1	Noise CIHH	Low Timbale	Maracas
66	Shaker	Shaker2	Mid Tom2	High Agogo	Shaker
67	Triangle1	Syn CIHH2	CI Hihat3	Low Agogo	Triangle1
68	Cabasa	Atmosphere1	Mid Tom3	Cabasa	Cabasa
69	Guiro	Syn OpHH	Op Hihat2	Maracas	Guiro 1
70	Street OpHH	Atmosphere2	Mid Tom4	ShortWhistle	Street OpHH
C5	----	----	----	----	----
72	Scratch	Atmosphere3	Mid Tom5	Long Whistle	Scratch
73	Mix Atk1	TR808 Cym4	Rock Crash2	Short Guiro	Mix Atk1
74	MG Zap	Atmosphere4	Mid Tom6	Long Guiro	MG Zap
75	Syn Swt Atk1	Mix Ride	SplashCymbal	Claves	Syn Swt Atk1
76	Syn Swt Atk2	China Cym3	Rock Crash3	Hi WoodBlock	Syn Swt Atk2
	Cuica Low	Rock Rd Edge	Rock Rd Edge	LowWoodBlock	Cuica Low
77	Triangle2	Syn Slap	Tambourine2	Mute Cuica	Triangle2
78	Triangle3	MG Zap1	Syn Swt Atk3	Open Cuica	Triangle3
79	Triangle4	SynVox Noise	Cowbell1	MuteTriangle	Triangle4
80	Mix Hit1	MG Zap2	Syn Swt Atk4	OpenTriangle	Guiro 2
81	Mix Hit2	Syn Swt Atk2	Cowbell2	Shaker	Mix Hit2
82	Mix Hit3	MG Zap3	MG Zap2	Castanet	Mix Hit3
C6	----	----	----	----	----
84	Wind Chime	808 Maracas	Low Bongo	High Bongo2	Wind Chime
85	Timpani Roll	TR808 Claves	MtHigh Conga	MtHigh Conga	Timpani Roll
86	Crotale	MuteTriangle	Conga Slap	Low Bongo2	Crotale
87	R8 Click	OpenTriangle	OpHigh Conga	Low Bongo3	R8 Click
88	Metro Bell	Mix Hit	Op Low Conga	Low Conga2	Metro Bell
	DR202 Beep 1	Scratch	High Timbale	Low Tom3	MC500 Beep 1
89	DR202 Beep 2	Easy Gtr	Low Timbale	Low Tom4	MC500 Beep 2
90	Sweep Down1	Syn Bel Atk	High Agogo	Mix Kick1	Sweep Down1
91	Sweep Up	MG Attack	Low Agogo	Mix Kick2	Sweep Up
92	Sweep Down2	SynSnareRoll	Cabasa	Mix Kick3	Sweep Down2
93	Light Wood	Syn Burst Nz	Maracas	Mix Kick4	Light Wood
94	Laser	White Noise	Short Guiro	Mix Nz1	Laser
C7	----	----	----	----	----
96	Low Atk	Polishing Nz	Long Guiro	Mix Nz2	Low Atk
97	Analog Kick	Long Guiro	Claves	Mix Nz3	Analog Kick
98	Old Kick	Light Wood	LowWoodBlock	Wind Chime	Old Kick
99	Mix Kick6	Light Box	Hi WoodBlock	Hand Clap1	Mix Kick6
100	TR909 Snare	Syn Swt Atk3	MuteTriangle	Hand Clap2	TR909 Snare
101	TR808 Snare	Laugh	OpenTriangle	----	TR808 Snare
102	Mix Snare4	Office Phone	Castanet	----	Mix Snare5
103	Mix Snare5	Polish Kick	Whistle	----	Mix Snare6
104	----	----	----	----	----
105	----	----	----	----	----
106	----	----	----	----	----
107	----	----	----	----	----
C8	108	----	----	----	----

---- : no sound

[M] : will not sound simultaneously with other percussion instruments of the same number

	PRST: 0011. Ambi Pop 1	PRST: 0012. Ambi Rock	PRST: 0013. Ambi BrushJz	PRST: 0014. Ambi HipHop	PRST: 0015. Ambi R&B
21	----	----	----	----	----
22	----	----	----	----	----
23	----	----	----	----	----
C1 24	----	----	----	----	----
25	----	----	----	----	----
26	----	----	----	----	----
27	----	----	----	----	----
28	----	----	----	----	----
29	----	----	----	----	----
30	----	----	----	----	----
31	Kick1	Kick1	Kick1	Analog Kick1	Mix Kick1
32	Snare Ghost1	Snare Ghost1	Snare Ghost	Analog Kick2	Mix Kick2
33	Kick2	Kick2	Kick2	Mix Kick1	Mix Kick3
34	Pedal Hihat	Pedal Hihat	Pedal Hi-hat	Mix Kick2	Mix Kick4
35	Kick3 [M1]	Power Kick1 [M1]	Jazz Kick 1 [M1]	Analog Kick3	Mix Kick5
C2 36	Kick4	Power Kick2	Jazz Kick 2	Mix Kick3	Mix Kick6
37	Side Stick	Side Stick	Side Stick	TR808 Rim1	Soft Stick
38	Snare1	Power Snare1	Brush Slap1	Mix Snare1	Short Snare1
39	Snare Ghost2	Snare Ghost2	Jz Brsh Swsh	Mix Clap1	Mix Stick
40	Snare2	Power Snare2	Brush Slap2	Mix Snare2	Short Snare2
41	Low Tom1	Low Tom1	BrushLowTom	Mix Snare3	Short Snare3
42	Cl Hihat1 [M1]	Cl Hihat1 [M1]	Brush CIHH1 [M1]	TR808 CIHH [M1]	Cl Hihat1 [M1]
43	Low Tom2	Low Tom2	BrushMidTom1	Mix Snare4	Short Snare4
44	Cl Hihat2 [M1]	Cl Hihat2 [M1]	Brush CIHH2 [M1]	Noise CIHH [M1]	Cl Hihat2 [M1]
45	Mid Tom1	Mid Tom1	BrushMidTom2	Mix Snare5	Mix Snare1
46	Op Hihat [M1]	Op Hihat [M1]	Brush OpHH [M1]	TR808 OpHH [M1]	Op Hihat [M1]
47	Mid Tom2	Mid Tom2	BrushMidTom2	Mix Snare6	Mix Snare2
C3 48	High Tom1	High Tom1	Brush HiTom	Syn Swt Atk1	Mix Snare3
49	CrashCymbal1	CrashCymbal1	CrashCymbal1	TR808 Cym1	TR808 Cym1
50	High Tom2	High Tom2	Brush HiTom	MG Attack	Mix Snare4
51	Ride Cymbal1	Ride Cymbal1	Ride Cymbal1	TR808 Cym2	TR808 Cym2
52	China Cymbal	China Cymbal	China Cymbal	China Cymbal	China Cymbal
	Ride Cymbal2	Ride Cymbal2	Ride Cymbal2	Rock Rd Edge	Rock Rd Edge
53	Tambourine	Tambourine	Tambourine	Tambourine1	Tambourine1
54	SplashCymbal	SplashCymbal	SplashCymbal	Mix Crash1	Mix Crash1
55	Cowbell	Cowbell	Cowbell	Mix Hat	Mix Hat
56	CrashCymbal2	CrashCymbal2	CrashCymbal2	Mix Crash2	Mix Crash2
57	Vibraslap	Vibraslap	Vibraslap	Syn Swt Atk2	Syn Swt Atk
58	Ride Cymbal3	Ride Cymbal3	Ride Cymbal3	TR808 Kick1	TR808 Kick1
C4 60	High Bongo1	High Bongo1	High Bongo	TR808 Kick2	TR808 Kick2
61	Low Bongo1	Low Bongo1	Low Bongo	TR808 Rim2	TR808 Rim
62	Conga Slap	Conga Slap	MtHigh Conga	TR808 Snare1	TR808 Snare1
63	OpenHi Conga	OpenHi Conga	OpHigh Conga	TR808 Clap1	TR808 Clap1
64	Low Conga1	Low Conga1	Low Conga	TR808 Snare2	TR808 Snare2
	High Timbale	High Timbale	High Timbale	TR808 Tom1	TR808 Tom1
65	Low Timbale	Low Timbale	Low Timbale	TR808 CIHH [M1]	TR808 CIHH [M1]
66	High Agogo	High Agogo	High Agogo	TR808 Tom2	TR808 Tom2
67	Low Agogo	Low Agogo	Low Agogo	Noise CIHH [M1]	Noise CIHH [M1]
68	Cabasa	Cabasa	Cabasa	TR808 Tom3	TR808 Tom3
69	Maracas	Maracas	Maracas	TR808 OpHH [M1]	TR808 OpHH [M1]
70	ShortWhistle [M2]	ShortWhistle [M2]	Jazz Kick 1 [M2]	TR808 Tom4	TR808 Tom4
C5 72	Long Whistle [M2]	Long Whistle [M2]	Jazz Kick 2	TR808 Tom5	TR808 Tom5
73	Short Guiro [M3]	Short Guiro [M3]	Side Stick	Scratch1	Scratch1
74	Long Guiro [M3]	Long Guiro [M3]	Jazz Snare1	TR808 Tom6	TR808 Tom6
75	Claves	Claves	Sft Snr Gst	Scratch2	Scratch2
76	Hi WoodBlock	Hi WoodBlock	Jazz Snare2	Hand Clap1	Hand Clap1
	LowWoodBlock	LowWoodBlock	Low Tom	Hand Clap2	Hand Clap2
77	Mute Cuica [M4]	Mute Cuica [M4]	Cl Hihat1 [M1]	TR808 Clap2	TR808 Clap2
78	Open Cuica [M4]	Open Cuica [M4]	Mid Tom1 [M1]	Cabasa	Cabasa
79	MuteTriangle [M5]	MuteTriangle [M5]	Cl Hihat2 [M1]	Shaker1	Shaker1
80	OpenTriangle [M5]	OpenTriangle [M5]	Mid Tom2 [M1]	Tambourine2	Tambourine2
81	Shaker	Shaker	Op Hihat [M1]	Shaker2	Shaker2
82	Castanet	Castanet	Mid Tom2	Castanet	Castanet
C6 84	High Bongo2	High Bongo2	High Tom	High Bongo	High Bongo
85	MtHigh Conga	MtHigh Conga	CrashCymbal1	MtHigh Conga	MtHigh Conga
86	Low Bongo2	Low Bongo2	High Tom	Low Bongo1	Low Bongo1
87	Low Bongo3	Low Bongo3	Ride Cymbal1	Low Bongo2	Low Bongo2
88	Low Conga2	Low Conga2	China Cymbal	Op Low Conga	Op Low Conga
	Low Tom3	Low Tom3	Low Tom3	Low Tom1	Low Tom1
89	Low Tom4	Low Tom4	Low Tom4	Low Tom2	Low Tom2
90	Mix Kick1	Mix Kick1	Claves	Mix Kick4	Mix Kick7
91	Mix Kick2	Mix Kick2	Hi WoodBlock	Mix Kick5	Mix Kick8
92	Mix Kick3	Mix Kick3	LowWoodBlock	TR909 Snare	Stream
93	Mix Kick4	Mix Kick4	MuteTriangle [M5]	Syn Burst Nz	Bubble
94	Mix Nz1	Mix Nz1	OpenTriangle [M5]	Digi Breath	Train
C7 96	Mix Nz2	Mix Nz2	Shaker	Mix Breath	Wind Chime
97	Mix Nz3	Mix Nz3	Castanet	Wide Shaker	Syn Back Nz1
98	Wind Chime	Wind Chime	Wind Chime	JD Tuba Slap	Syn Back Nz2
99	Hand Clap1	Hand Clap1	Hand Clap 1	Hand Clap3	Hand Clap3
100	Hand Clap2	Hand Clap2	Hand Clap 2	Hand Clap4	Hand Clap4
101	----	----	----	Door Creak	----
102	----	----	----	Vint.Phone	----
103	----	----	----	Polish Kick	----
104	----	----	----	----	----
105	----	----	----	----	----
106	----	----	----	----	----
107	----	----	----	----	----
C8 108	----	----	----	----	----

---- : no sound

[M] : will not sound simultaneously with other percussion instruments of the same number

Performance List

	PRST: 0016. Ambi Dance 1	PRST: 0017. Ambi Dance 2	PRST: 0018. Ambi Dance 3	PRST: 0019. Ambi Pop 2	PRST: 0020. Ambi Dance 4
21	----	----	----	----	----
22	----	----	----	----	----
23	----	----	----	----	----
C1	----	----	----	----	----
24	----	----	----	----	----
25	----	----	----	----	----
26	----	----	----	----	----
27	----	----	----	----	----
28	TR808 Kick	SH32 Kick1	TR909 Kick1	----	TR808 Kick
	Mix Kick1	TR909 Kick1	SH32 Kick1	----	Mix Kick1
29	Mix Snare1	AnalogSnare1	Snare Ghost1	----	Mix Snare1
30	Mix Kick2	Analog Kick1	Analog Kick	Kick1	Mix Kick2
31	Mix Snare2	TR808 Snare	TR909 Snare1	Snare Ghost1	Mix Snare2
32	Mix Kick3	SH32 Kick2	SH32 Kick2	Kick2	Mix Kick3
33	Thin CIHH	Pedal Hihat	Pedal Hihat	Pedal Hihat	Thin CIHH
34	Mix Kick4	TR909 Kick2	TR909 Kick2	Kick3	Mix Kick4
C2	----	----	----	----	----
36	Mix Kick5	Analog Kick2	TR909 Kick3	Kick4	Mix Kick5
37	Mix Rim1	Synth Rim	TR808 Rim1	Side Stick	Mix Rim1
38	Analog Snare	TR909 Snare	TR909 Snare2	Snare1	Mix Snare3
39	TR808 Clap	TR808 Clap1	TR808 Clap	Snare Ghost2	TR808 Clap
40	Mix Snare3	DistNz Snare	TR909 Snare3	Snare2	Mix Snare4
	Mix Tom1	Deep Tom1	TR808 Tom1	Low Tom1	Mix Tom1
41	Mix CIHH1	TR808 CIHH	CI Hihat1	CI Hihat1	Mix CIHH1
42	Mix Tom2	Deep Tom1	TR808 Tom2	Low Tom2	Mix Tom2
43	Mix CIHH2	TR606 OpHH	CI Hihat2	CI Hihat2	Mix CIHH2
44	Mix Tom3	Deep Tom2	TR808 Tom3	Mid Tom1	Mix Tom3
45	Op Hihat	TR808 Cym1	Op Hihat1	Op Hihat	Op Hihat
46	Mix Tom3	Deep Tom2	TR808 Tom4	Mid Tom2	Mix Tom3
C3	----	----	----	----	----
48	Mix Tom4	Deep Tom3	TR808 Tom5	High Tom1	Mix Tom4
49	Crash Cymbal	TR808 OpHH	CrashCymbal1	CrashCymbal1	Crash Cymbal
	Mix Tom4	Deep Tom3	TR808 Tom6	High Tom2	Mix Tom4
50	Rock Rd Edge	Wide Syn Cym	Ride Cymbal1	Ride Cymbal1	Rock Rd Edge
51	China Cymbal	TR808 Cym2	Rock Chash	China Cymbal	China Cymbal
52	Ride Cymbal	China Cym1	Ride Cup	Ride Cymbal2	Ride Cymbal
53	Tambourine	Castanet	Tambourine1	Tambourine	Tambourine
54	Rock Crash	TR808 Cym3	Syn Swt Atk1	SplashCymbal	Rock Crash
55	Cowbell	Syn Cowbell	Agogo Noise	Cowbell	Cowbell
56	Concert Cym	China Cym2	MG Zap1	CrashCymbal2	Concert Cym
57	Vibraslap	Syn Swt Atk1	Syn Swt Atk2	Vibraslap	Vibraslap
58	TR808 Cym	TR909 Kick3	TR909 Kick4	Ride Cymbal3	TR808 Cym
C4	----	----	----	----	----
60	Bongo1	Analog Kick3	SH32 Kick3	High Bongo1	Bongo1
61	Bongo2	Syn Stick	TR808 Rim2	Low Bongo1	Bongo2
62	Bongo&Conga1	AnalogSnare2	TR808 Snare1	Conga Slap	Bongo&Conga1
63	Conga	TR808 Clap2	TR808 Clap1	OpenHi Conga	Conga
64	Bongo&Conga2	AnalogSnare3	Analog Snare	Low Conga1	Bongo&Conga2
	TR808 Conga	Shaker1	Mid Tom1	High Timbale	TR808 Conga
65	Maracas	Syn CIHH1	Noise CIHH	Low Timbale	Maracas
66	Shaker	Shaker2	Mid Tom2	High Agogo	Shaker
67	Triangle1	Syn CIHH2	CI Hihat3	Low Agogo	Triangle1
68	Cabasa	Atmosphere1	Mid Tom3	Cabasa	Cabasa
69	Guiro	Syn OpHH	Op Hihat2	Maracas	Guiro 1
70	Street OpHH	Atmosphere2	Mid Tom4	ShortWhistle	Street OpHH
C5	----	----	----	----	----
72	Scratch	Atmosphere3	Mid Tom5	Long Whistle	Scratch
73	Mix Atk1	TR808 Cym4	Rock Crash2	Short Guiro	Mix Atk1
74	MG Zap	Atmosphere4	Mid Tom6	Long Guiro	MG Zap
75	Syn Swt Atk1	Mix Ride	SplashCymbal	Claves	Syn Swt Atk1
76	Syn Swt Atk2	China Cym3	Rock Crash3	Hi WoodBlock	Syn Swt Atk2
	Cuica Low	Rock Rd Edge	Rock Rd Edge	LowWoodBlock	Cuica Low
77	Triangle2	Syn Slap	Tambourine2	Mute Cuica	Triangle2
78	Triangle3	MG Zap1	Syn Swt Atk3	Open Cuica	Triangle3
79	Triangle4	SynVox Noise	Cowbell1	MuteTriangle	Triangle4
80	Mix Hit1	MG Zap2	Syn Swt Atk4	OpenTriangle	Guiro 2
81	Mix Hit2	Syn Swt Atk2	Cowbell2	Shaker	Mix Hit2
82	Mix Hit3	MG Zap3	MG Zap2	Castanet	Mix Hit3
C6	----	----	----	----	----
84	Wind Chime	808 Maracas	Low Bongo	High Bongo2	Wind Chime
85	Timpani Roll	TR808 Claves	MtHigh Conga	MtHigh Conga	Timpani Roll
86	Crotale	MuteTriangle	Conga Slap	Low Bongo2	Crotale
87	R8 Click	OpenTriangle	OpHigh Conga	Low Bongo3	R8 Click
88	Metro Bell	Mix Hit	Op Low Conga	Low Conga2	Metro Bell
	DR202 Beep 1	Scratch	High Timbale	Low Tom3	MC500 Beep 1
89	DR202 Beep 2	Easy Gtr	Low Timbale	Low Tom4	MC500 Beep 2
90	Sweep Down1	Syn Bel Atk	High Agogo	Mix Kick1	Sweep Down1
91	Sweep Up	MG Attack	Low Agogo	Mix Kick2	Sweep Up
92	Sweep Down2	SynSnareRoll	Cabasa	Mix Kick3	Sweep Down2
93	Light Wood	Syn Burst Nz	Maracas	Mix Kick4	Light Wood
94	Laser	White Noise	Short Guiro	Mix Nz1	Laser
C7	----	----	----	----	----
96	Low Atk	Polishing Nz	Long Guiro	Mix Nz2	Low Atk
97	Analog Kick	Long Guiro	Claves	Mix Nz3	Analog Kick
98	Old Kick	Light Wood	LowWoodBlock	Wind Chime	Old Kick
99	Mix Kick6	Light Box	Hi WoodBlock	Hand Clap1	Mix Kick6
100	TR909 Snare	Syn Swt Atk3	MuteTriangle	Hand Clap2	TR909 Snare
101	TR808 Snare	Laugh	OpenTriangle	----	TR808 Snare
102	Mix Snare4	Office Phone	Castanet	----	Mix Snare5
103	Mix Snare5	Polish Kick	Whistle	----	Mix Snare6
104	----	----	----	----	----
105	----	----	----	----	----
106	----	----	----	----	----
107	----	----	----	----	----
C8	108	----	----	----	----

---- : no sound

[M] : will not sound simultaneously with other percussion instruments of the same number

	PRST: 0021. Latin Menu	GM: 0001. GM2 STANDARD	GM: 0002. GM2 ROOM	GM: 0003. GM2 POWER	GM: 0004. GM2 ELECTRIC
C1 21	----	----	----	----	----
22	----	----	----	----	----
23	----	----	----	----	----
24	----	----	----	----	----
25	----	----	----	----	----
26	----	----	----	----	----
27	----	----	----	----	----
28	High Q	High Q	High Q	High Q	High Q
29	Slap	Slap	Slap	Slap	Slap
30	Scratch Push [M7]	Scratch Push [M7]	Scratch Push [M7]	Scratch Push [M7]	Scratch Push [M7]
31	Scratch Pull [M7]	Scratch Pull [M7]	Scratch Pull [M7]	Scratch Pull [M7]	Scratch Pull [M7]
32	Sticks	Sticks	Sticks	Sticks	Sticks
33	Square Click	Square Click	Square Click	Square Click	Square Click
34	Metron Click	Metron Click	Metron Click	Metron Click	Metron Click
35	Metron Bell	Metron Bell	Metron Bell	Metron Bell	Metron Bell
36	Kick Drum 2	Kick Drum 2	Kick Drum 2	Power Kick 2	Kick Drum 2
C2 37	Agogo 2 Hi	Kick Drum 1	Kick Drum 1	Power Kick 1	Elec.Kick 1
38	Agogo 2 Lo	Side Stick	Side Stick	Side Stick	Side Stick
39	Agogo 3 Hi	Aco.Snare	Aco.Snare	PowerSnareDr	E.SnareDrum1
40	Agogo 3 Lo	Hand Clap	Hand Clap	Hand Clap	Hand Clap
41	ApitoHiShort	Elec.Snare	Elec.Snare	Elec.Snare	E.SnareDrum2
42	ApitoLoShort	Room LowTom 2	Room LowTom2	PowerLowTom2	E.Low Tom 2
43	Berimbau Dn	ClosedHi-hat [M1]	ClosedHi-hat [M1]	ClosedHi-hat [M1]	ClosedHi-hat [M1]
44	Berimbau Mut	Room LowTom 1	Room LowTom1	PowerLowTom1	E.Low Tom 1
45	Berimbau Opn	Pedal Hi-hat [M1]	Pedal Hi-hat [M1]	Pedal Hi-hat [M1]	Pedal Hi-hat [M1]
46	Berimbau Up	Mid Tom 2	Room MidTom2	PowerMidTom2	E.Mid Tom 2
47	Bongo 1 Hi	Open Hi-hat [M1]	Open Hi-hat [M1]	Open Hi-hat [M1]	Open Hi-hat [M1]
48	Bongo 1 Lo	Mid Tom 1	Room MidTom1	PowerMidTom1	E.Mid Tom 1
C3 49	Bongo 2 Hi	High Tom 2	Room Hi Tom2	Power HiTom2	E.Hi Tom 2
50	Bongo 2 Lo	CrashCymbal1	CrashCymbal1	CrashCymbal1	CrashCymbal1
51	Bongo Hi Hrd	High Tom 1	Room Hi Tom1	Power HiTom1	E.Hi Tom 1
52	Bongo HiOp f	Ride Cymbal1	Ride Cymbal1	Ride Cymbal1	Ride Cymbal1
53	Bongo Lo Hrd	China Cymbal	China Cymbal	China Cymbal	Reverse Cym.
54	Bongo Lo Sft	Ride Bell	Ride Bell	Ride Bell	Ride Bell
55	Bongo LoOp f	Tambourine	Tambourine	Tambourine	Tambourine
56	Bongo LoOpmf	SplashCymbal	SplashCymbal	SplashCymbal	SplashCymbal
57	Bongo LoSlap	Cowbell	Cowbell	Cowbell	Cowbell
58	BongoBell Mt	CrashCymbal2	CrashCymbal2	CrashCymbal2	CrashCymbal2
59	BongoBell Op	Vibra-slap	Vibra-slap	Vibra-slap	Vibra-slap
60	BongoHiSlap1	Ride Cymbal2	Ride Cymbal2	Ride Cymbal2	Ride Cymbal2
C4 61	BongoHiSlap2	High Bongo	High Bongo	High Bongo	High Bongo
62	Cabasa Roll	Low Bongo	Low Bongo	Low Bongo	Low Bongo
63	Caixa Mute	MuteHi Conga	MuteHi Conga	MuteHi Conga	MuteHi Conga
64	Caixa Mute2	OpenHi Conga	OpenHi Conga	OpenHi Conga	OpenHi Conga
65	Caixa Open1	Low Conga	Low Conga	Low Conga	Low Conga
66	Caixa Open2	High Timbale	High Timbale	High Timbale	High Timbale
67	Caixa Open3	Low Timbale	Low Timbale	Low Timbale	Low Timbale
68	Caixa Rim	High Agogo	High Agogo	High Agogo	High Agogo
69	Caixa Roll	Low Agogo	Low Agogo	Low Agogo	Low Agogo
70	Caixa Roll2	Cabasa	Cabasa	Cabasa	Cabasa
71	Cajon Hi	Maracas	Maracas	Maracas	Maracas
72	Cajon Lo	ShortWhistle [M2]	ShortWhistle [M2]	ShortWhistle [M2]	ShortWhistle [M2]
C5 73	Cajon Rol Hi	Long Whistle [M2]	Long Whistle [M2]	Long Whistle [M2]	Long Whistle [M2]
74	Cajon Rol Lo	Short Guiro [M3]	Short Guiro [M3]	Short Guiro [M3]	Short Guiro [M3]
75	Caxixi	Long Guiro [M3]	Long Guiro [M3]	Long Guiro [M3]	Long Guiro [M3]
76	Chekere 1	Claves	Claves	Claves	Claves
77	Chekere 2	Hi WoodBlock	Hi WoodBlock	Hi WoodBlock	Hi WoodBlock
78	Chekere 3	LowWoodBlock	LowWoodBlock	LowWoodBlock	LowWoodBlock
79	Clave!	Mute Cuica [M4]	Mute Cuica [M4]	Mute Cuica [M4]	Mute Cuica [M4]
80	Claves Lo 2	Open Cuica [M4]	Open Cuica [M4]	Open Cuica [M4]	Open Cuica [M4]
81	Conga Hi Mt	MuteTriangle [M5]	MuteTriangle [M5]	MuteTriangle [M5]	MuteTriangle [M5]
82	Conga Hi Op	OpenTriangle [M5]	OpenTriangle [M5]	OpenTriangle [M5]	OpenTriangle [M5]
83	Conga Link	Shaker	Shaker	Shaker	Shaker
84	Conga Lo Mt	Jingle Bell	Jingle Bell	Jingle Bell	Jingle Bell
C6 85	Conga Roll	Bell Tree	Bell Tree	Bell Tree	Bell Tree
86	Conga Slap	Castanets	Castanets	Castanets	Castanets
87	Conga Thumb	Mute Surdo [M6]	Mute Surdo [M6]	Mute Surdo [M6]	Mute Surdo [M6]
88	CongaLoOp f	Open Surdo [M6]	Open Surdo [M6]	Open Surdo [M6]	Open Surdo [M6]
89	CongaLoOp mf	----	----	----	----
90	Cowbell 1	----	----	----	----
91	Cowbell 2	----	----	----	----
92	Cowbell 3	----	----	----	----
93	Cowbell Mt 1	----	----	----	----
94	Cowbell Mt 2	----	----	----	----
95	Cowbell Op 1	----	----	----	----
96	Cowbell Op 2	----	----	----	----
C7 97	----	----	----	----	----
98	----	----	----	----	----
99	----	----	----	----	----
100	----	----	----	----	----
101	----	----	----	----	----
102	----	----	----	----	----
103	----	----	----	----	----
104	----	----	----	----	----
105	----	----	----	----	----
106	----	----	----	----	----
107	----	----	----	----	----
C8 108	----	----	----	----	----

----: no sound

[M]: will not sound simultaneously with other percussion instruments of the same number

Performance List

	GM: 0005. GM2 ANALOG	GM: 0006. GM2 JAZZ	GM: 0007. GM2 BRUSH	GM: 0008. GM2 ORCHSTRA	GM: 0009. GM2 SFX
21	----	----	----	----	----
22	----	----	----	----	----
23	----	----	----	----	----
C1	----	----	----	----	----
24	----	----	----	----	----
25	----	----	----	----	----
26	----	----	----	----	----
27	High Q	High Q	High Q	ClosedHi-hat [M1]	----
28	Slap	Slap	Slap	Pedal Hi-hat [M1]	----
29	Scratch Push [M7]	Scratch Push [M7]	Scratch Push [M7]	Open Hi-hat [M1]	----
30	Scratch Pull [M7]	Scratch Pull [M7]	Scratch Pull [M7]	Ride Cymbal1	----
31	Sticks	Sticks	Sticks	Sticks	----
32	Square Click	Square Click	Square Click	Square Click	----
33	Metron Click	Metron Click	Metron Click	Metron Click	----
34	Metron Bell	Metron Bell	Metron Bell	Metron Bell	----
35	Kick Drum 2	Jazz Kick 2	Jazz Kick 2	Concert BD 2	----
C2	----	----	----	----	----
36	Ana.Kick 1	Jazz Kick 1	Jazz Kick 1	Concert BD 1	----
37	Ana.Rim Sho	Side Stick	Side Stick	Side Stick	----
38	Ana.Snare 1	Aco.Snare	Brush Tap	Concert SD	----
39	Hand Clap	Hand Clap	Brush Slap	Castanets	High Q
40	Elec.Snare	Elec.Snare	Brush Swirl	Concert SD	Slap
41	Ana.Low Tom2	Low Tom 2	BrushLowTom2	Timpani F	Scratch Push [M7]
42	Ana.ClosedHH [M1]	ClosedHi-hat [M1]	ClosedHi-hat [M1]	Timpani F#	Scratch Pull [M7]
43	Ana.Low Tom1	Low Tom 1	BrushLowTom1	Timpani G	Sticks
44	Ana.ClosedHH [M1]	Pedal Hi-hat [M1]	Pedal Hi-hat [M1]	Timpani G#	Square Click
45	Ana.Mid Tom2	Mid Tom 2	BrushMidTom2	Timpani A	Metron Click
46	Ana.Open HH [M1]	Open Hi-hat [M1]	Open Hi-hat [M1]	Timpani A#	Metron Bell
47	Ana.Mid Tom1	Mid Tom 1	BrushMidTom1	Timpani B	GtFret Noise
C3	----	----	----	----	----
48	Ana.Hi Tom2	High Tom 2	Brush HiTom2	Timpani c	Cut Noise Up
49	Ana.Cymbal	CrashCymbal1	CrashCymbal1	Timpani c#	Cut Noise Dw
50	Ana.Hi Tom1	High Tom 1	Brush HiTom1	Timpani d	Slap_St.Bass
51	Ride Cymbal1	Ride Cymbal1	Ride Cymbal1	Timpani d#	Fl.Key Click
52	China Cymbal	China Cymbal	China Cymbal	Timpani e	Laughing
	Ride Bell	Ride Bell	Ride Bell	Timpani f	Scream
53	Tambourine	Tambourine	Tambourine	Tambourine	Punch
54	SplashCymbal	SplashCymbal	SplashCymbal	SplashCymbal	Heart Beat
55	Ana.Cowbell	Cowbell	Cowbell	Cowbell	Footsteps 1
56	CrashCymbal2	CrashCymbal2	CrashCymbal2	Concert Cym2	Footsteps 2
57	Vibra-slap	Vibra-slap	Vibra-slap	Vibra-slap	Applause
58	Ride Cymbal2	Ride Cymbal2	Ride Cymbal2	Concert Cym1	Door Creak
59	----	----	----	----	----
C4	----	----	----	----	----
60	High Bongo	High Bongo	High Bongo	High Bongo	Door
61	Low Bongo	Low Bongo	Low Bongo	Low Bongo	Scratch
62	Ana.Hi Conga	MuteHi Conga	MuteHi Conga	MuteHi Conga	Wind Chimes
63	Ana.MidConga	OpenHi Conga	OpenHi Conga	OpenHi Conga	Car-Engine
64	Ana.LowConga	Low Conga	Low Conga	Low Conga	Car-Stop
65	High Timbale	High Timbale	High Timbale	High Timbale	Car-Pass
66	Low Timbale	Low Timbale	Low Timbale	Low Timbale	Car-Crash
67	High Agogo	High Agogo	High Agogo	High Agogo	Siren
68	Low Agogo	Low Agogo	Low Agogo	Low Agogo	Train
69	Cabasa	Cabasa	Cabasa	Cabasa	Jetplane
70	Ana.Maracas	Maracas	Maracas	Maracas	Helicopter
71	ShortWhistle [M2]	ShortWhistle [M2]	ShortWhistle [M2]	ShortWhistle [M2]	Starship
C5	----	----	----	----	----
72	Long Whistle [M2]	Long Whistle [M2]	Long Whistle [M2]	Long Whistle [M2]	Gun Shot
73	Short Guiro [M3]	Short Guiro [M3]	Short Guiro [M3]	Short Guiro [M3]	Machine Gun
74	Long Guiro [M3]	Long Guiro [M3]	Long Guiro [M3]	Long Guiro [M3]	Lasergun
75	Ana.Claves	Claves	Claves	Claves	Explosion
76	Hi WoodBlock	Hi WoodBlock	Hi WoodBlock	Hi WoodBlock	Dog
	LowWoodBlock	LowWoodBlock	LowWoodBlock	LowWoodBlock	Horse-Gallop
77	Mute Cuica [M4]	Mute Cuica [M4]	Mute Cuica [M4]	Mute Cuica [M4]	Birds
78	Open Cuica [M4]	Open Cuica [M4]	Open Cuica [M4]	Open Cuica [M4]	Rain
79	MuteTriangle [M5]	MuteTriangle [M5]	MuteTriangle [M5]	MuteTriangle [M5]	Thunder
80	OpenTriangle [M5]	OpenTriangle [M5]	OpenTriangle [M5]	OpenTriangle [M5]	Wind
81	Shaker	Shaker	Shaker	Shaker	Seashore
82	Jingle Bell	Jingle Bell	Jingle Bell	Jingle Bell	Stream
83	----	----	----	----	----
C6	----	----	----	----	----
84	Bell Tree	Bell Tree	Bell Tree	Bell Tree	Bubble
85	Castanets	Castanets	Castanets	Castanets	----
86	Mute Surdo [M6]	Mute Surdo [M6]	Mute Surdo [M6]	Mute Surdo [M6]	----
87	Open Surdo [M6]	Open Surdo [M6]	Open Surdo [M6]	Open Surdo [M6]	----
88	----	----	----	Applause	----
89	----	----	----	----	----
90	----	----	----	----	----
91	----	----	----	----	----
92	----	----	----	----	----
93	----	----	----	----	----
94	----	----	----	----	----
95	----	----	----	----	----
C7	----	----	----	----	----
96	----	----	----	----	----
97	----	----	----	----	----
98	----	----	----	----	----
99	----	----	----	----	----
100	----	----	----	----	----
101	----	----	----	----	----
102	----	----	----	----	----
103	----	----	----	----	----
104	----	----	----	----	----
105	----	----	----	----	----
106	----	----	----	----	----
107	----	----	----	----	----
C8	----	----	----	----	----
108	----	----	----	----	----

---- : no sound

[M]: will not sound simultaneously with other percussion instruments of the same number

Rhythm Pattern List

No.	Group	Pattern	No.	Group	Pattern	No.	Group	Pattern	No.	Group	Pattern
001	Pop 1	1-a (120)	009	Pop 8	9-a (125)	017	R&B	1 (140)	025	6/8 SlwJazzWaltz	1-a (80)
		1-b (120)			9-b (125)			2 (140)			1-b (80)
		1-c (120)			9-c (125)			3 (140)			1-c (80)
		1-d (120)			9-d (125)			4 (140)			1-d (80)
		1-e (120)			9-e (125)			5 (140)			2-a (80)
		1-f (120)			9-f (125)			6 (140)			2-b (80)
		1-g (120)			9-g (125)			7 (140)			2-c (80)
		1-h (120)			9-h (125)			8 (140)			2-d (80)
002	Pop 2	2-a (120)	010	Rock 1	1-a (120)	018	Reggae	1 (105)	026	6/8 Shuffle	1-a (90)
		2-b (120)			1-b (120)			2 (94)			1-b (90)
		2-c (120)			1-c (120)			3 (94)			1-c (90)
		2-d (120)			1-d (120)			4 (90)			1-d (90)
		2-e (120)			1-e (120)			5 (89)			2-a (90)
		2-f (120)			1-f (120)			6 (105)			2-b (90)
		2-g (120)			1-g (120)			7 (105)			2-c (90)
		2-h (120)			1-h (120)			8 (100)			2-d (90)
003	Pop 3	3-a (150)	011	Rock 2	2-a (114)	019	Trance 1	1 (140)	027	6/8 Pop 2	1-a (64)
		3-b (150)			2-b (114)			2 (138)			1-b (64)
		3-c (150)			2-c (114)			3 (142)			1-c (64)
		3-d (150)			2-d (114)			4 (142)			1-d (64)
		3-e (150)			2-e (114)			5 (142)			2-a (64)
		3-f (150)			2-f (114)			6 (142)			2-b (64)
		3-g (150)			2-g (114)			7 (138)			2-c (64)
		3-h (150)			2-h (114)			8 (138)			2-d (64)
004	Pop 4	4-a (120)	012	Funk	1 (115)	020	Trance 2	1 (143)	028	Machine Beat 1	1 (100)
		4-b (120)			2 (115)			2 (142)			2 (100)
		4-c (120)			3 (115)			3 (135)			3 (140)
		4-d (120)			4 (115)			4 (140)			4 (140)
		4-e (120)			5 (115)			5 (130)			5 (160)
		4-f (120)			6 (115)			6 (154)			6 (160)
		4-g (120)			7 (115)			7 (140)			7 (136)
		4-h (120)			8 (115)			8 (138)			8 (160)
005	Pop 5	5-a (103)	013	Fusion	1 (100)	021	House 1	1 (126)	029	Machine Beat 2	1 (130)
		5-b (103)			2 (100)			2 (126)			2 (130)
		5-c (103)			3 (100)			3 (124)			3 (130)
		5-d (103)			4 (100)			4 (128)			4 (140)
		5-e (103)			5 (100)			5 (125)			5 (140)
		5-f (103)			6 (100)			6 (128)			6 (140)
		5-g (103)			7 (100)			7 (126)			7 (175)
		5-h (103)			8 (100)			8 (126)			8 (160)
006	Pop 6	6-a (96)	014	6/8 Jazz	1 (136)	022	House 2	1 (125)	030	Machine Beat 3	1 (130)
		6-b (96)			2 (136)			2 (130)			2 (130)
		6-c (96)			3 (136)			3 (134)			3 (130)
		6-d (96)			4 (136)			4 (127)			4 (130)
		6-e (96)			5 (136)			5 (128)			5 (130)
		6-f (96)			6 (136)			6 (128)			6 (130)
		6-g (96)			7 (136)			7 (128)			7 (130)
		6-h (96)			8 (136)			8 (128)			8 (130)
007	Pop 7	7-a (104)	015	Bossa	1 (160)	023	Drum'n Bs	1 (170)	024	Disco	1 (125)
		7-b (104)			2 (160)			2 (160)			2 (125)
		7-c (104)			3 (160)			3 (180)			3 (125)
		7-d (104)			4 (160)			4 (160)			4 (120)
		7-e (104)			5 (160)			5 (170)			5 (130)
		7-f (104)			6 (160)			6 (170)			6 (124)
		7-g (104)			7 (160)			7 (170)			7 (125)
		7-h (104)			8 (160)			8 (170)			8 (125)
008	6/8 Pop 1	8-a (110)	016	Hip Hop	1 (95)	024	Disco	1 (125)	024	Disco	1 (125)
		8-b (110)			2 (95)			2 (125)			2 (125)
		8-c (110)			3 (95)			3 (125)			3 (125)
		8-d (110)			4 (95)			4 (120)			4 (120)
		8-e (110)			5 (95)			5 (130)			5 (130)
		8-f (110)			6 (95)			6 (124)			6 (124)
		8-g (110)			7 (95)			7 (125)			7 (125)
		8-h (110)			8 (95)			8 (95)			8 (125)

() : Recommended tempo

Pattern List

No.	Name
001	Chiptune 1
002	Chiptune 2
003	Synth Pop 1
004	Synth Pop 2
005	Pop EDM 1
006	Pop EDM 2
007	Pop EDM 3
008	Pop EDM 4

No.	Name
009	Pop EDM 5
010	Pop EDM 6
011	Pop EDM 7
012	Drum&Bass 1
013	Drum&Bass 2
014	Electro.H 1
015	Electro.H 2
016	ProgTrance

No.	Name
017	Electro 1
018	Electro 2
019	TechHouse 1
020	TechHouse 2
021	Trap 1
022	Trap 2
023	Trap 3
024	Trap 4

No.	Name
025	Trap 5
026	Trap 6
027	House 1
028	House 2
029	EDM 1
030	EDM 2
031	EDM 3
032	EDM 4

Arpeggio Style List

No.	Name
001	Basic 1 (a)
002	Basic 2 (a)
003	Basic 3 (a)
004	Basic 4 (a)
005	Basic 5 (a)
006	Basic 6 (a)
007	Seq Ptn 1 (2)
008	Seq Ptn 2 (2)
009	Seq Ptn 3 (2)
010	Seq Ptn 4 (2)
011	Seq Ptn 5 (2)
012	Seq Ptn 6 (3)
013	Seq Ptn 7 (3)
014	Seq Ptn 8 (3)
015	Seq Ptn 9 (3)
016	Seq Ptn 10 (3)
017	Seq Ptn 11 (3)
018	Seq Ptn 12 (3)
019	Seq Ptn 13 (3)
020	Seq Ptn 14 (3)
021	Seq Ptn 15 (3)
022	Seq Ptn 16 (3)
023	Seq Ptn 17 (3)
024	Seq Ptn 18 (4)
025	Seq Ptn 19 (4)
026	Seq Ptn 20 (4)

No.	Name
027	Seq Ptn 21 (4)
028	Seq Ptn 22 (4)
029	Seq Ptn 23 (4)
030	Seq Ptn 24 (4)
031	Seq Ptn 25 (4)
032	Seq Ptn 26 (4)
033	Seq Ptn 27 (4)
034	Seq Ptn 28 (4)
035	Seq Ptn 29 (4)
036	Seq Ptn 30 (5)
037	Seq Ptn 31 (5)
038	Seq Ptn 32 (6)
039	Seq Ptn 33 (p)
040	Seq Ptn 34 (p)
041	Seq Ptn 35 (p)
042	Seq Ptn 36 (p)
043	Seq Ptn 37 (p)
044	Seq Ptn 38 (p)
045	Seq Ptn 39 (p)
046	Seq Ptn 40 (p)
047	Seq Ptn 41 (p)
048	Seq Ptn 42 (p)
049	Seq Ptn 43 (p)
050	Seq Ptn 44 (p)
051	Seq Ptn 45 (p)
052	Seq Ptn 46 (p)

No.	Name
053	Seq Ptn 47 (p)
054	Seq Ptn 48 (p)
055	Seq Ptn 49 (p)
056	Seq Ptn 50 (p)
057	Seq Ptn 51 (p)
058	Seq Ptn 52 (p)
059	Seq Ptn 53 (p)
060	Seq Ptn 54 (p)
061	Seq Ptn 55 (p)
062	Seq Ptn 56 (p)
063	Seq Ptn 57 (p)
064	Seq Ptn 58 (p)
065	Seq Ptn 59 (p)
066	Seq Ptn 60 (p)
067	Bassline 1 (1)
068	Bassline 2 (1)
069	Bassline 3 (1)
070	Bassline 4 (1)
071	Bassline 5 (1)
072	Bassline 6 (1)
073	Bassline 7 (1)
074	Bassline 8 (1)
075	Bassline 9 (1)
076	Bassline 10 (2)
077	Bassline 11 (2)
078	Bassline 12 (2)

No.	Name
079	Bassline 13 (2)
080	Bassline 14 (2)
081	Bassline 15 (2)
082	Bassline 16 (3)
083	Bassline 17 (3)
084	Bassline 18 (3)
085	Bassline 19 (3)
086	Bassline 20 (3)
087	Bassline 21 (3)
088	Bassline 22 (p)
089	Bassline 23 (p)
090	Bassline 24 (p)
091	Bassline 25 (p)
092	Bassline 26 (p)
093	Bassline 27 (p)
094	Bassline 28 (p)
095	Bassline 29 (p)
096	Bassline 30 (p)
097	Bassline 31 (p)
098	Bassline 32 (p)
099	Bassline 33 (p)
100	Bassline 34 (p)
101	Bassline 35 (p)
102	Bassline 36 (p)
103	Bassline 37 (p)
104	Bassline 38 (p)

No.	Name
105	Bassline 39 (p)
106	Bassline 40 (p)
107	Bassline 41 (p)
108	Sliced 1 (a)
109	Sliced 2 (a)
110	Sliced 3 (a)
111	Sliced 4 (a)
112	Sliced 5 (a)
113	Sliced 6 (a)
114	Sliced 7 (a)
115	Sliced 8 (a)
116	Sliced 9 (a)
117	Sliced 10 (a)
118	Gtr Arp 1 (4)
119	Gtr Arp 2 (5)
120	Gtr Arp 3 (6)
121	Gtr Backing 1(a)
122	Gtr Backing 2(a)
123	Key Bckng1 (a)
124	Key Bckng2 (a)
125	Key Bckng3 (1-3)
126	1/1 Note Trg (1)
127	1/2 Note Trg (1)
128	1/4 Note Trg (1)

Recommended number of notes to press

- (1)–(6) : One to six notes
- (1-3) : One bass note + three-note chord
- (a) : As desired
- (p) : One note, with Motif (p. 29) set to "Phrase"

Vocoder/Auto Pitch List

No.	Name
Mode: Vocoder	
001	Voc:Ensmble
002	Voc:5thStack
003	Voc:Robot
004	Voc:Saw
005	Voc:Sqr
006	Voc:RiseUp
007	Voc:AutoVib
008	Voc:PitchEnv
009	Voc:Choir
010	Voc:Noise

No.	Name
Mode: Auto-Pitch	
011	AP:Elct Pch1
012	AP:Elct Pch2
013	AP:Hard Pch
014	AP:Soft Pch1
015	AP:Formant +
016	AP:Formant -
017	AP:Octave +
018	AP:Octave -
019	AP:toSoprano
020	AP:to Bass

Placing This Unit on a Stand

Be careful not to pinch your fingers when setting up the stand.

* When using the KS-18Z and KS-J8, ensure that the height of the unit is one meter or lower.

If you're using the 61-key model

If you want to place the 61-key model on a stand, please use the KS-12 or KS-18Z stands manufactured by Roland.

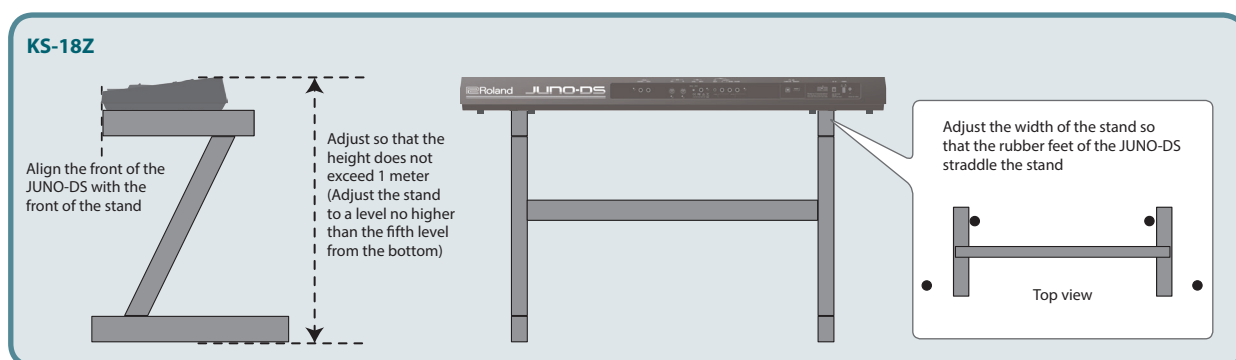
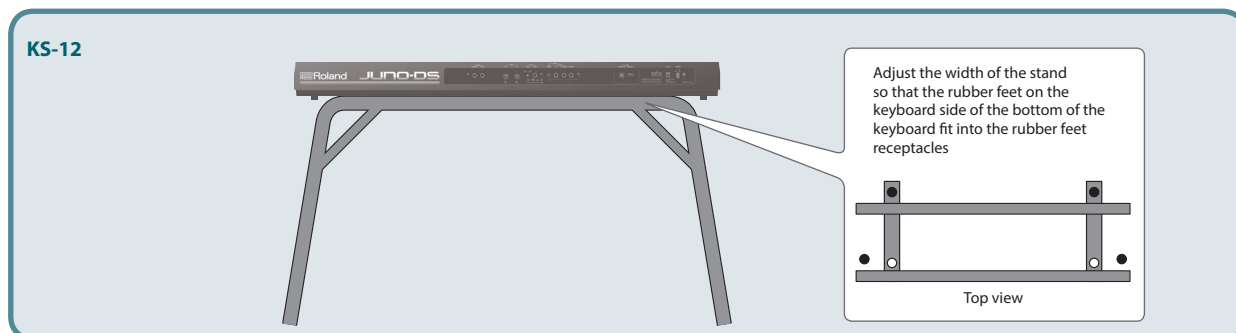

If you're using the 88-key model

If you want to place the 88-key model on a stand, please use the KS-12, KS-18Z, KS-J8, or KS-G8B stands manufactured by Roland.

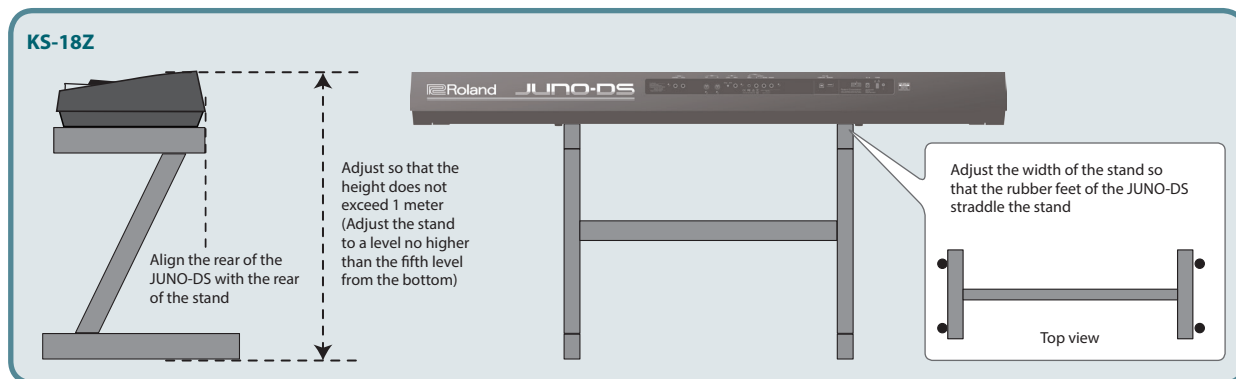
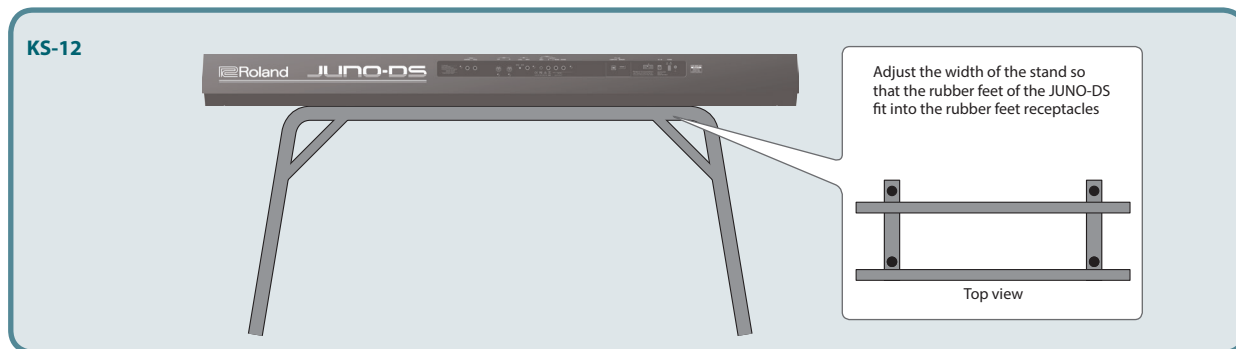

KS-G8B

Align the front of the JUNO-DS with the rubber base of the stand

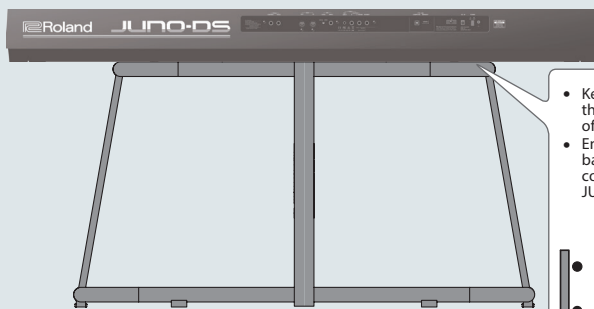
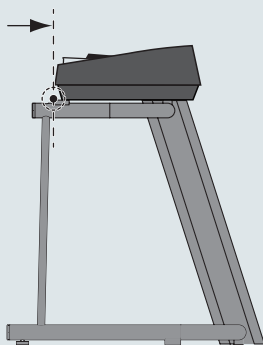

- Keep the rubber feet of the JUNO-DS on the inside of the stand
 - Ensure that the rubber base of the stand does not contact the screws of the JUNO-DS
- 
- Top view